

VULTEE "VANGUARD" 61

ENTIRE NOSE SHAPED FROM Balsa, HALVED, THEN HOLLOWED OUT

CARVED FROM Balsa BLOCK

CELLULOID

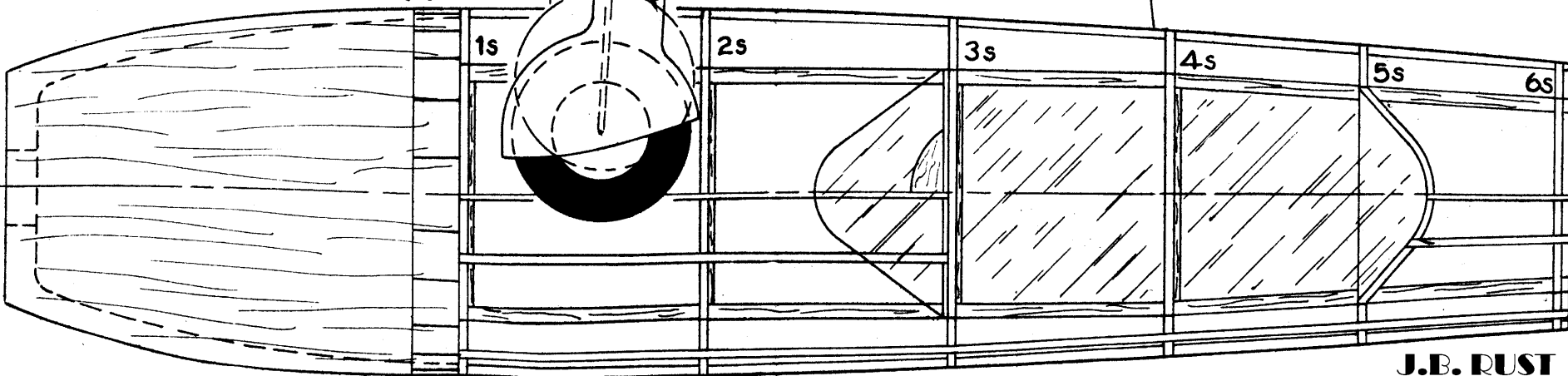
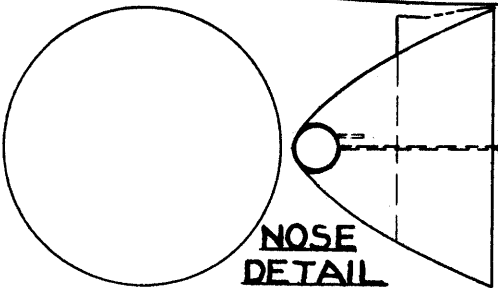
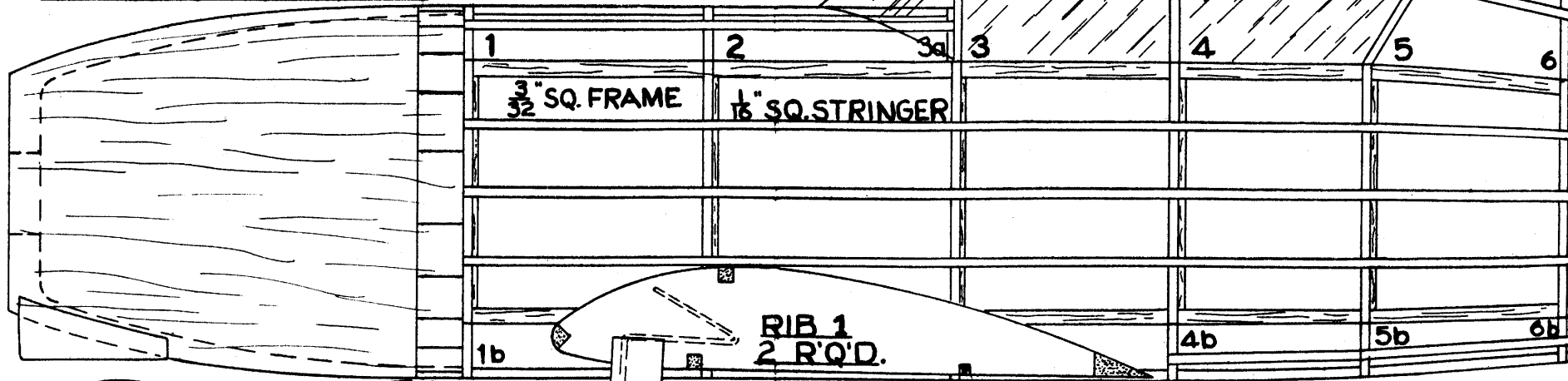

NOTE: THE ENDS OF THE RUDDER AND STABILIZER SPARS ARE INSERTED IN THE TAIL BLOCK AFTER IT HAS BEEN ATTACHED TO THE FUSELAGE FRAME.

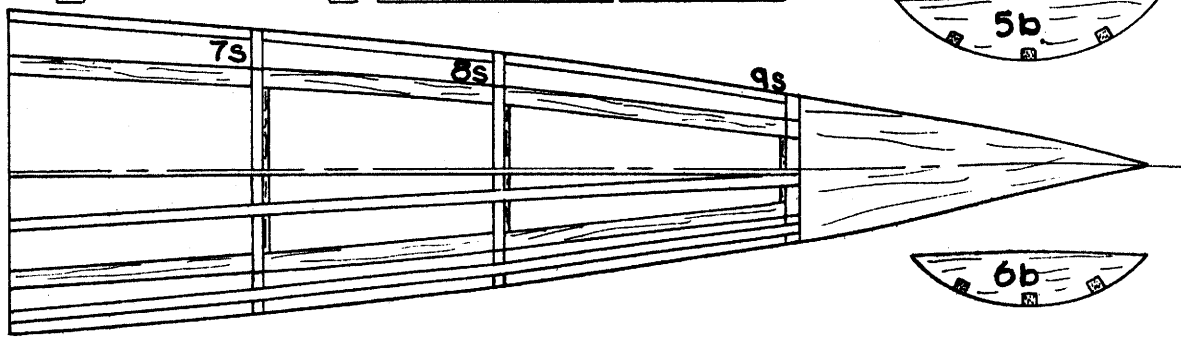
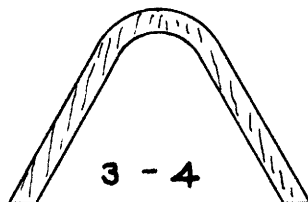
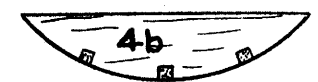
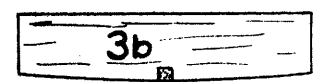
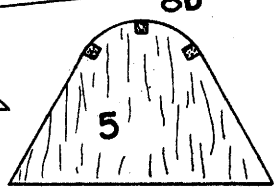
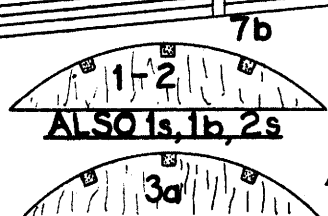
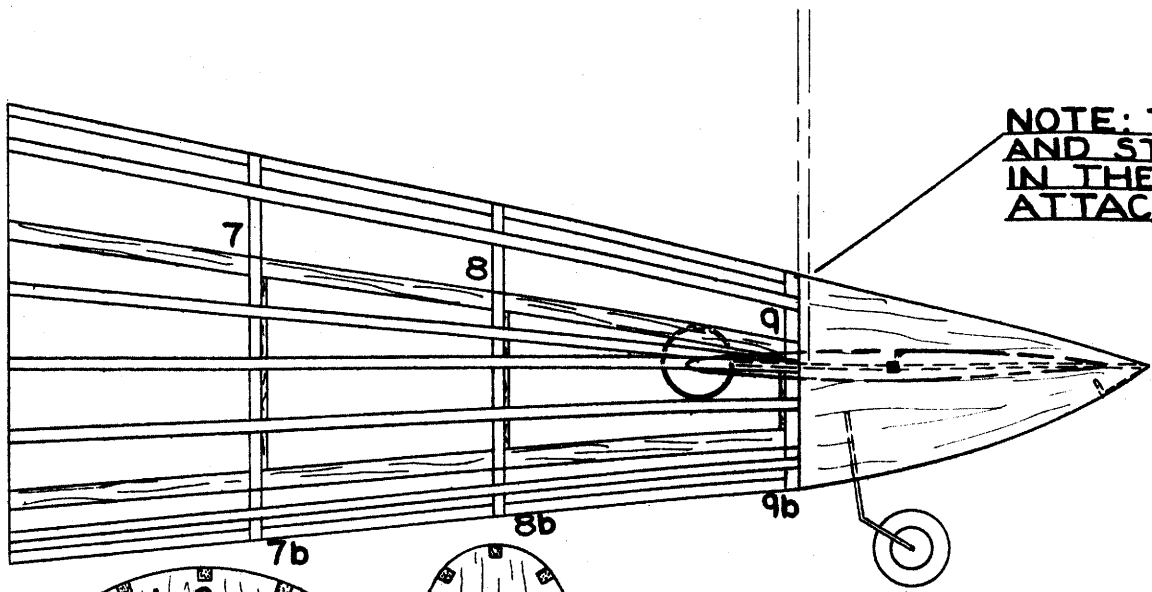

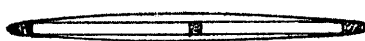
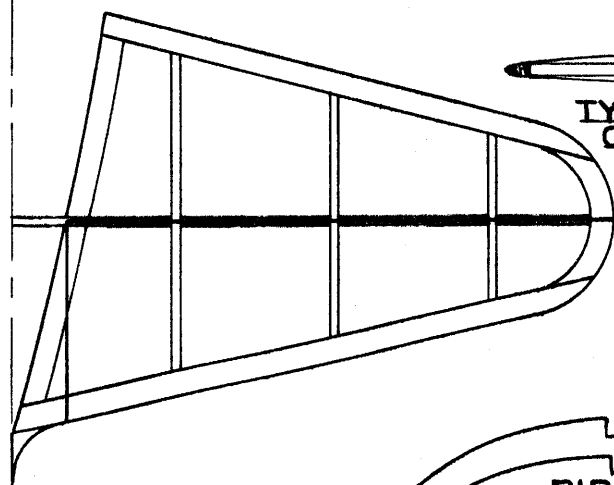
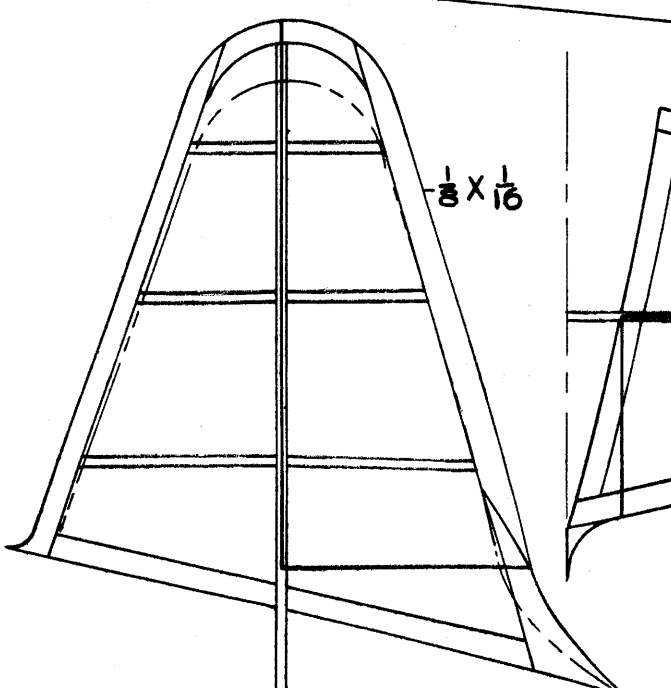
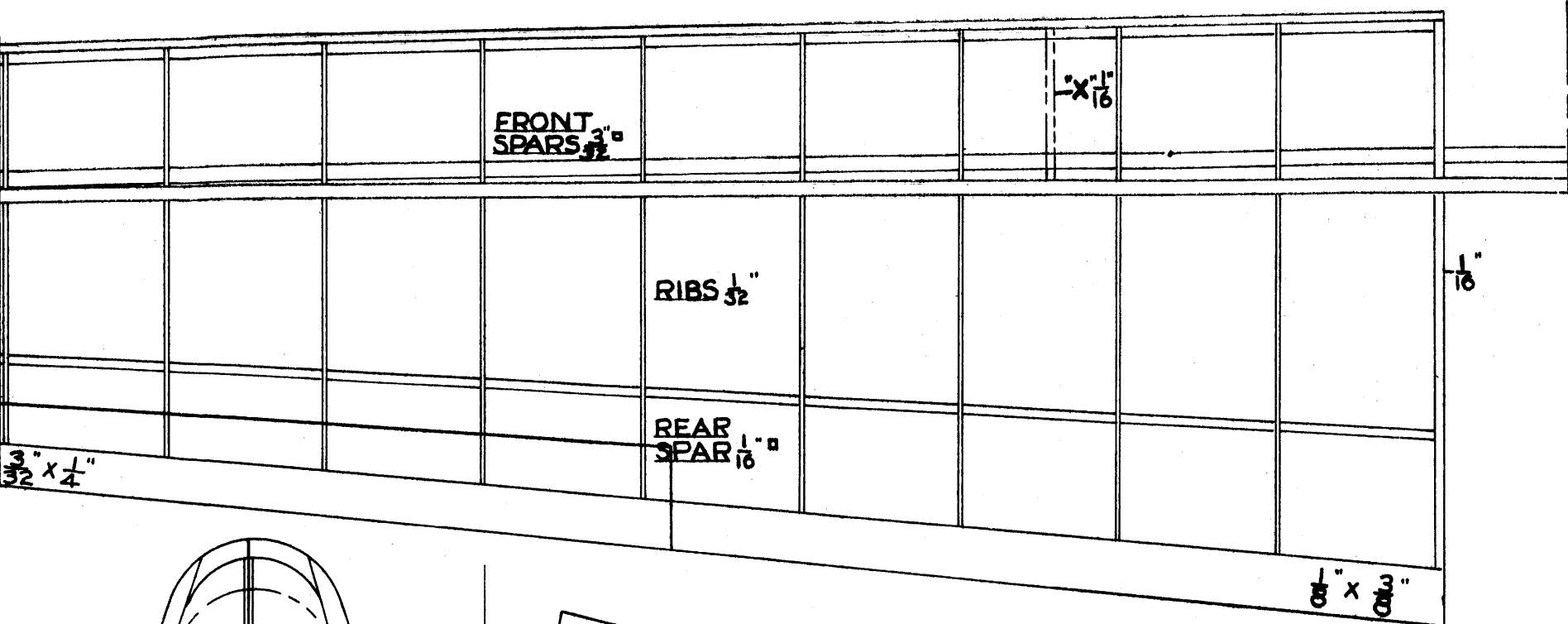

TYPE OF TAIL CONSTRUCTION

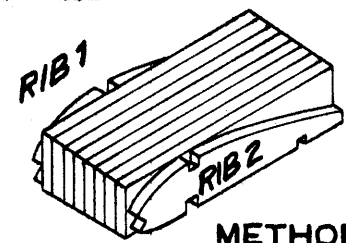

METHOD OF MAKING ACCURATE RIBS FOR TAPERED WING

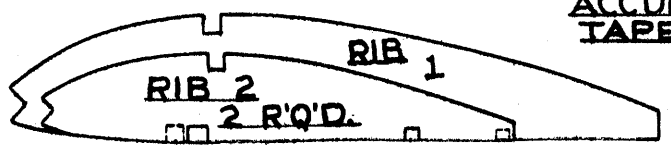

I. PROP BLANK - MAKE 3

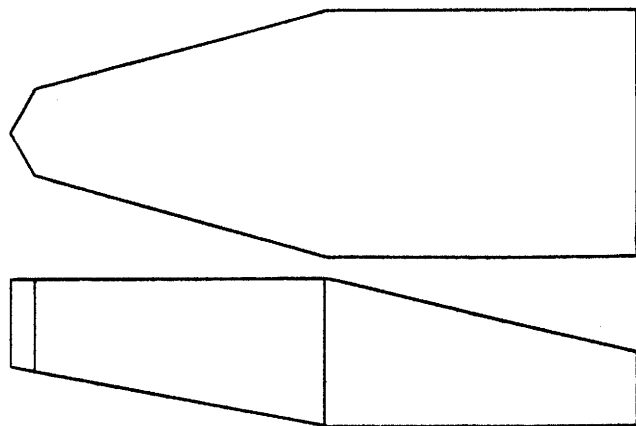

$\frac{1}{16}$ " SHEET
TIPS

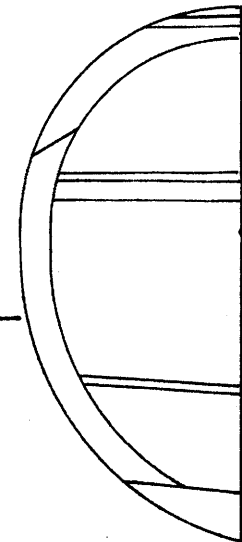

RIB "X"

DIHEDRAL AT TIP-1"

L.G. COVER

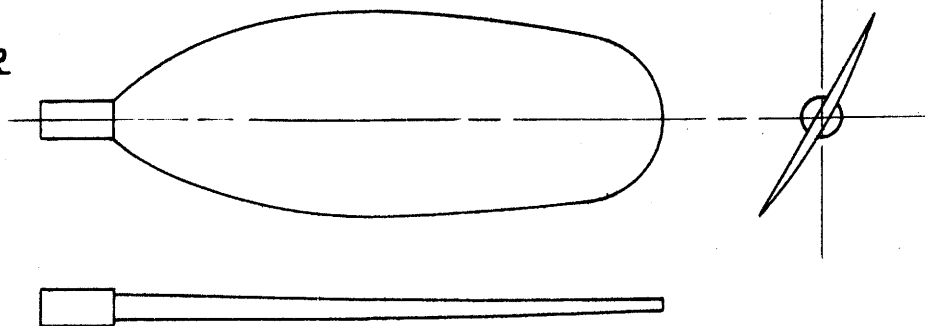

II. BLADE PATTERN - $\frac{1}{8}$ " SHT., MAKE 3

