

TO BUILD IT ~ FOLLOW THESE STEPS

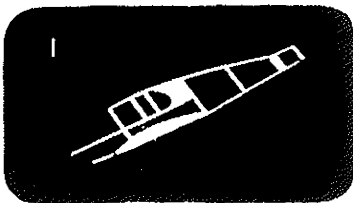

BUILD THE FUSELAGE SIDES ON THE SHADED LAYOUT BELOW. PUT WAX PAPER OVER THE PLAN FIRST TO KEEP THE GLUE FROM STICKING TO IT. USE STRAIGHT PINS TO HOLD THE STRIPS.

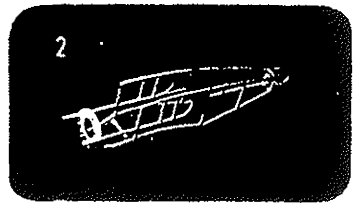

WHEN THE SIDES ARE MADE, GLUE FORMER F4 WHERE IT BELONGS BETWEEN THE TWO SIDES. NOW CEMENT BOTH BACK ENDS TOGETHER.

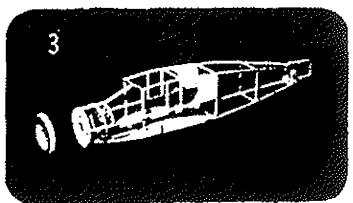

WHILE THAT IS DRYING, CUT THE CROSS-BRACES YOU WILL NEED - 2 OF EACH. [SEE FUSELAGE TOP VIEW] NOW CEMENT THESE WHERE THEY BELONG WITH ALL THE F PARTS---LOOK AT THE SIDE VIEW.

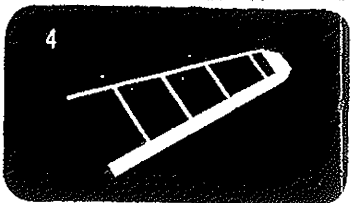

BUILD THE LEFT AND RIGHT WING ON THE LAYOUT. PUT WAX PAPER OVER IT FIRST, THEN PIN DOWN THE LEADING AND TRAILING EDGES. NOW GLUE IN WING TIPS W1 AND W2---THEN ALL THE BASE STRIPS.

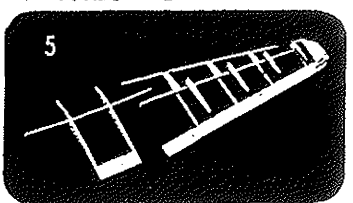

NOW YOU CEMENT ALL THE FRONT RIBS AGAINST THE BASE STRIPS. NEXT, CEMENT THE SPARS AGAINST THE RIBS. THE LAST THING YOU DO IS CEMENT ALL THE BACK RIBS.

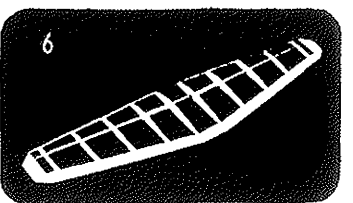

CEMENT WING BRACE W3 TO CENTER RIBS W4 OVER THE LAYOUT AFTER YOU'VE BUILT THE WINGS. GLUE THE TRAILING EDGE PIECE TO IT. WHEN IT'S DRY, CEMENT IT BETWEEN THE WING FRAMES TO FINISH THE WING.

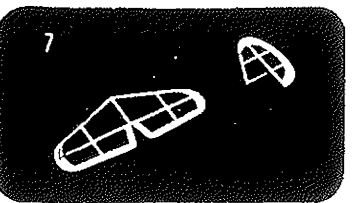

BUILD THE STABILIZER AND RUDDER OVER THE PLAN AS YOU DID THE WING AND FUSELAGE SIDES. ALL OF YOUR AIRPLANE'S FRAMEWORK MUST BE SANDPAPERED A LITTLE BEFORE COVERING IT WITH TISSUE.

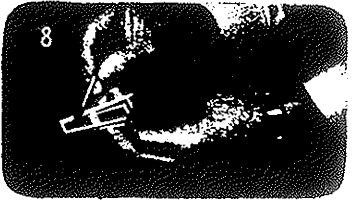

COVER THE RUDDER, STABILIZER, FUSELAGE AND WING WITH TISSUE BEFORE YOU GLUE THESE TOGETHER. USE CLEAR DOPE FOR STICKING THE TISSUE AND COVER ONLY A FEW INCHES AT A TIME. IT DRIES FAST.

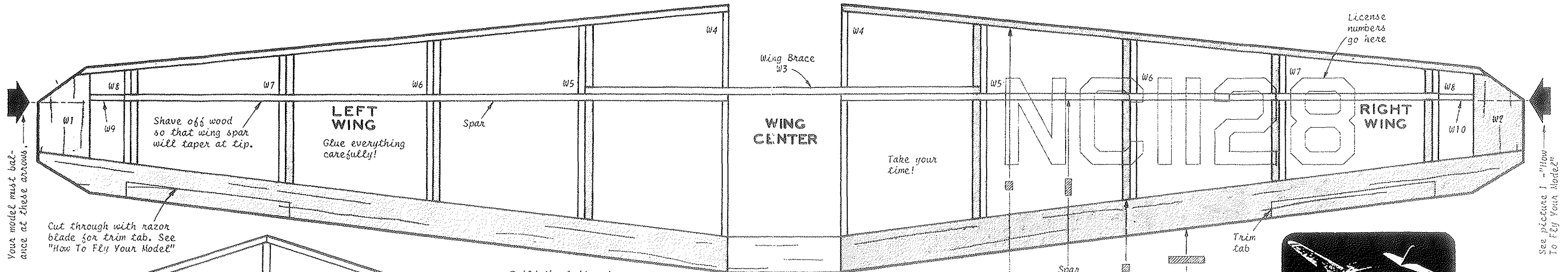

Your model must balance at these arrows.

See picture 1 - "How To Fly Your Model"

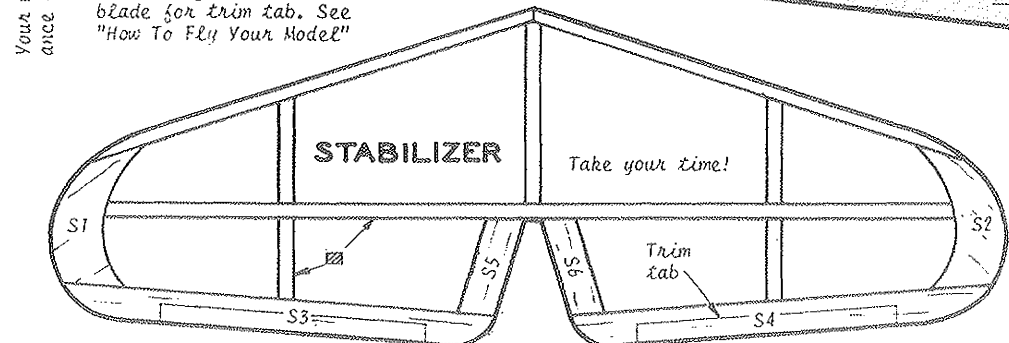

Build the left and right wing frames on this shaded layout. (See picture 4)

Don't try to get it done in one night - you can do a good job by just taking your time!

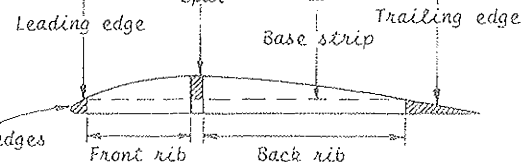

Finish your wing edges with sandpaper.

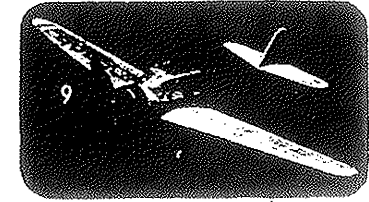

PICTURE OF THE FINISHED BELLANCA JUNIOR MODEL.

Rudder tab for flying adjustment

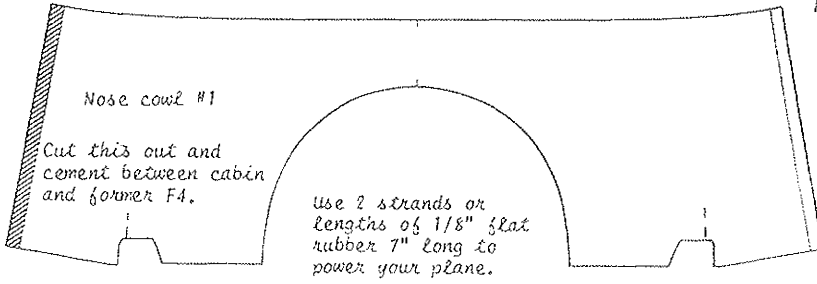

You will need model airplane cement or glue - clear dope for the tissue - straight pins - wax paper and a razor blade for cutting ---- be careful! Also, follow the photo instructions on tissue covering.

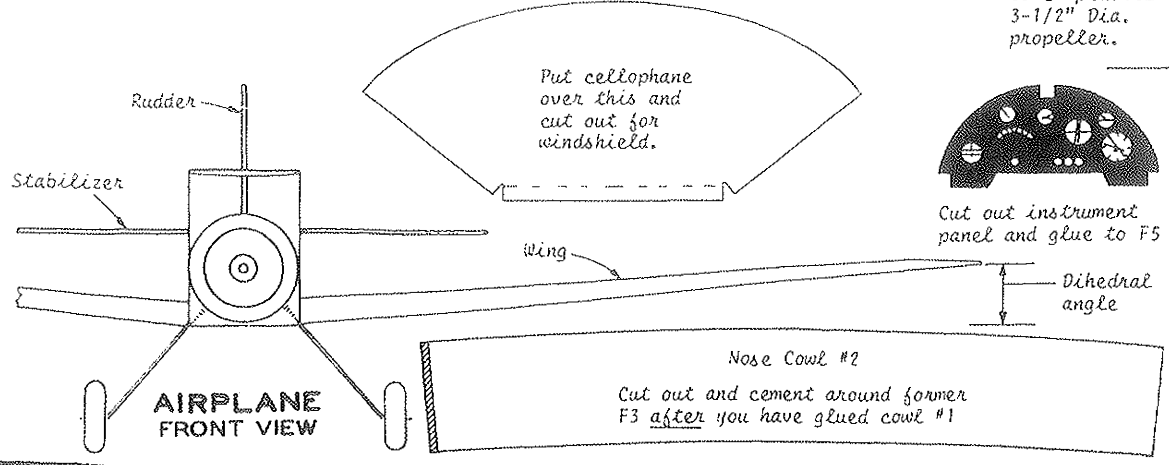
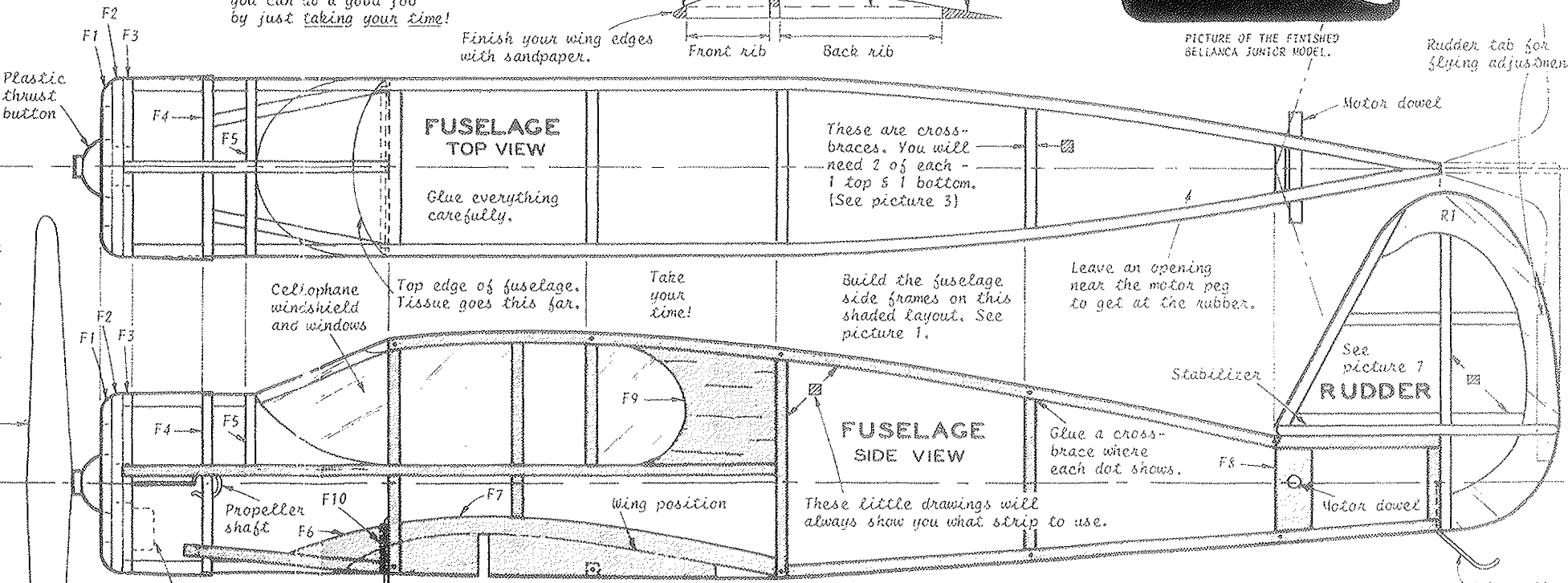

Cement a lead weight behind F3 before you put the tissue on. Part of an empty cement tube will do. Remember - model must balance at arrows.

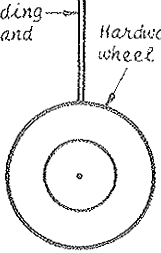

NO 1128

PLAYS FOR
BELLANCA JUNIOR
 WING SPAN 15-1/4" LENGTH 9-13/16"
 KIT NO. 3102 DESIGNED BY Harold Peters
 DRAWN BY Leo Obo

BLELLANCA JR. PARTS SHEET



DUMMY MOTOR
GLUE TO F2

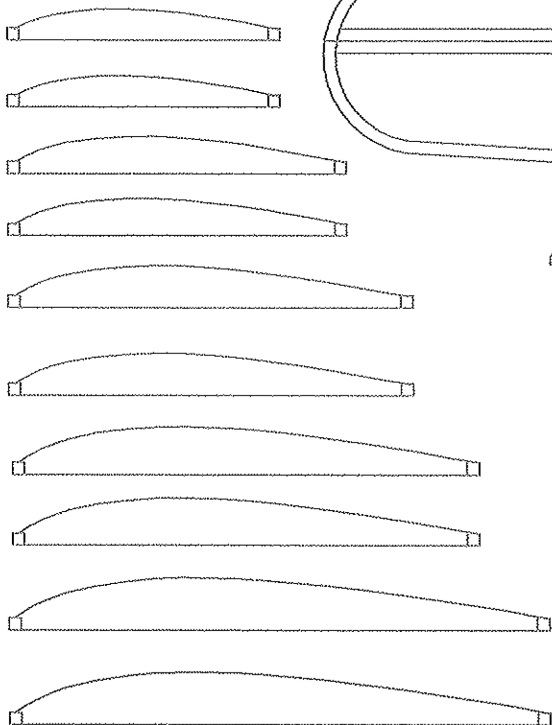
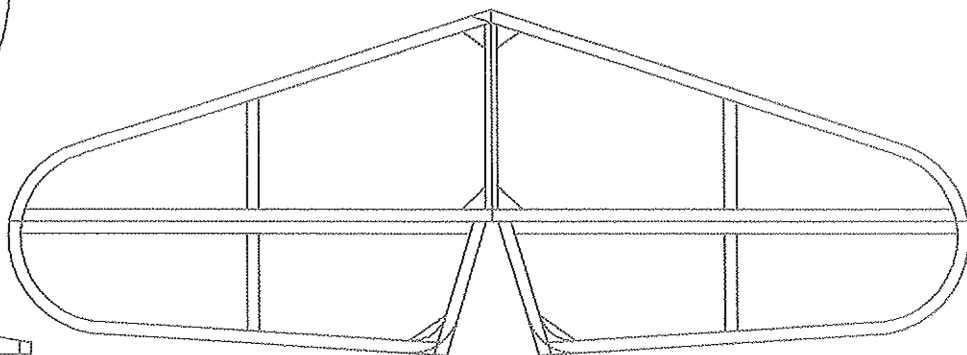
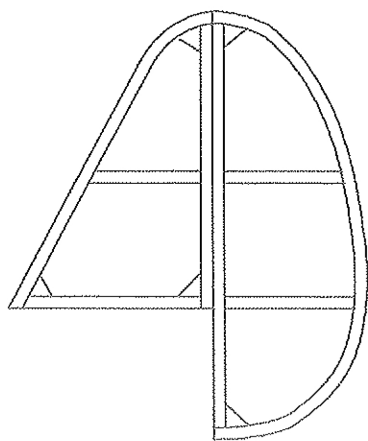
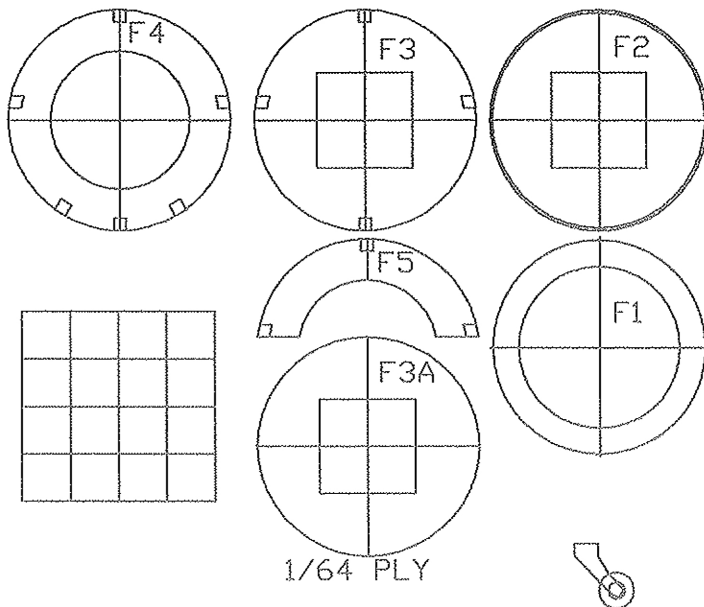

ALL PARTS 1/16 EXCEPT WHERE NOTED.

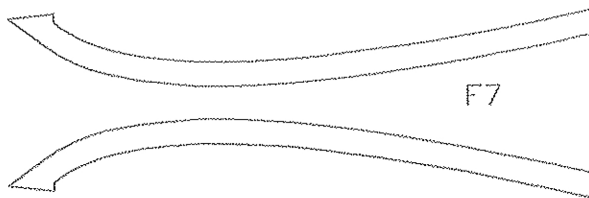

PAPER PATTERN

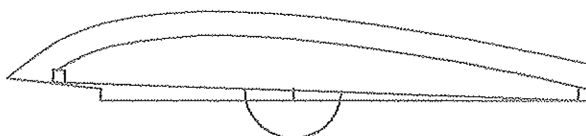

SPAR NOTCH NOT SHOWN
MARK AND SAND IN PLACE
AFTER ASSEMBLY.

WHEEL ACTULLY GLUED TO RIB W5
GLUE THIS PATTERN TO PLAN TO
PROVIDE FOR PROPER WING INCIDENCE.