

A 57" WINGSPAN SPORTS SCALEMODEL FOR 25-40 ENGINES AND 3 CHANNEL RADIO CONTROL.

A.U.W. 300g.  
 CONTROL THROWS:-  
 ALERONS 1/4" UP AND DOWN.  
 ELEVATOR 1/4"-3/8" UP AND DOWN.  
 ALL WOOD Balsa UNLESS OTHERWISE SPECIFIED.

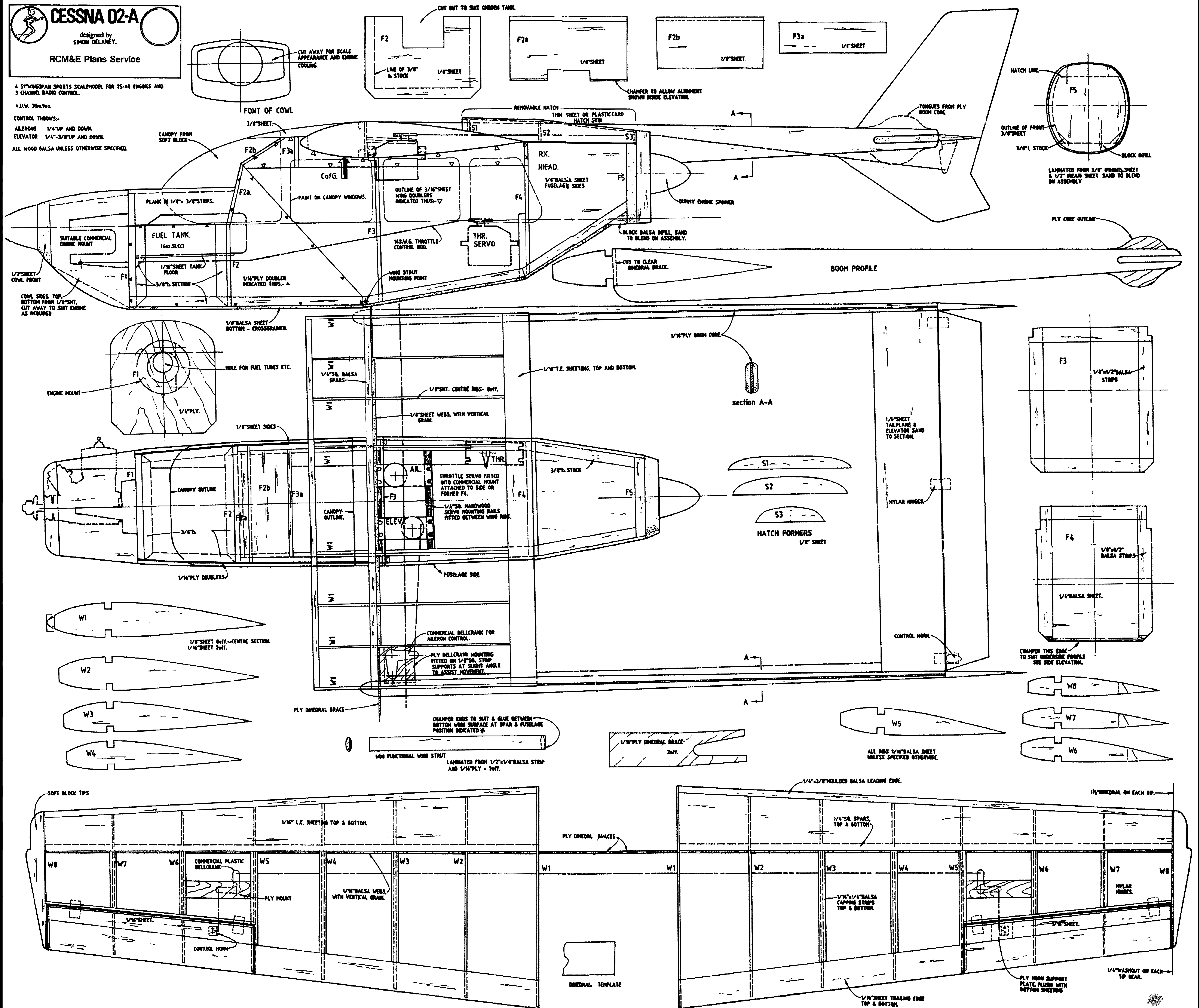

A.U.W. 300g.  
 CONTROL THROWS:-  
 ALERONS 1/4" UP AND DOWN.  
 ELEVATOR 1/4"-3/8" UP AND DOWN.  
 ALL WOOD Balsa UNLESS OTHERWISE SPECIFIED.

COYL SIDES, TOP  
 BOTTOM FROM 1/4" SHIT.  
 CUT AWAY TO SUIT ENGINE  
 AS REQUIRED

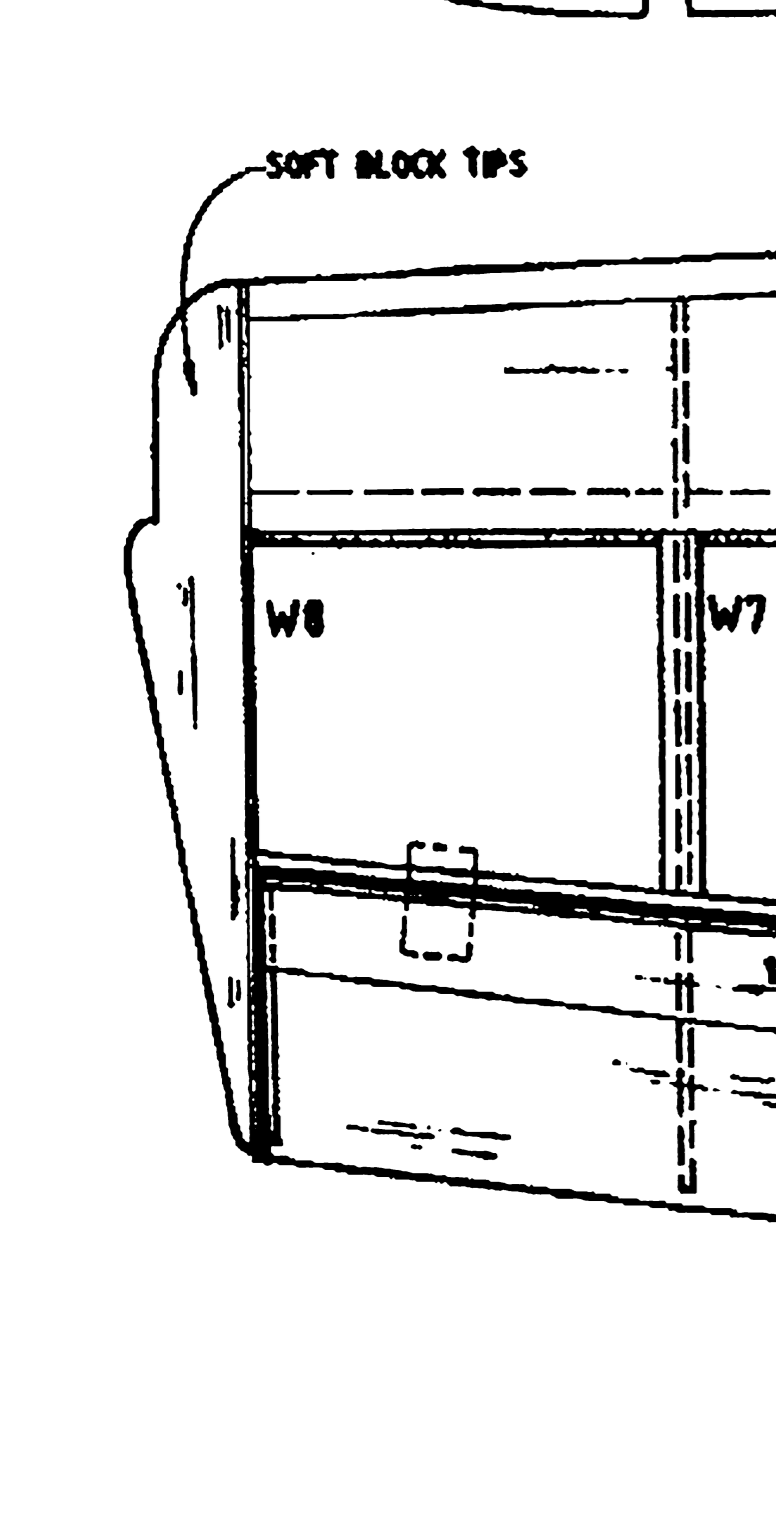
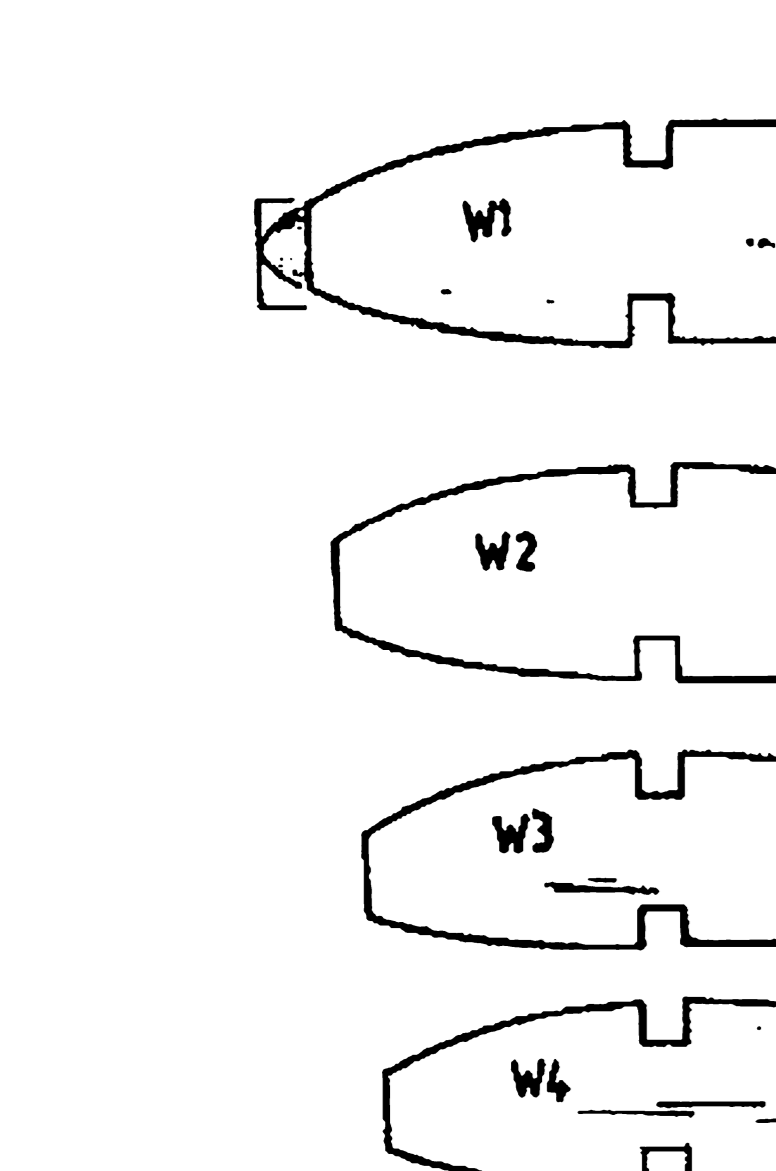
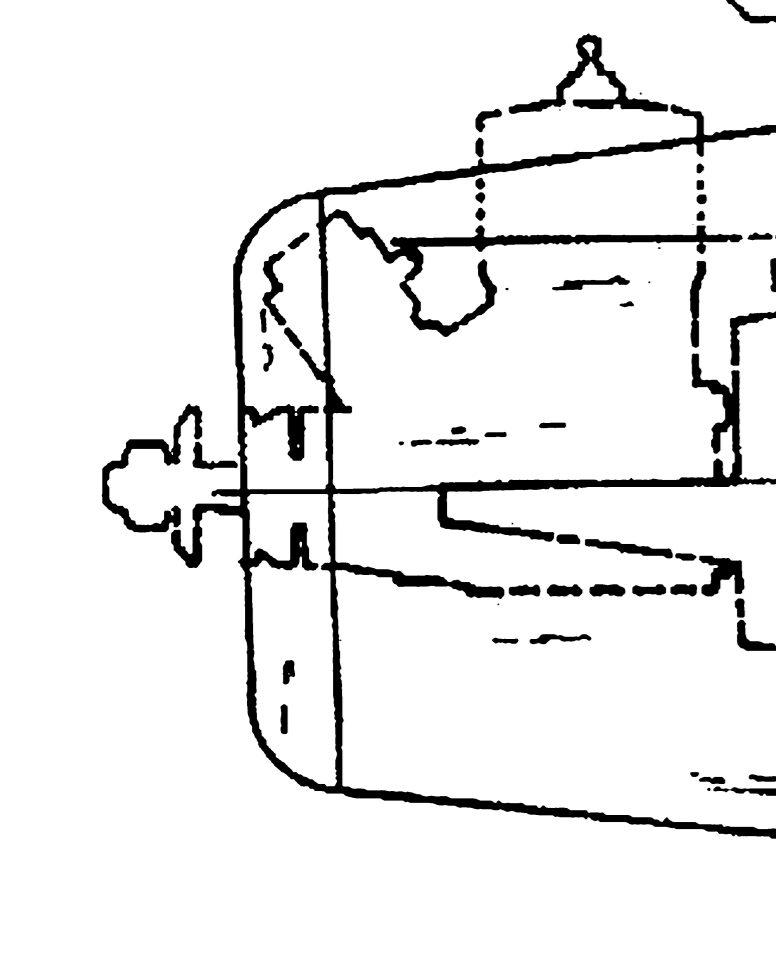
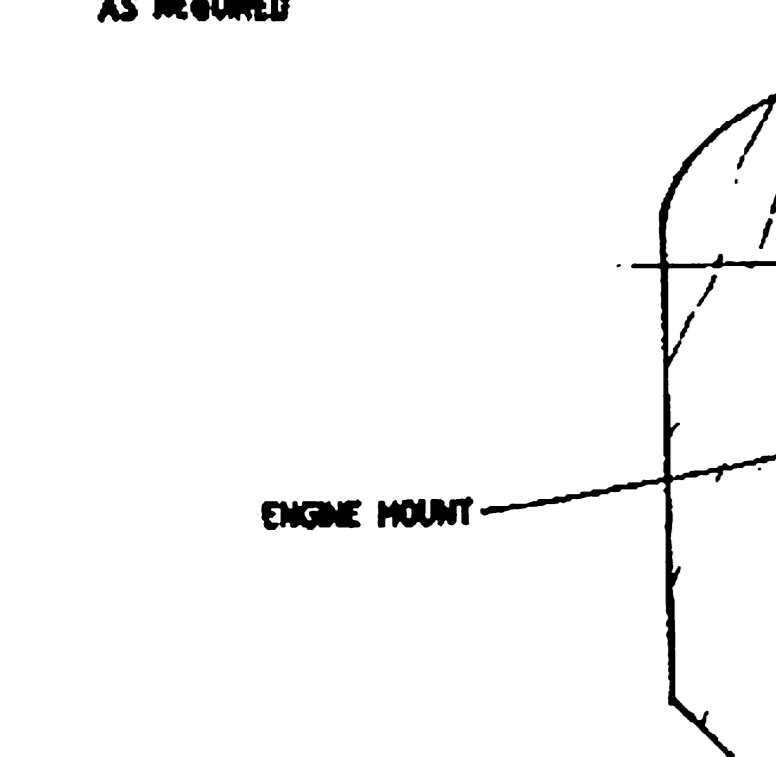

FONT OF COWL  
 3/8" SHEET

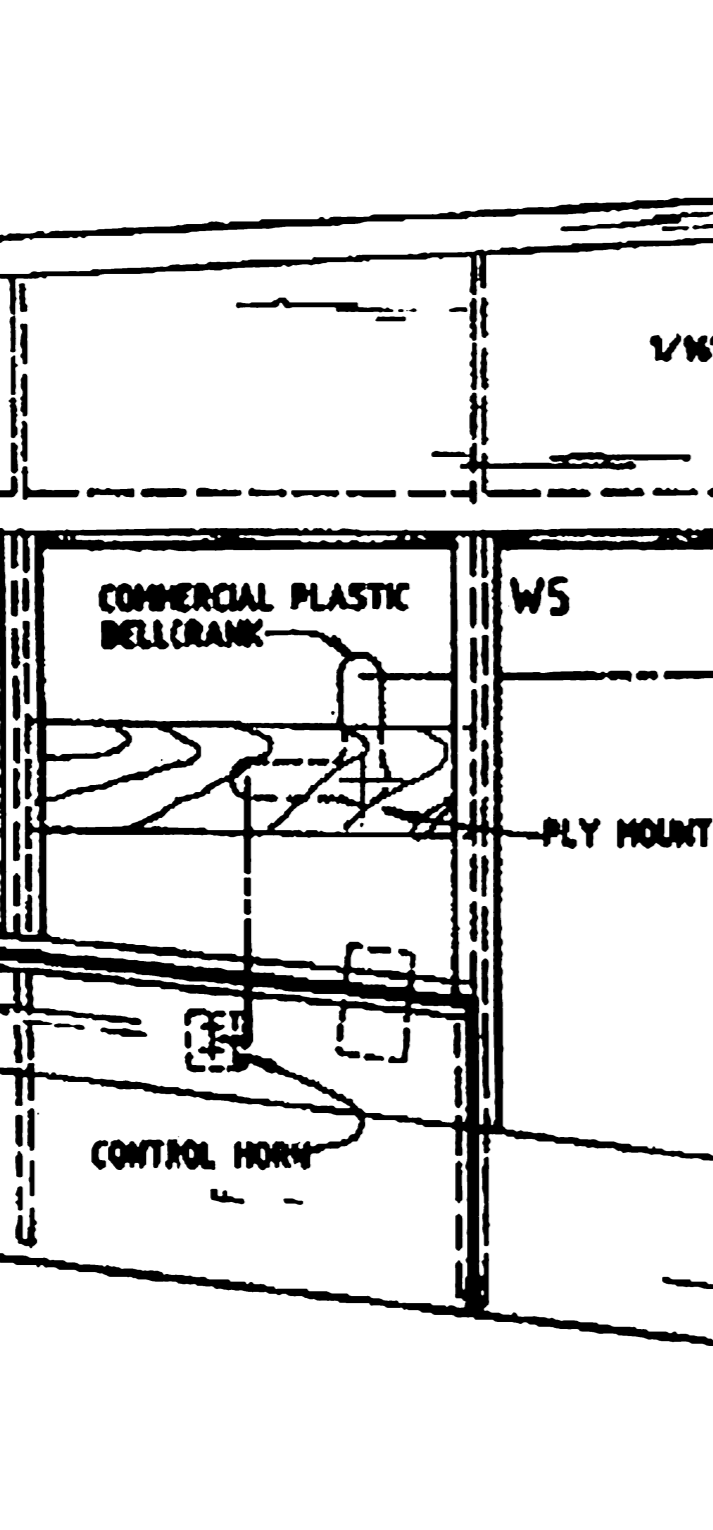
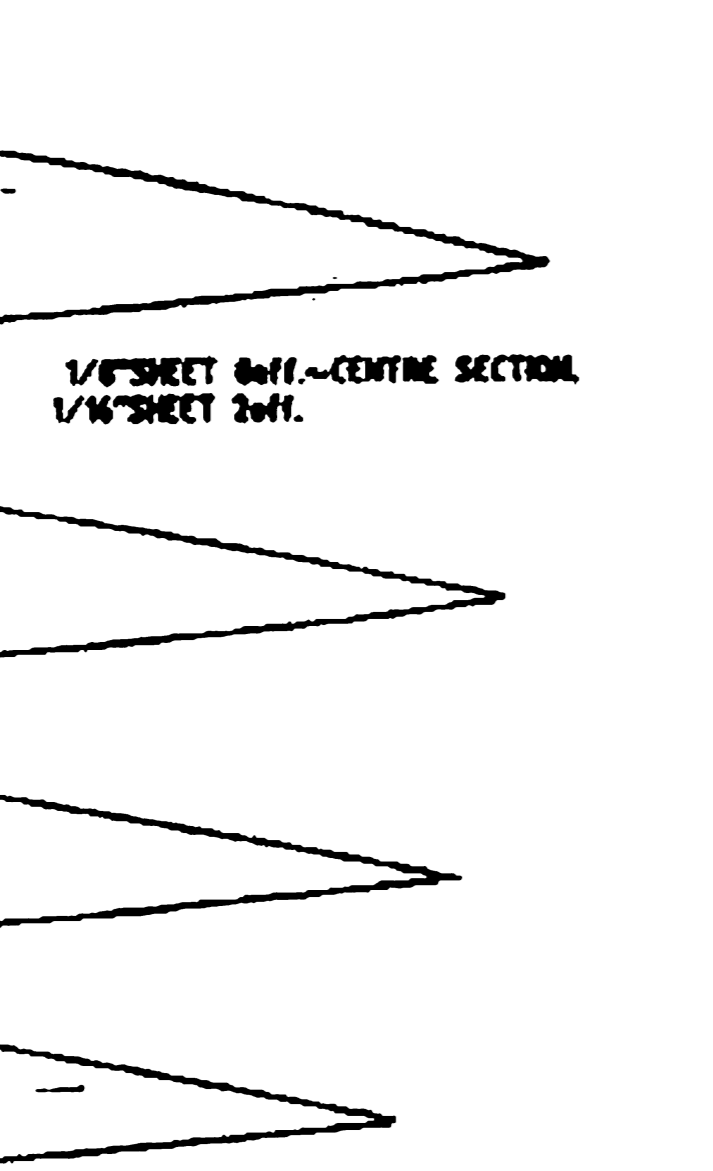
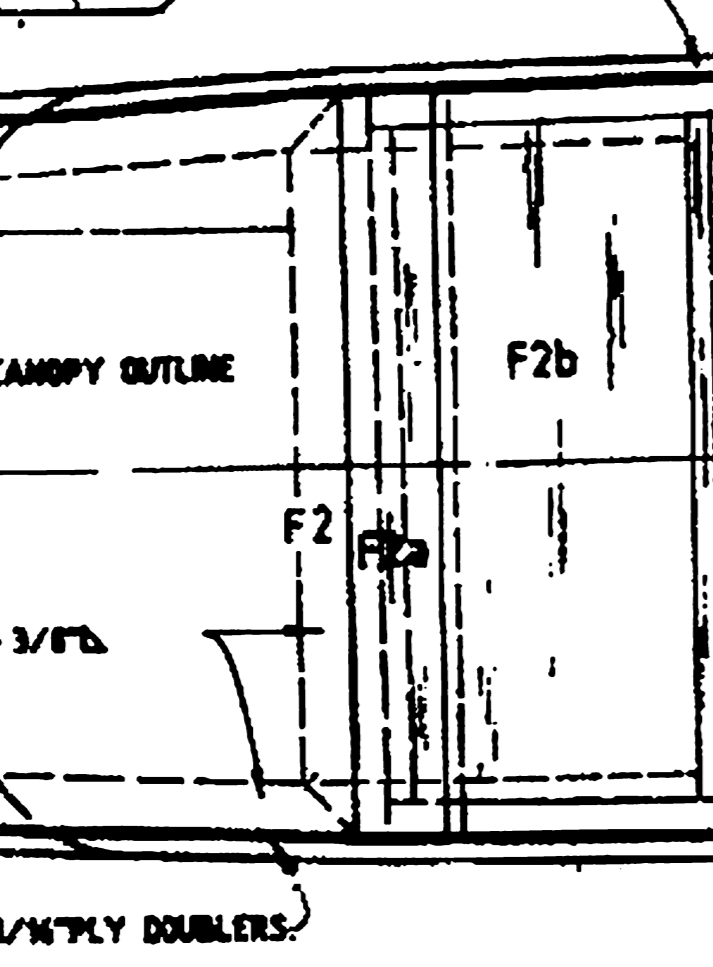
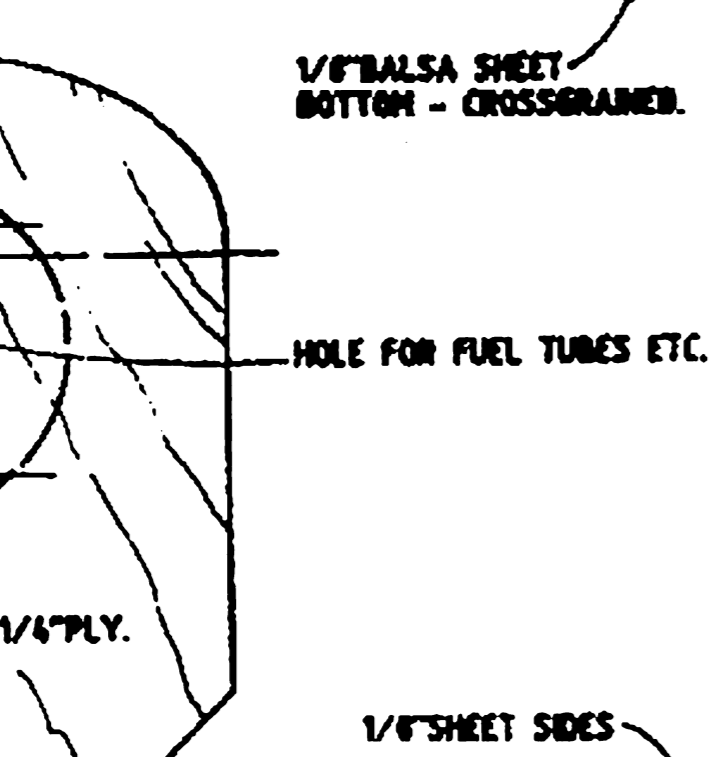
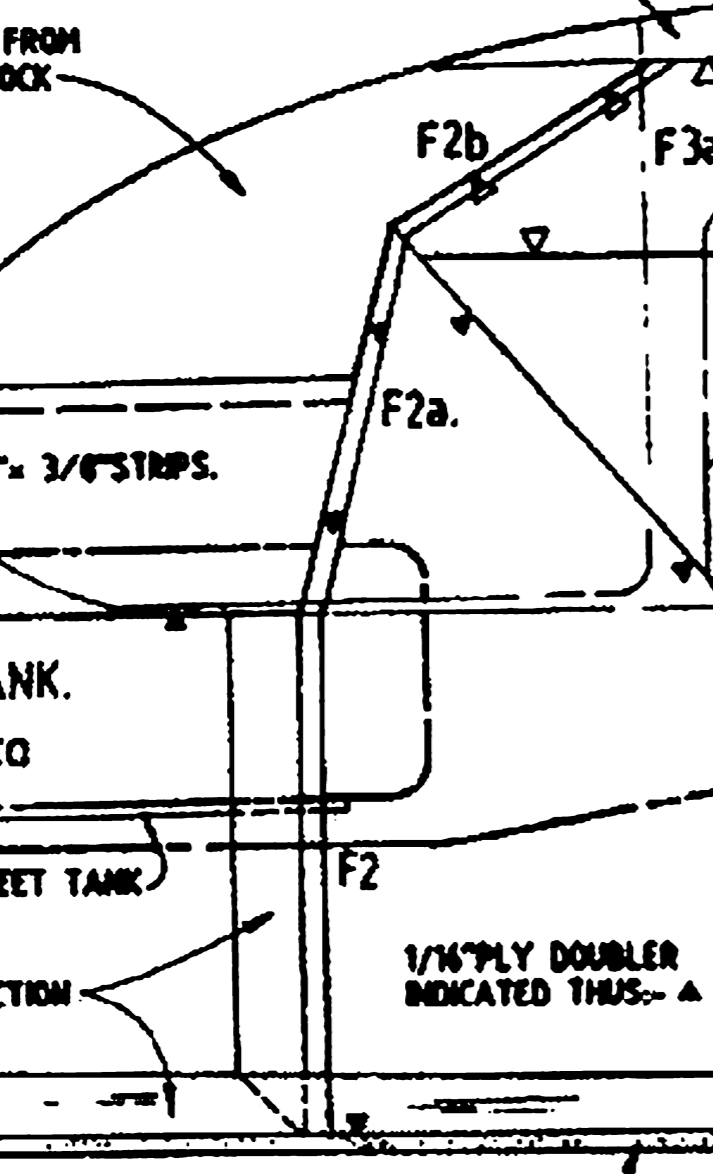

1/8" SHEET

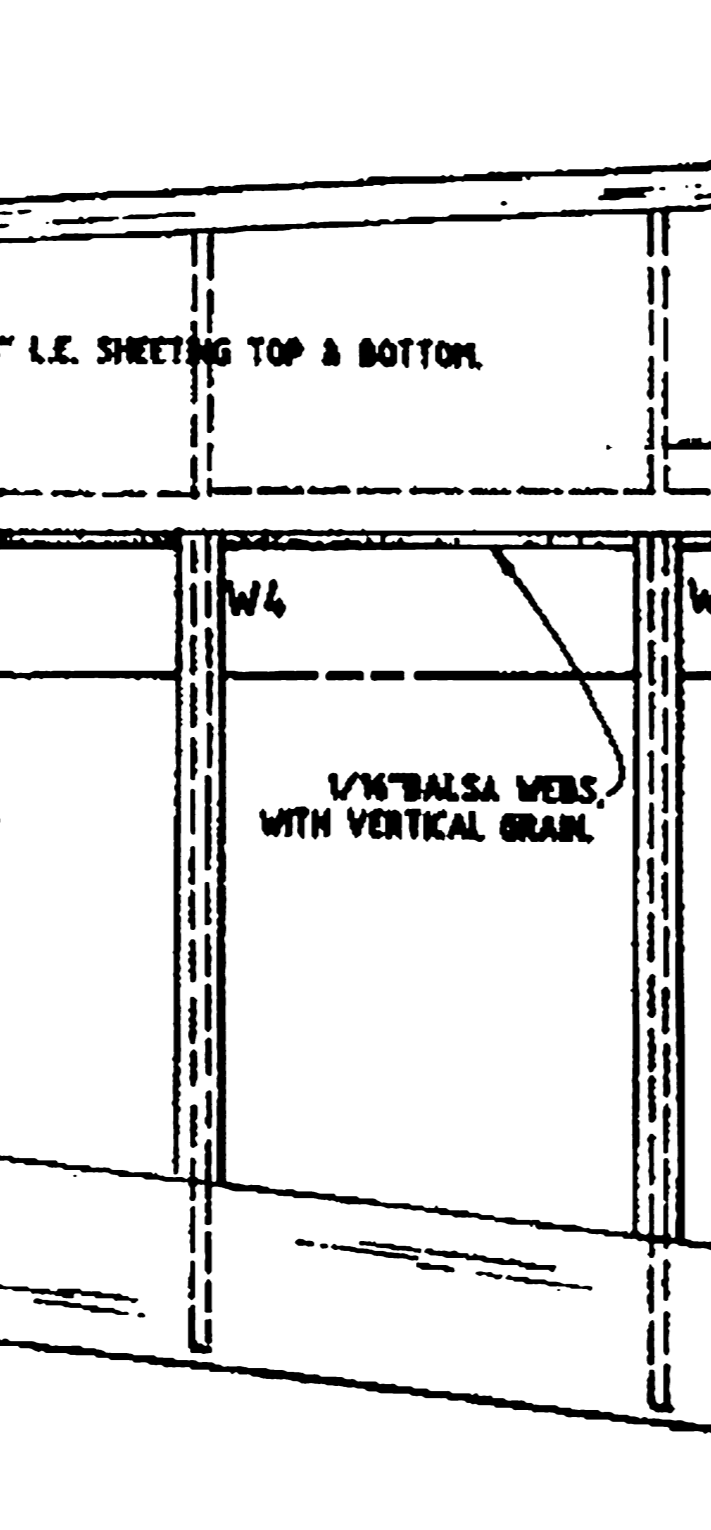
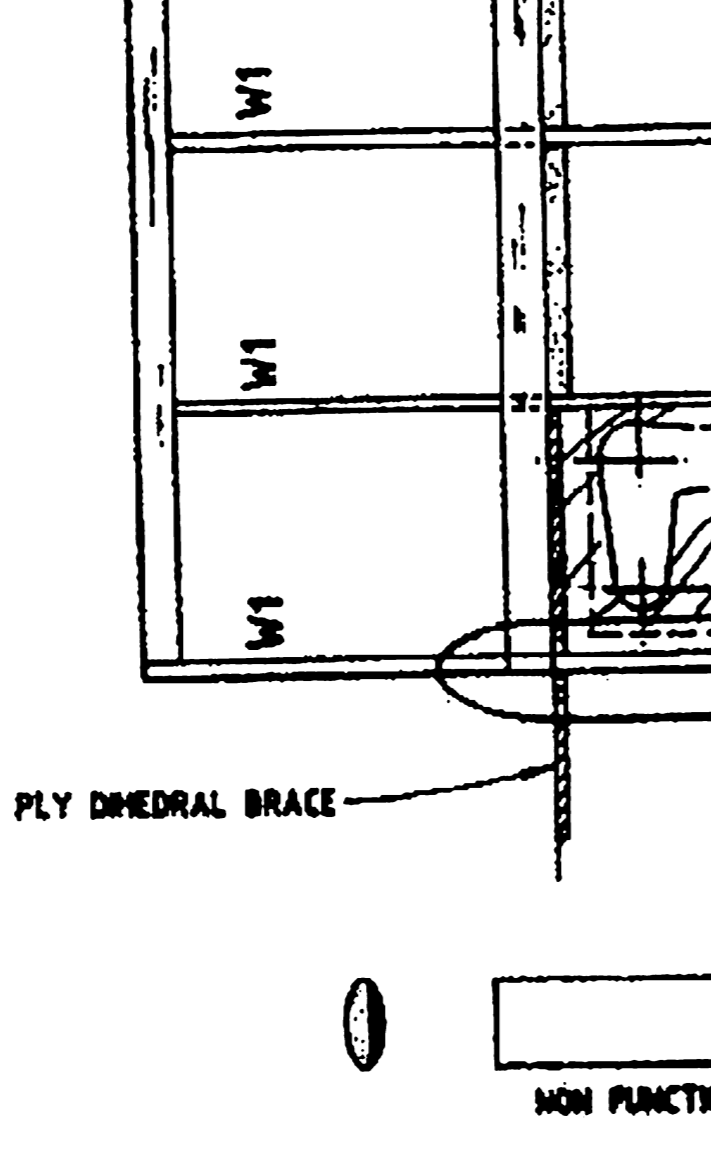
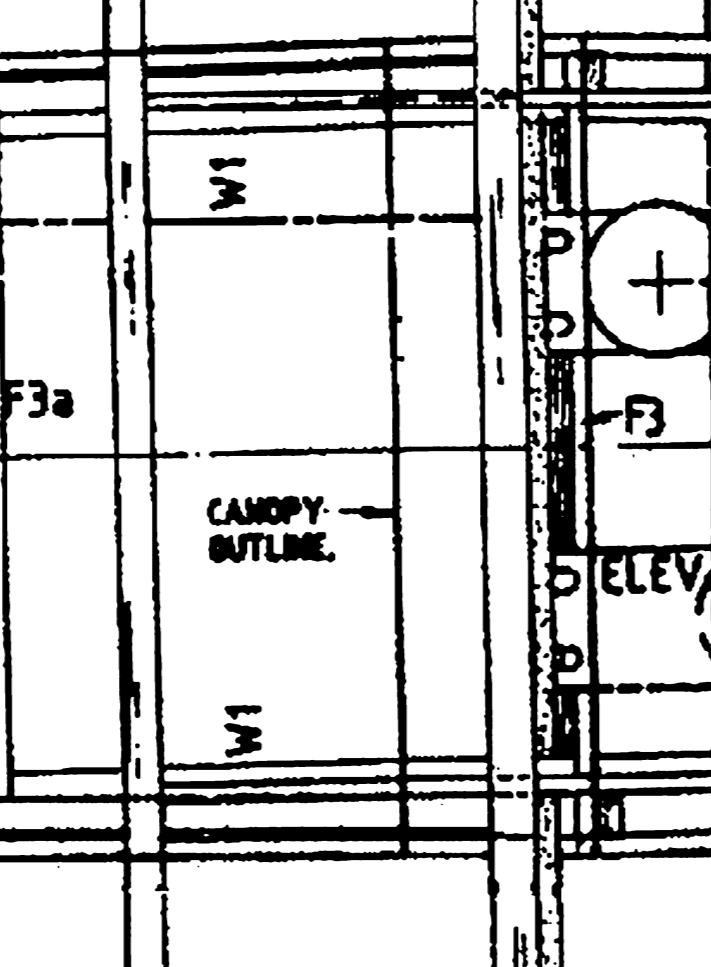
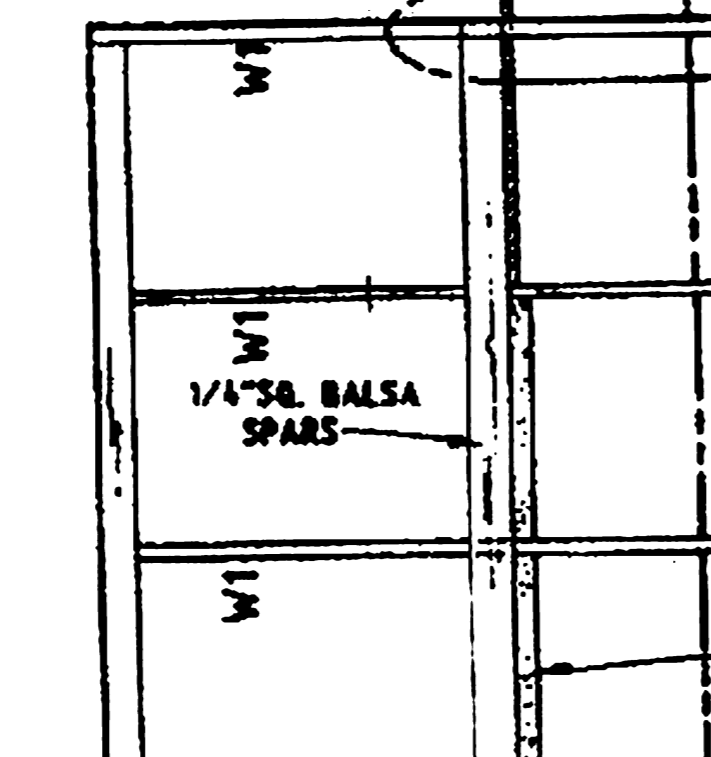
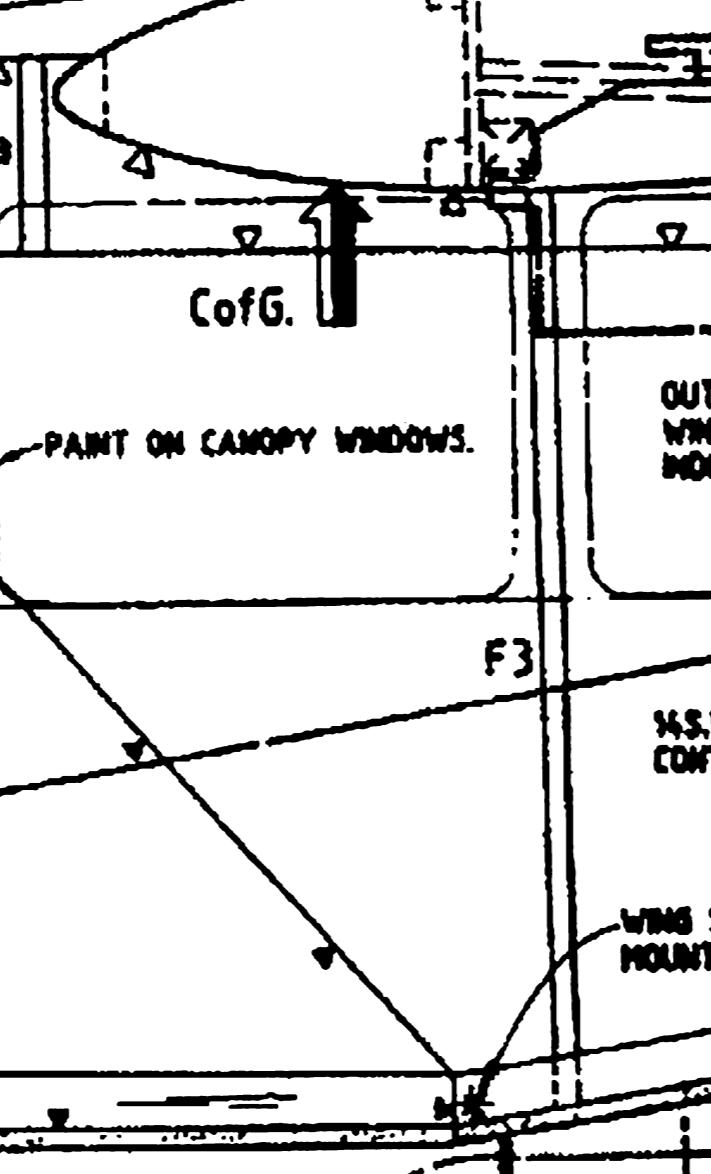

1/8" SHEET

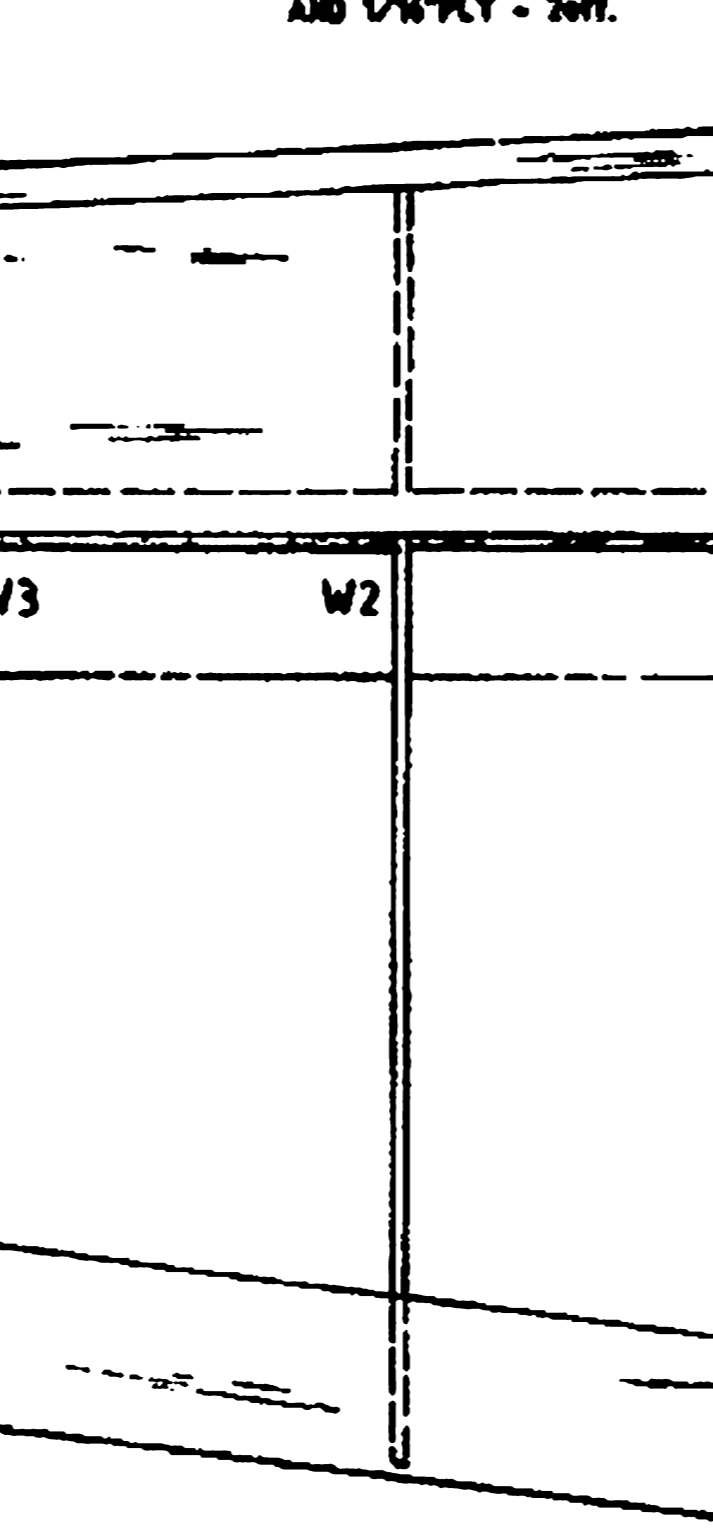
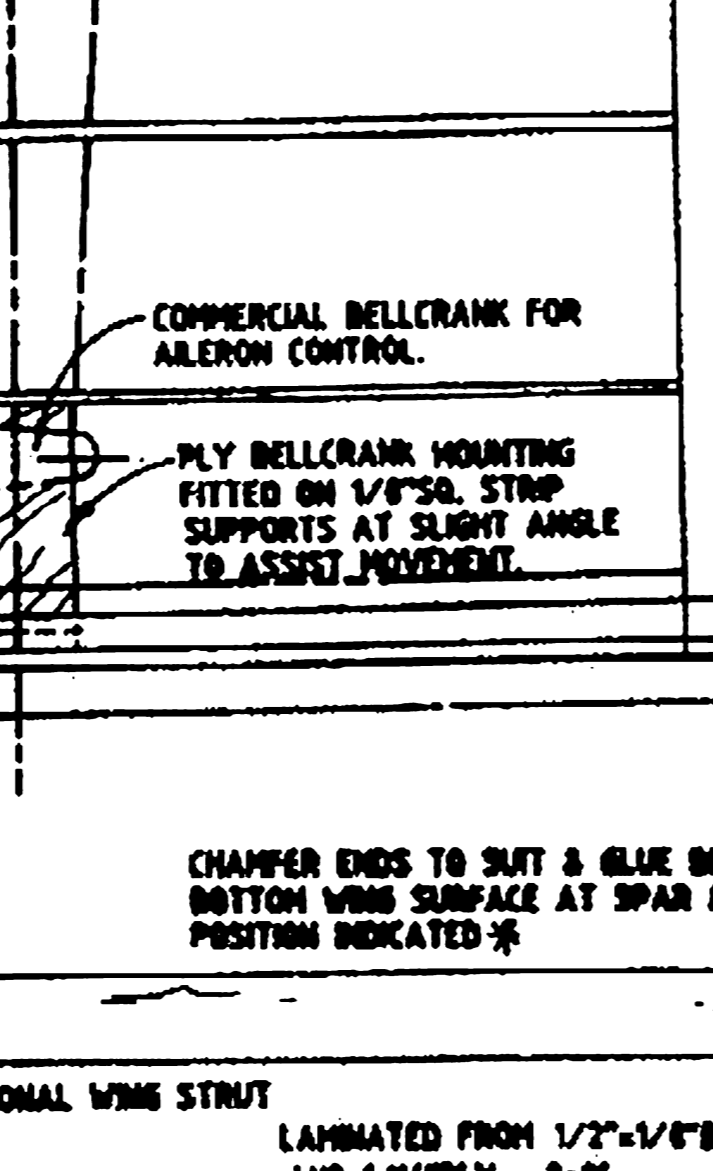
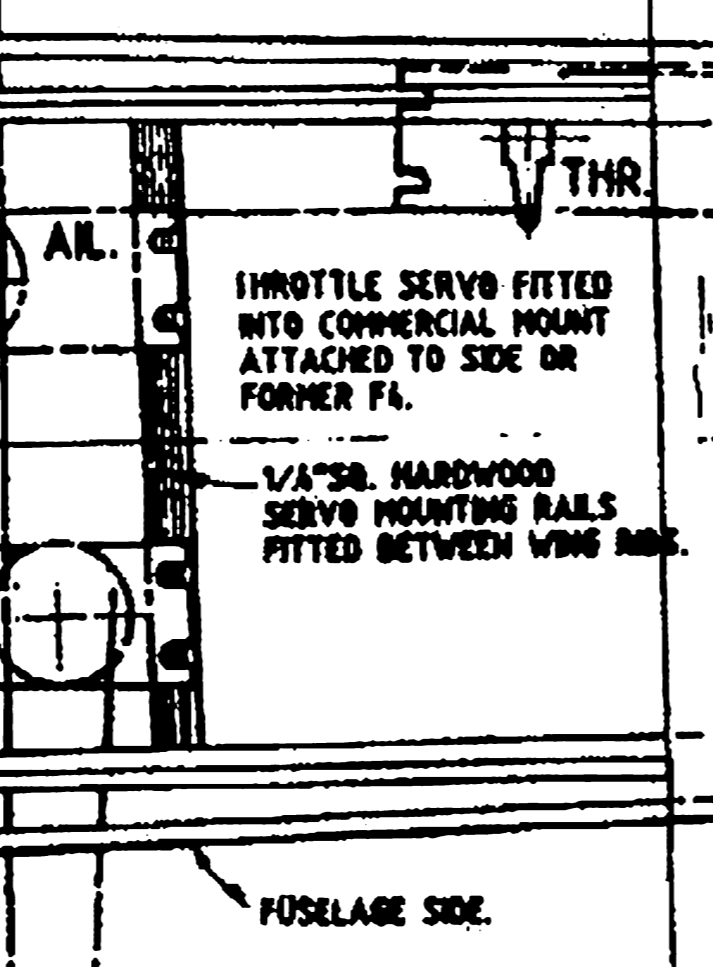
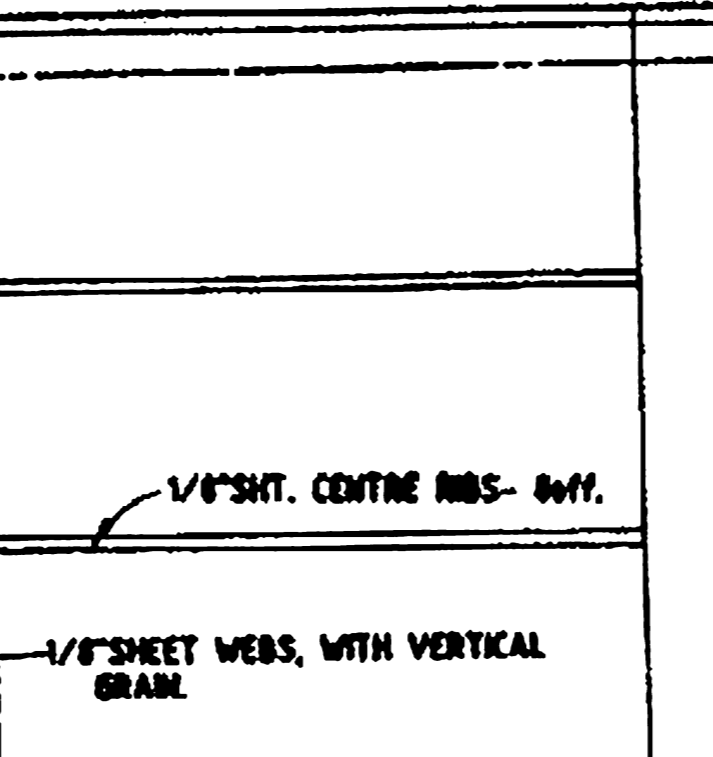
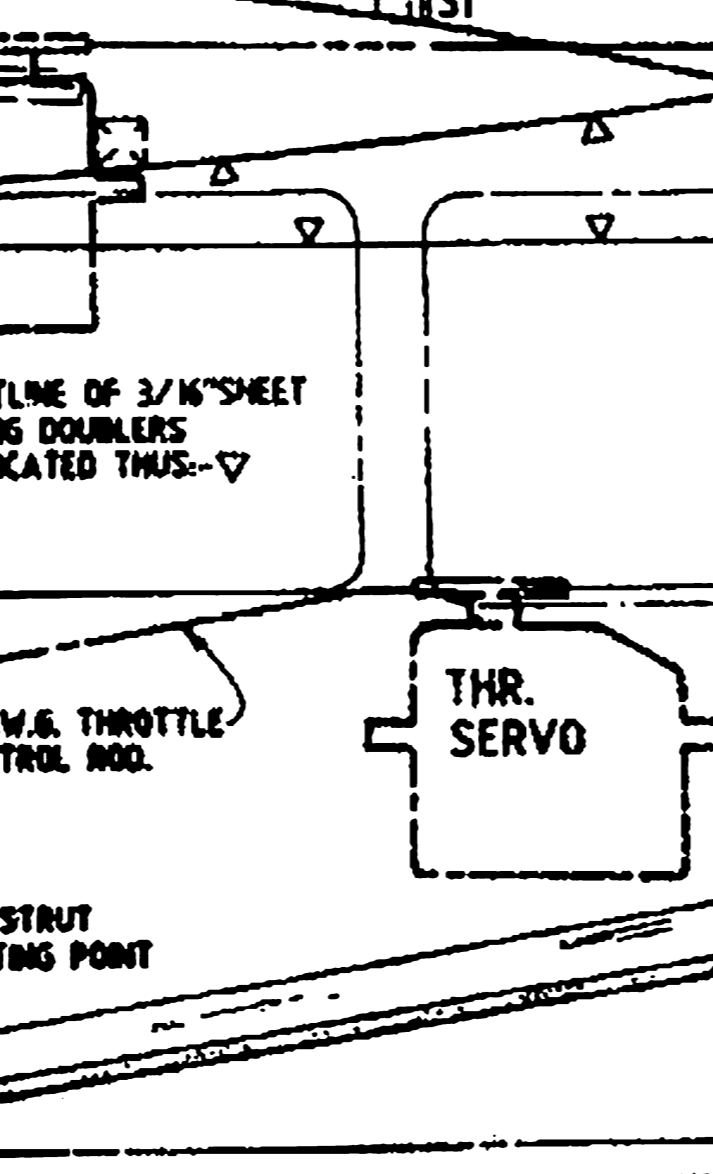

1/8" SHEET

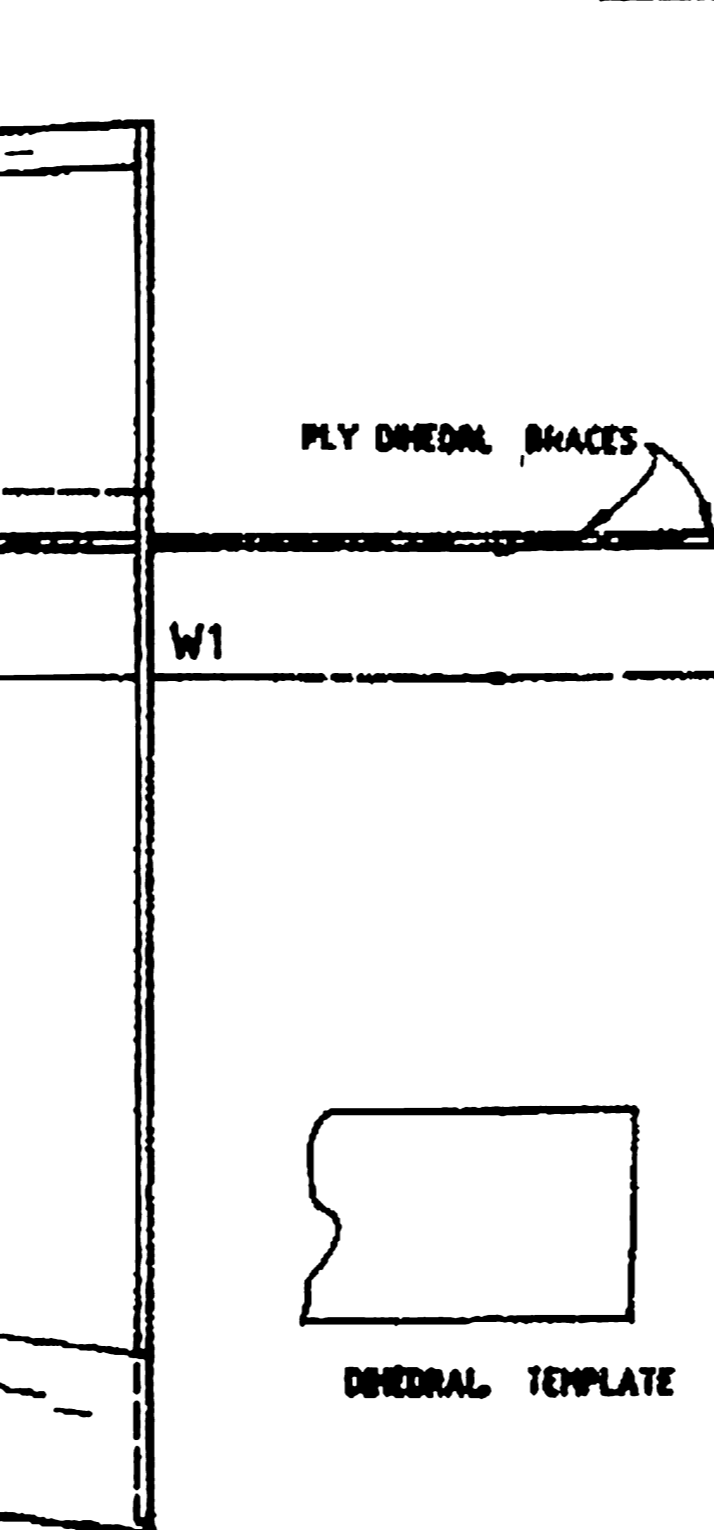
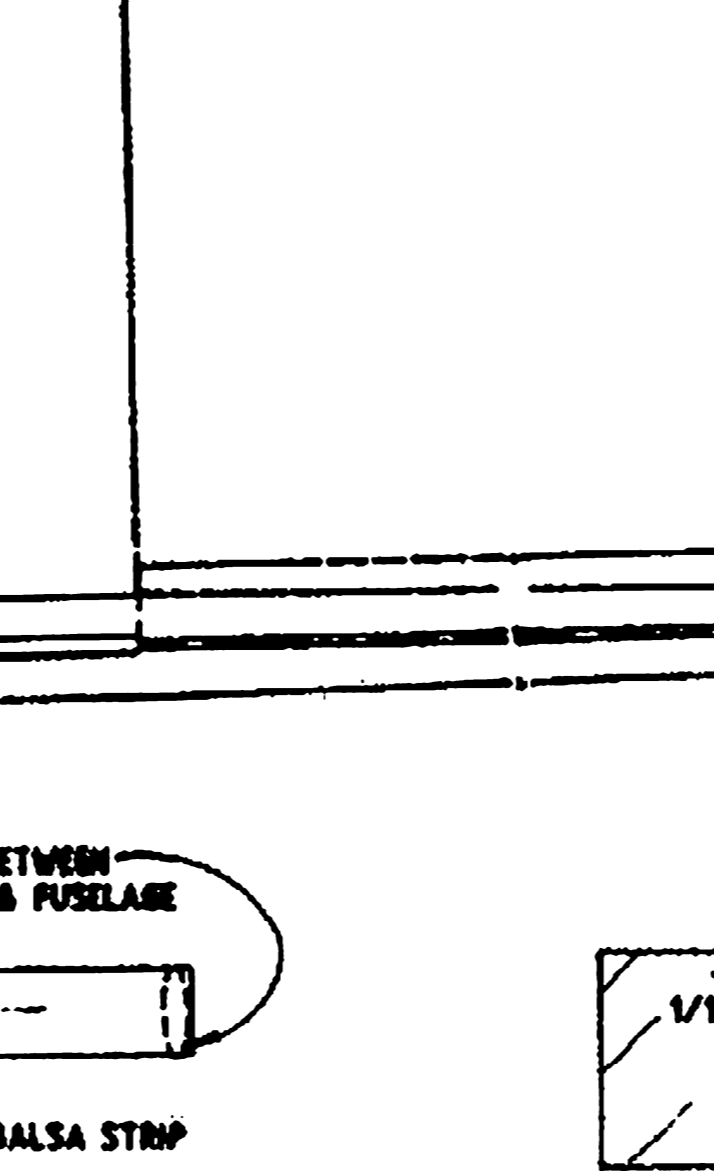
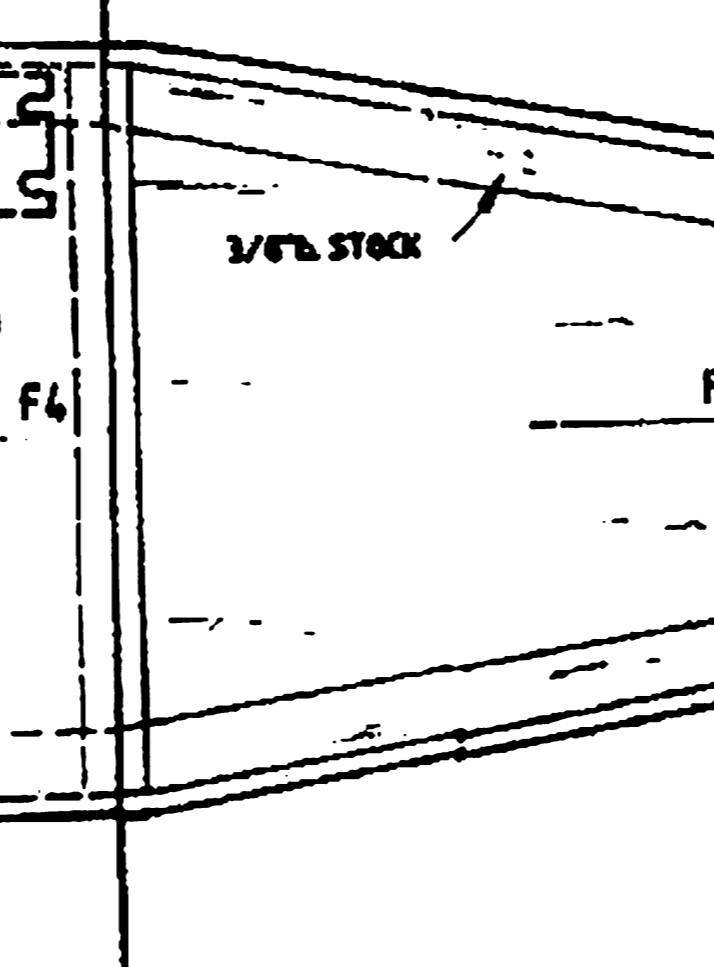
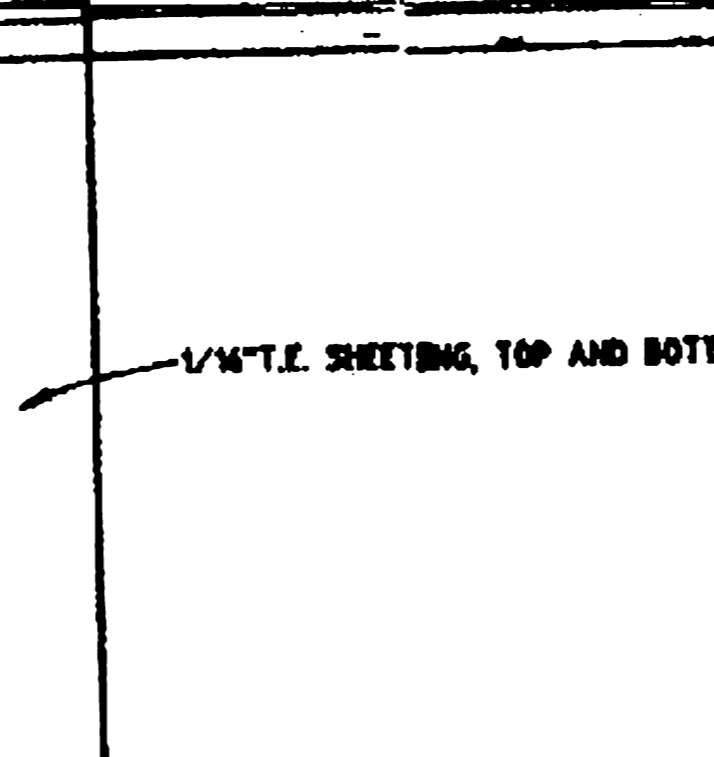
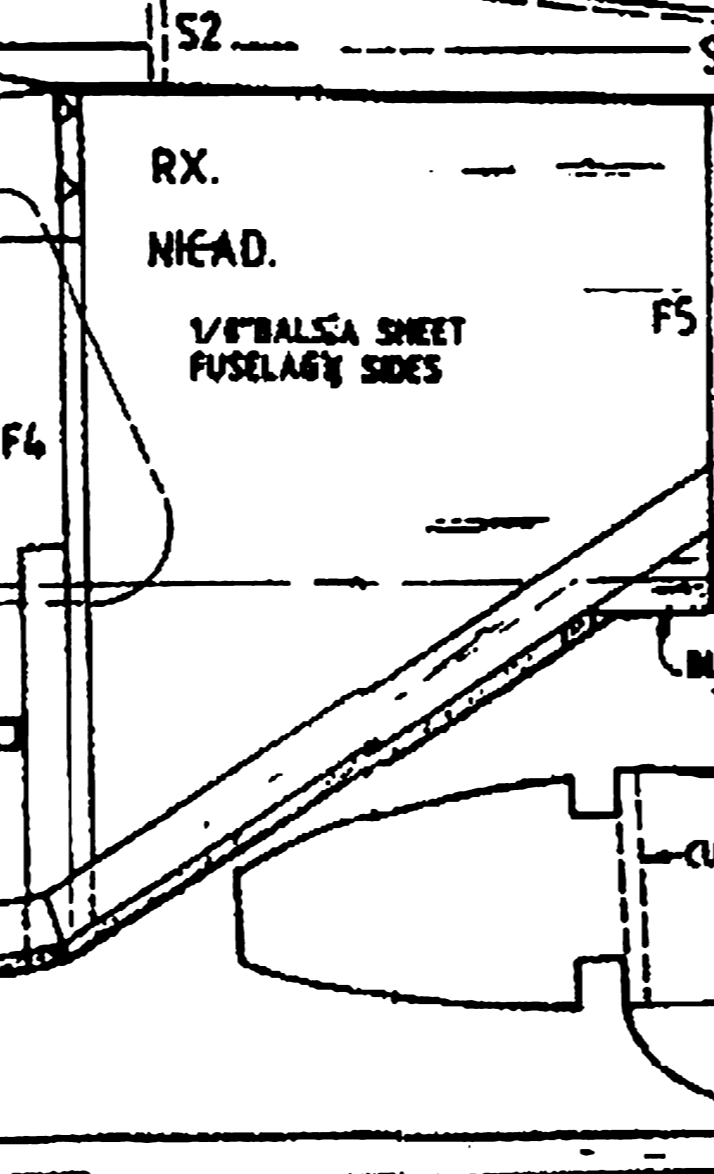

1/8" SHEET

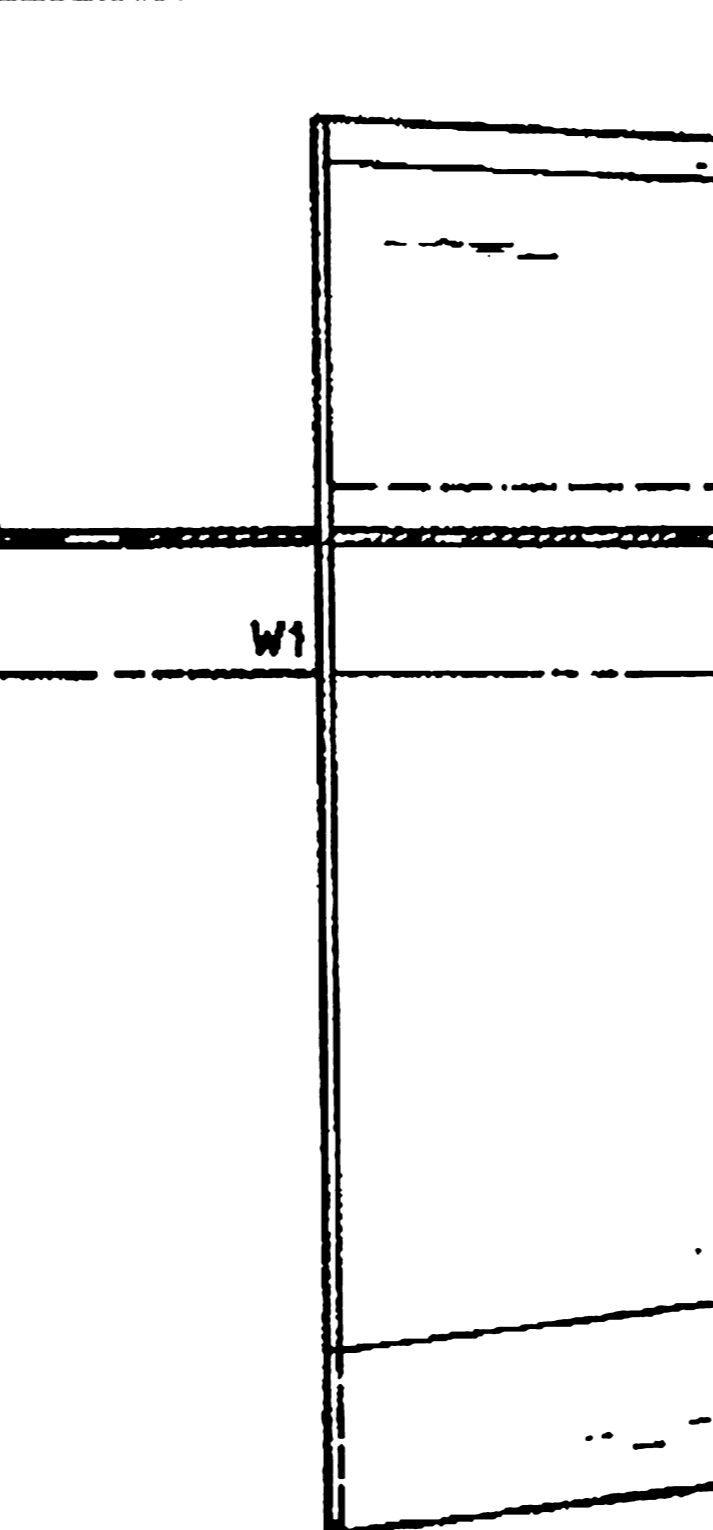
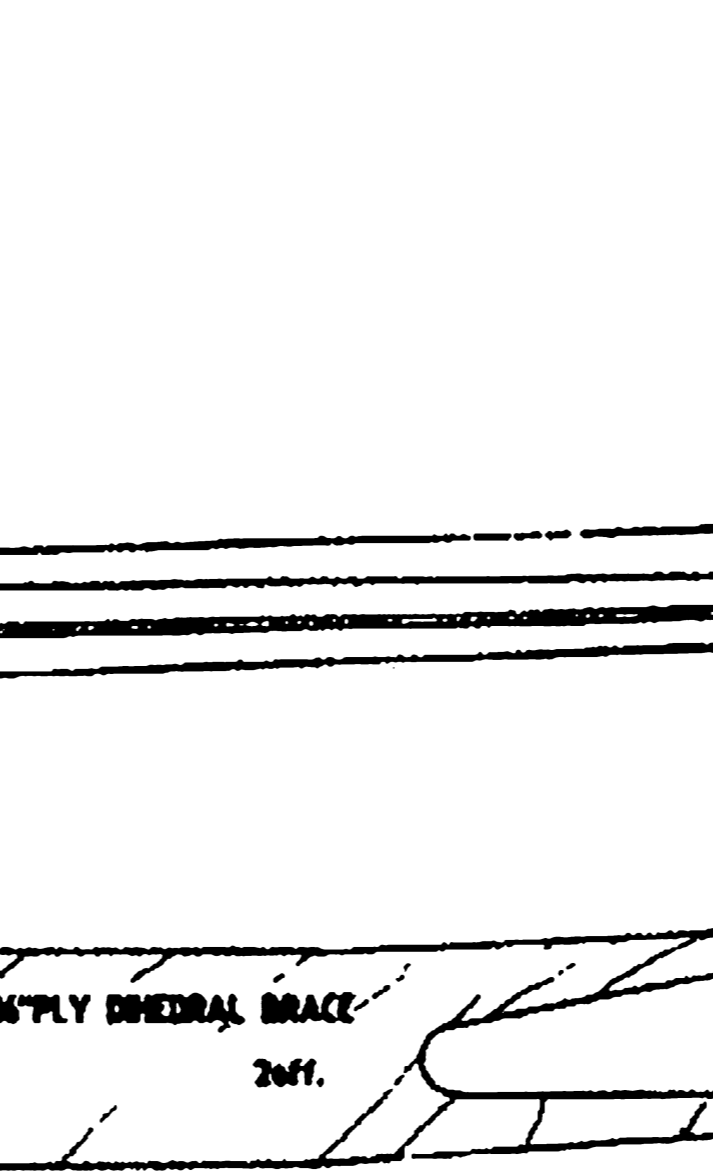
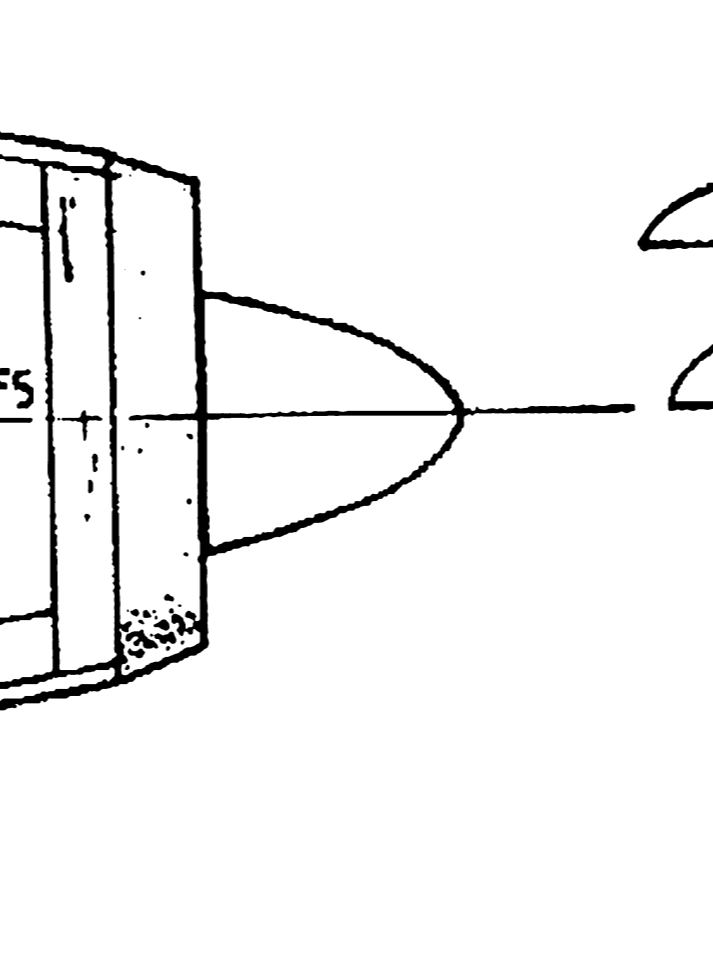
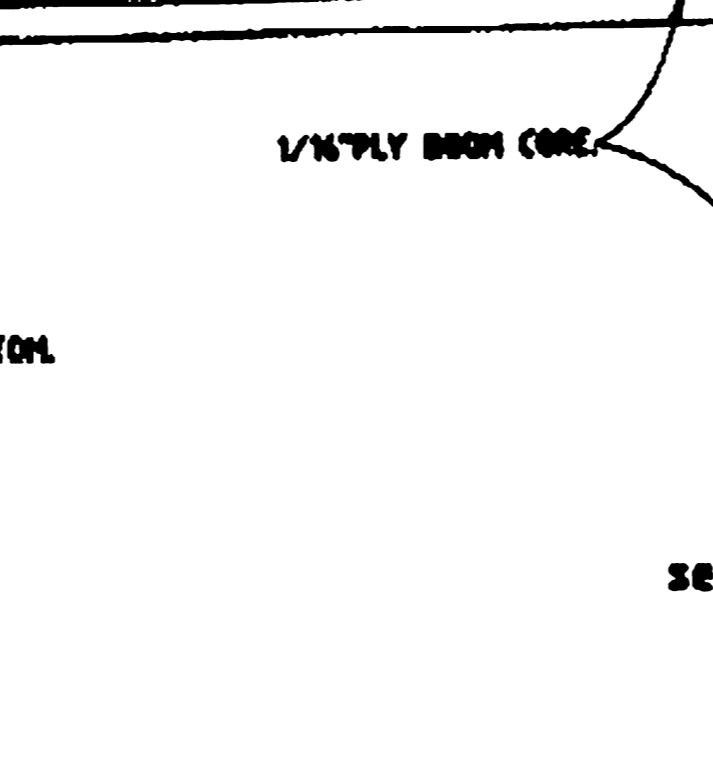
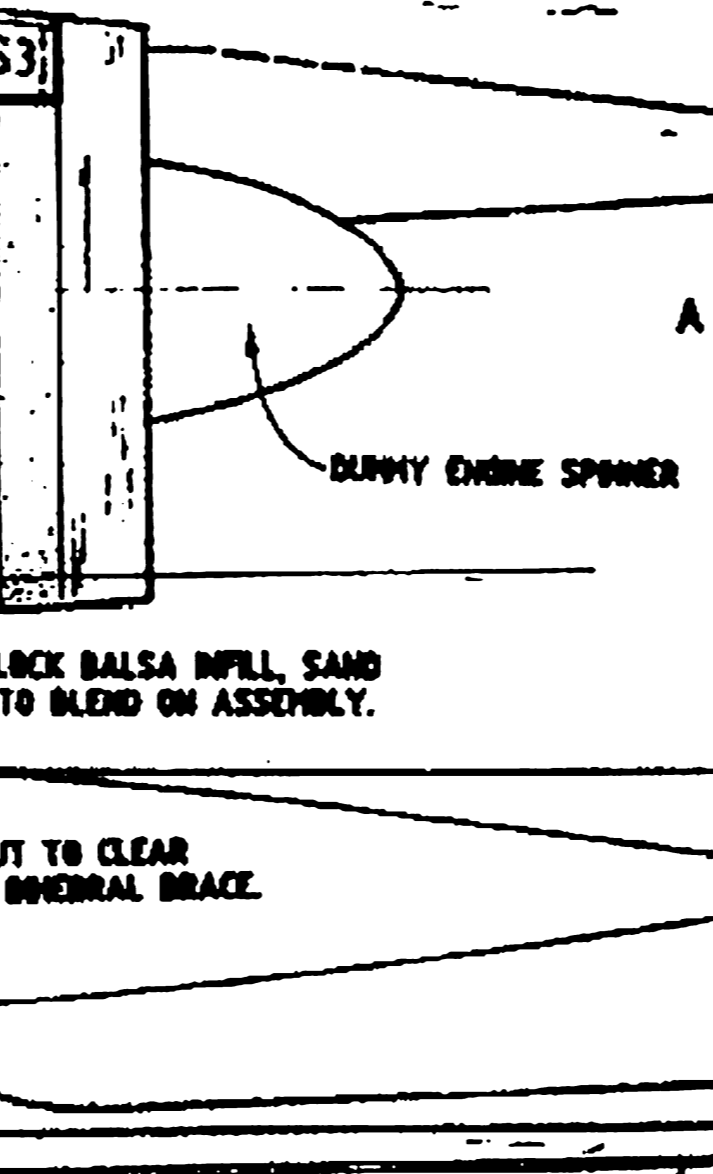

1/8" SHEET

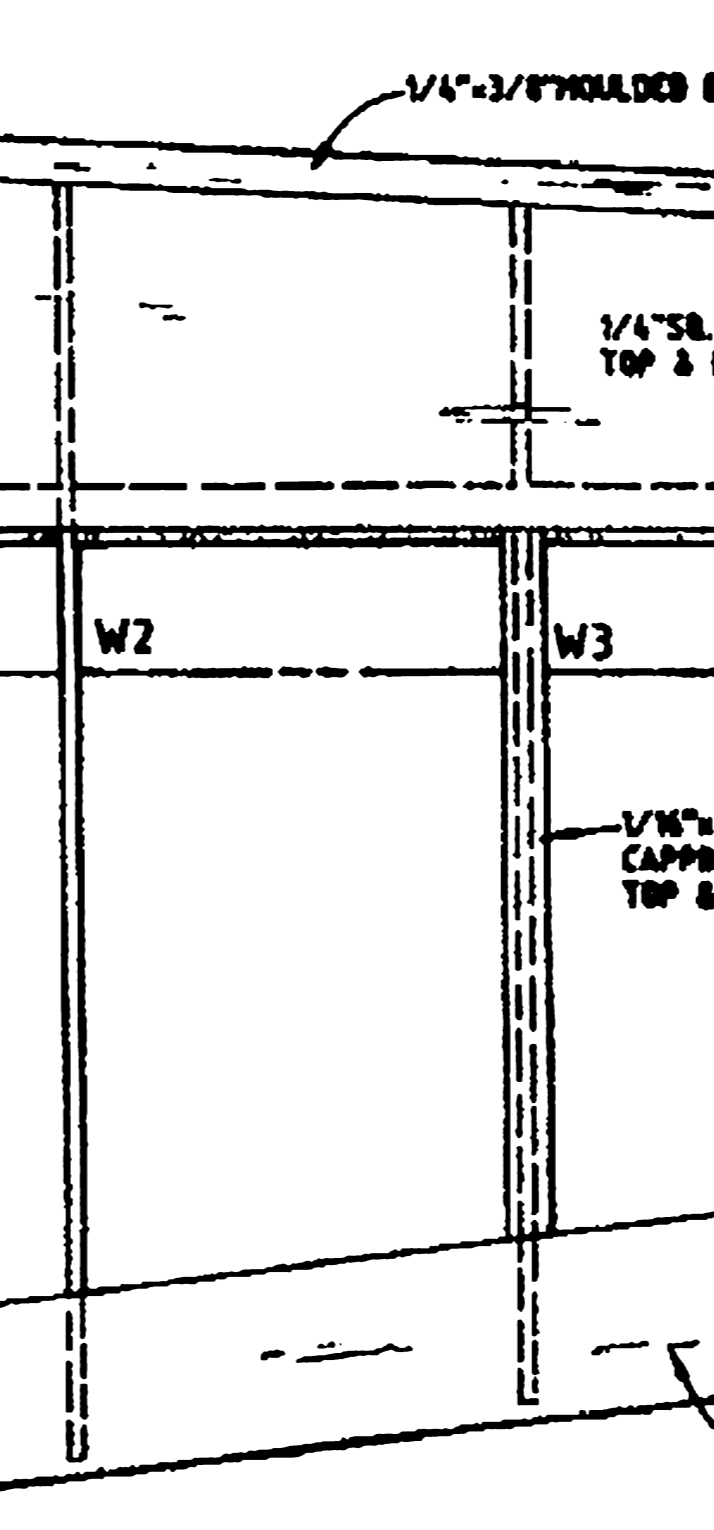
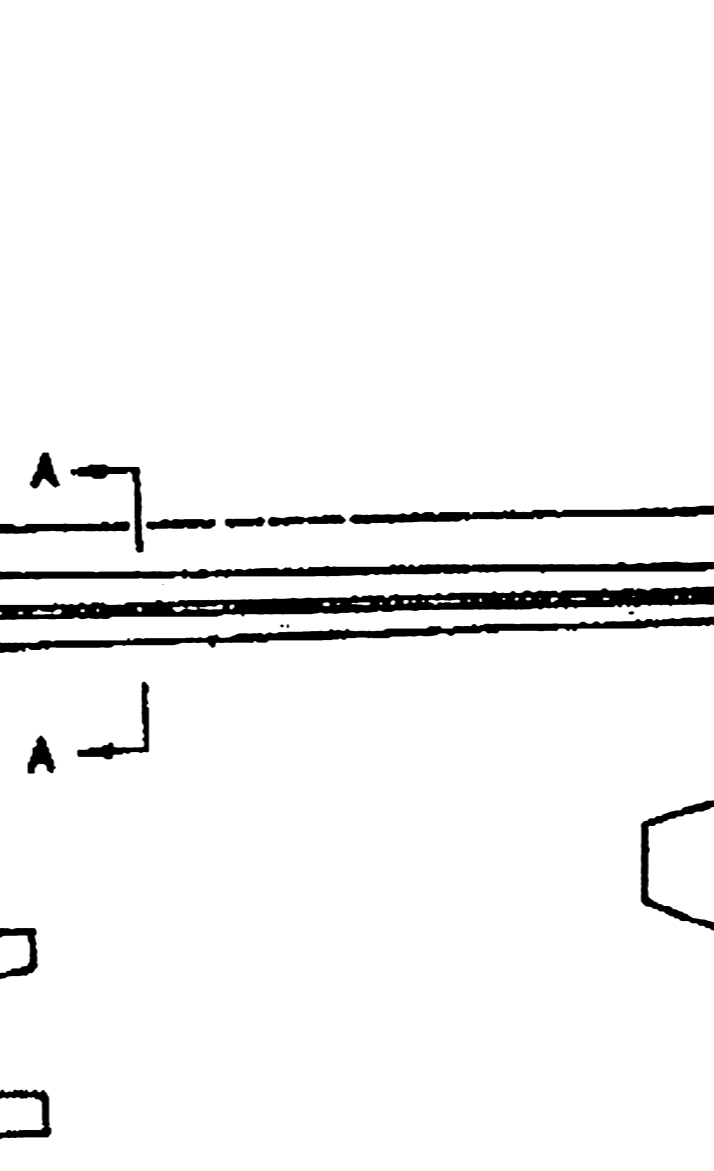
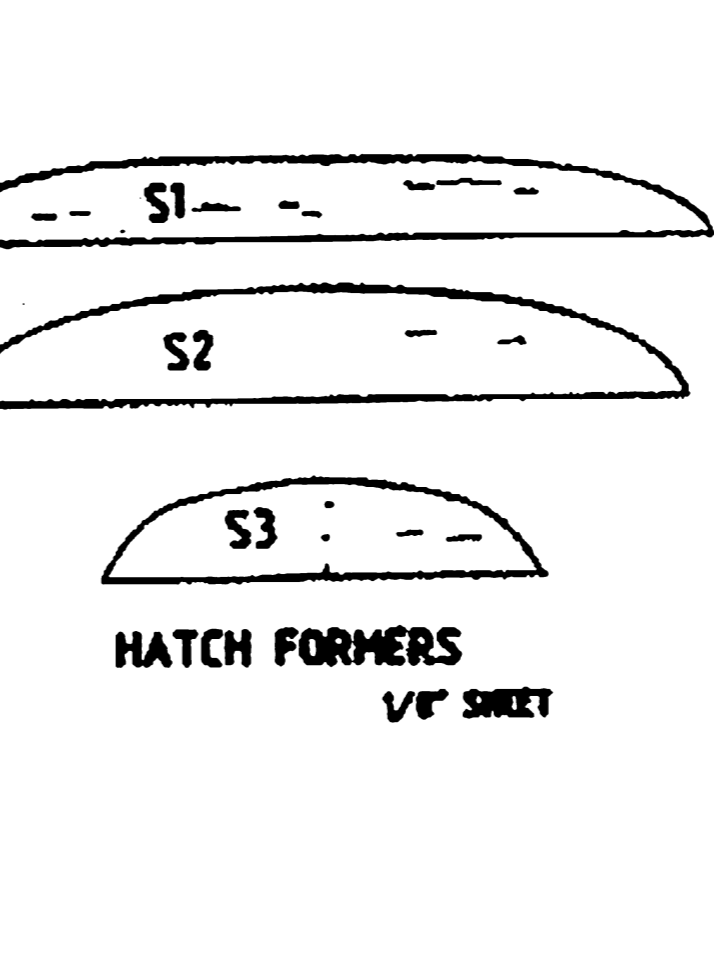
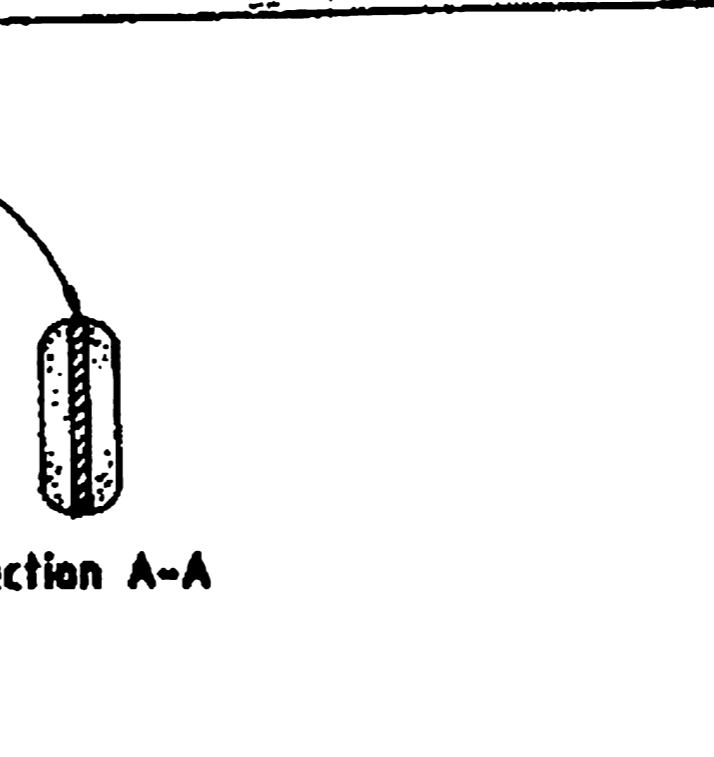
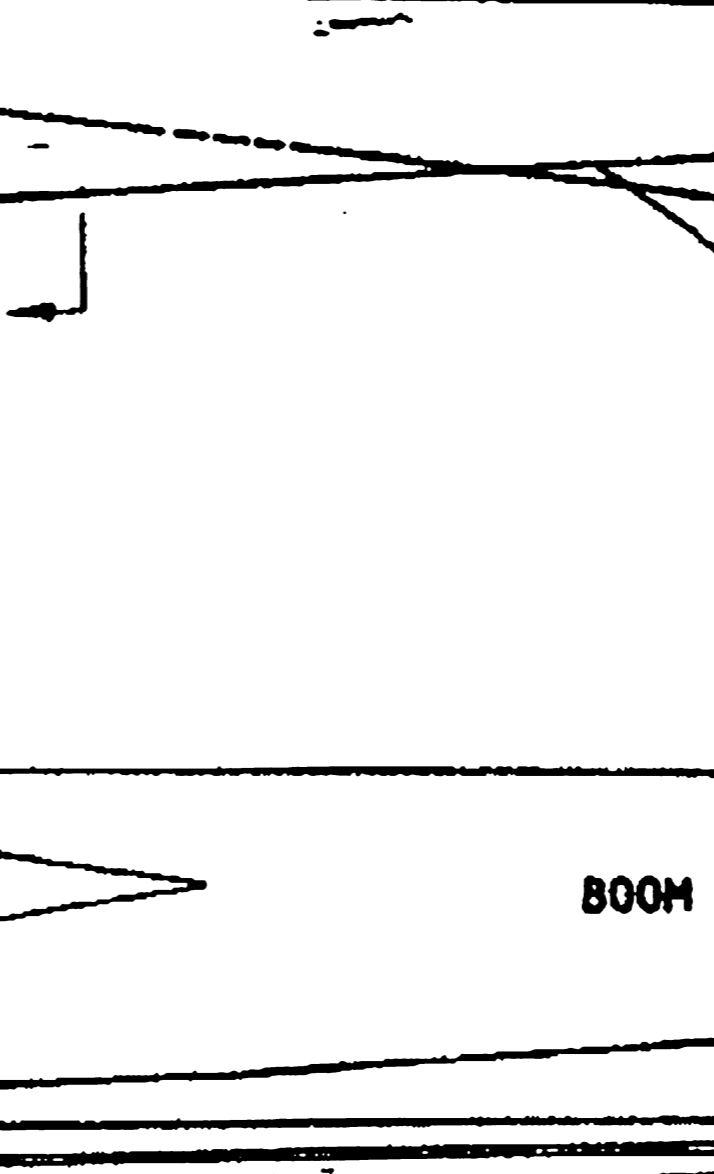

1/8" SHEET

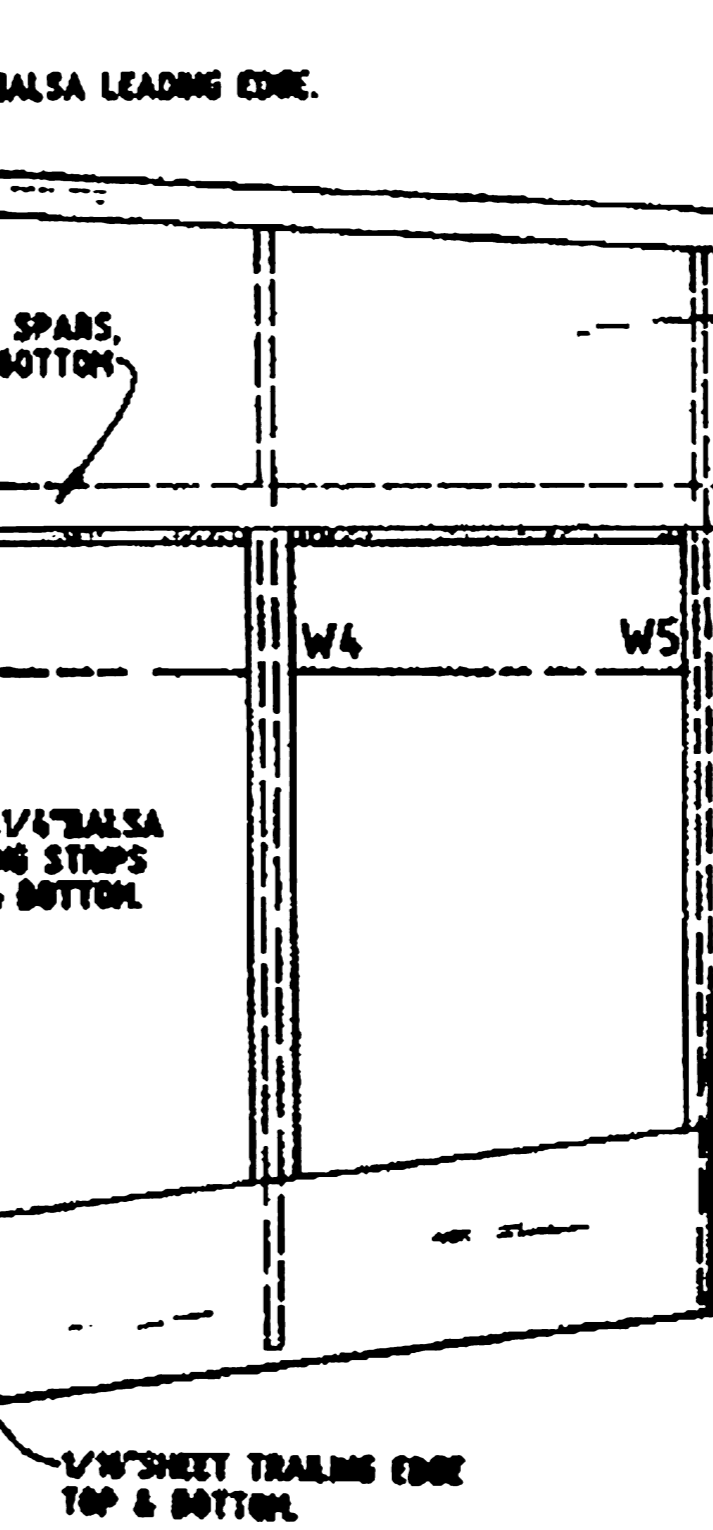
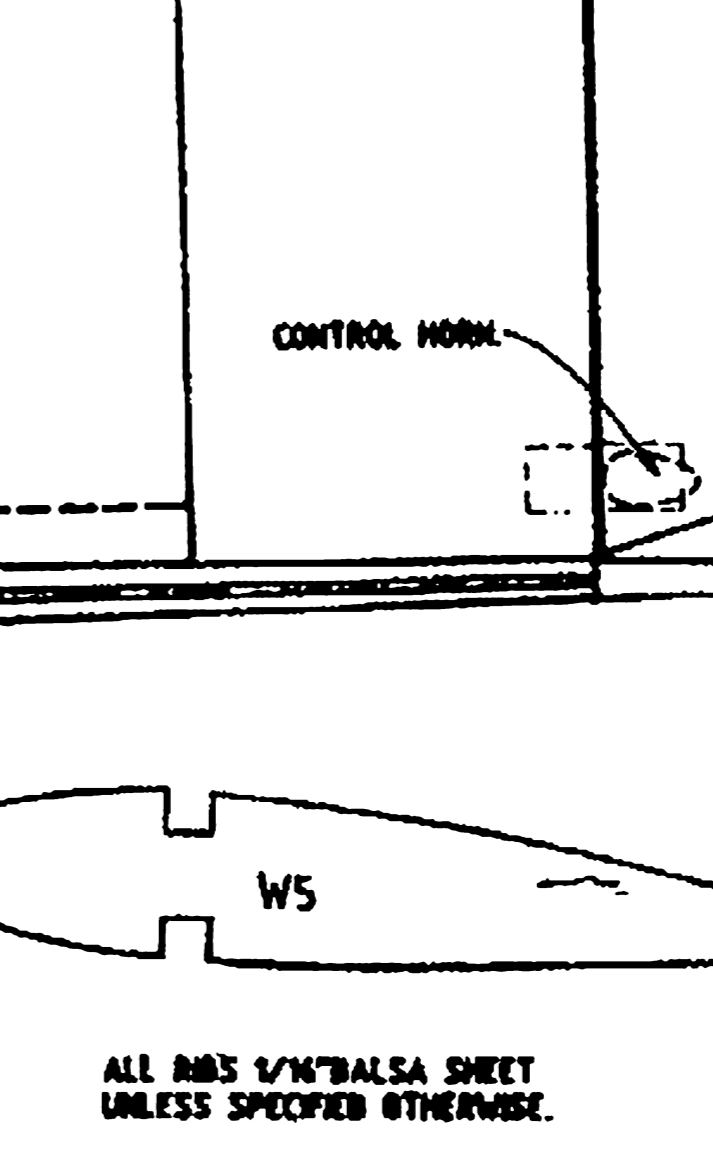
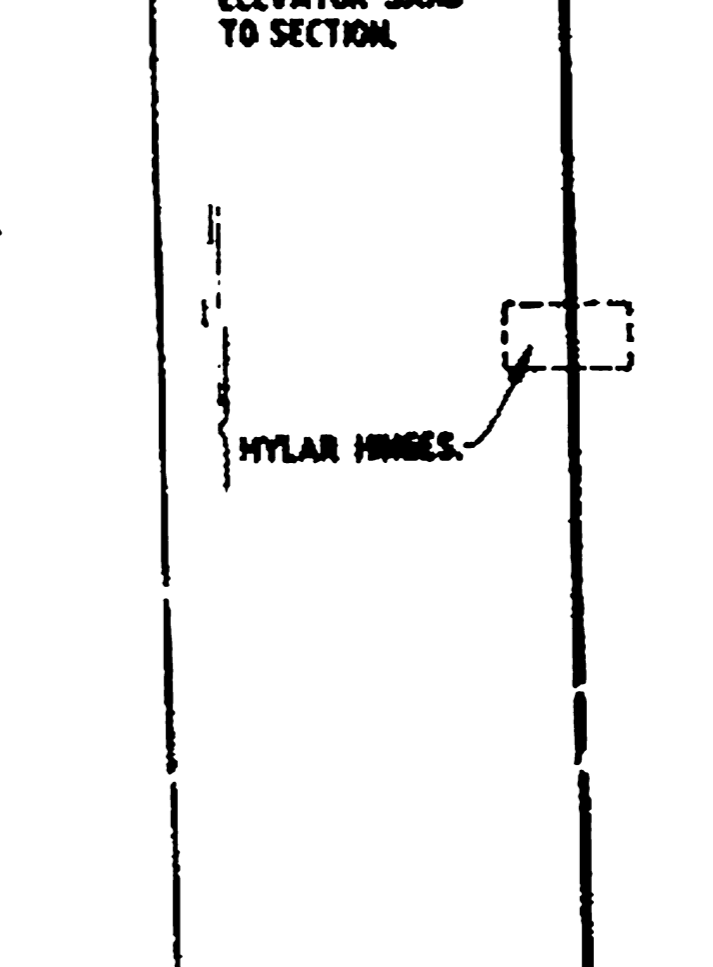
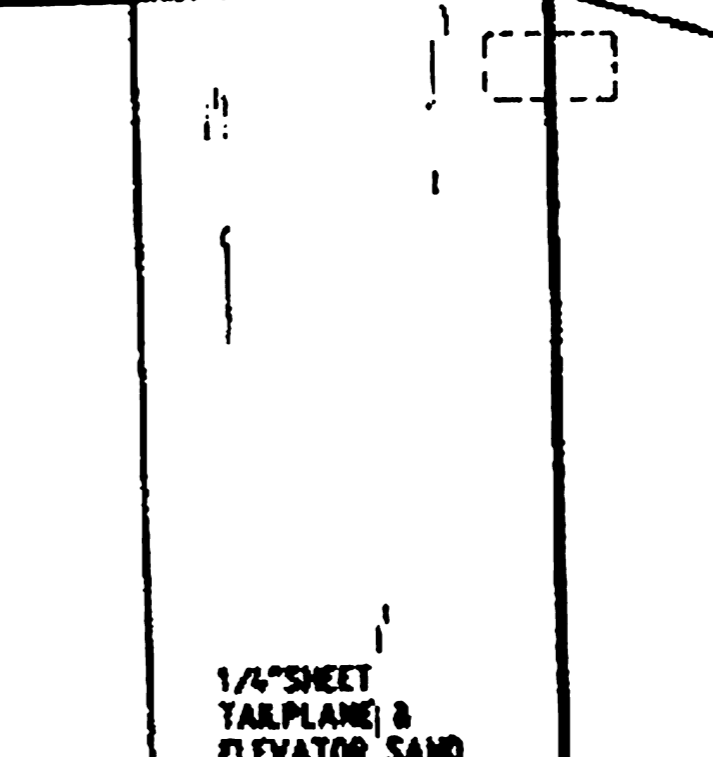
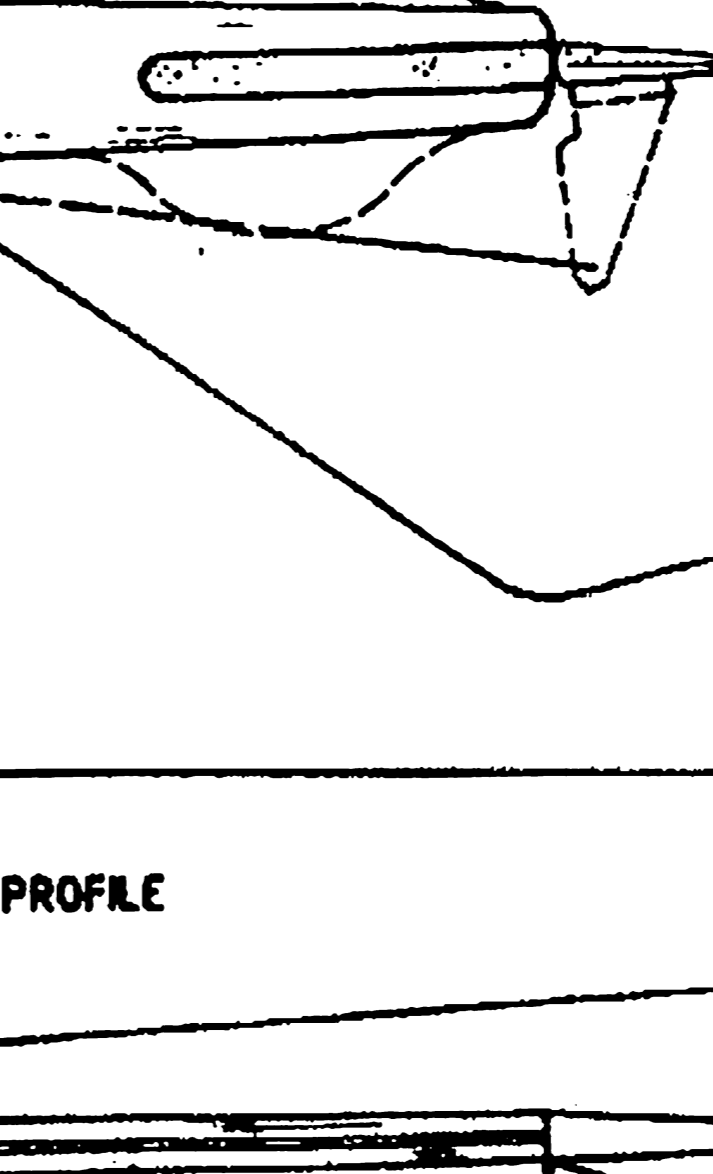

1/8" SHEET

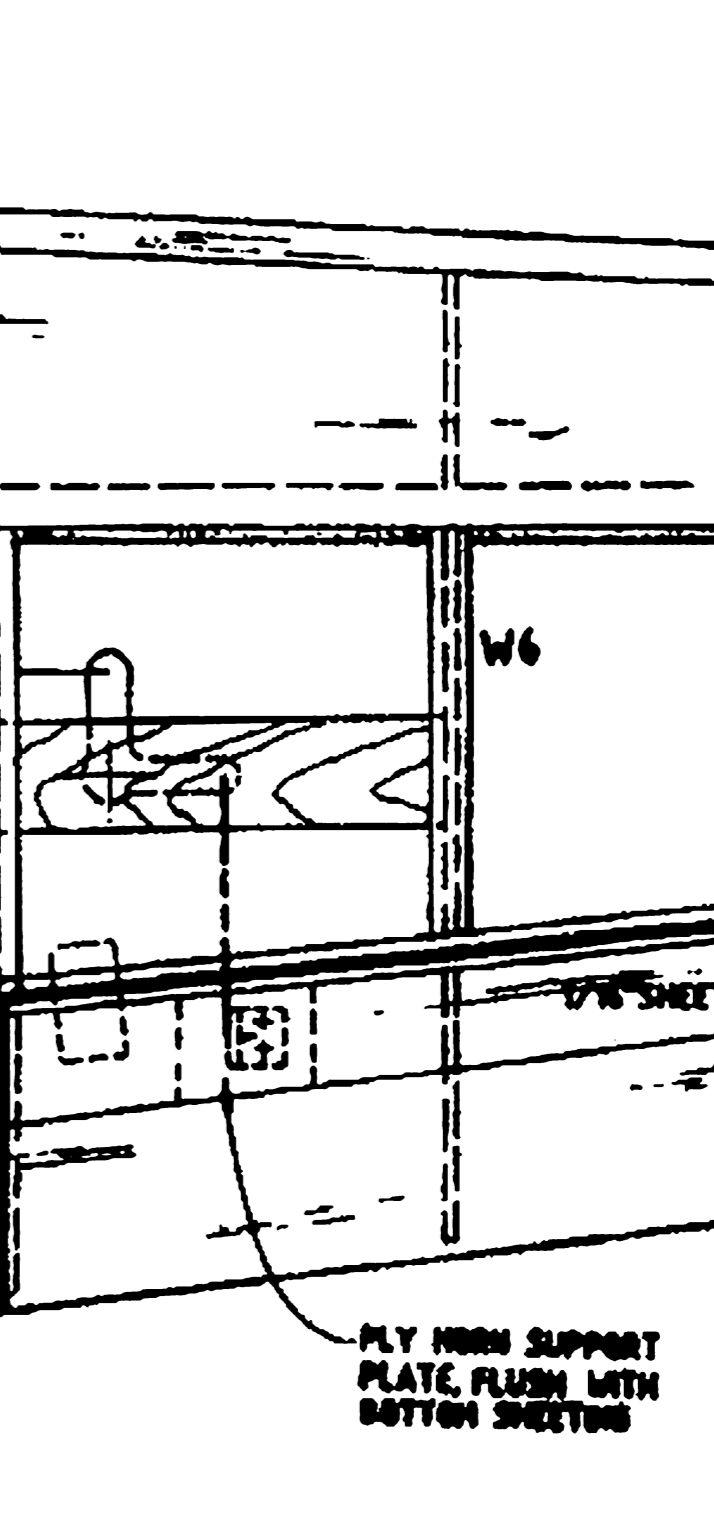
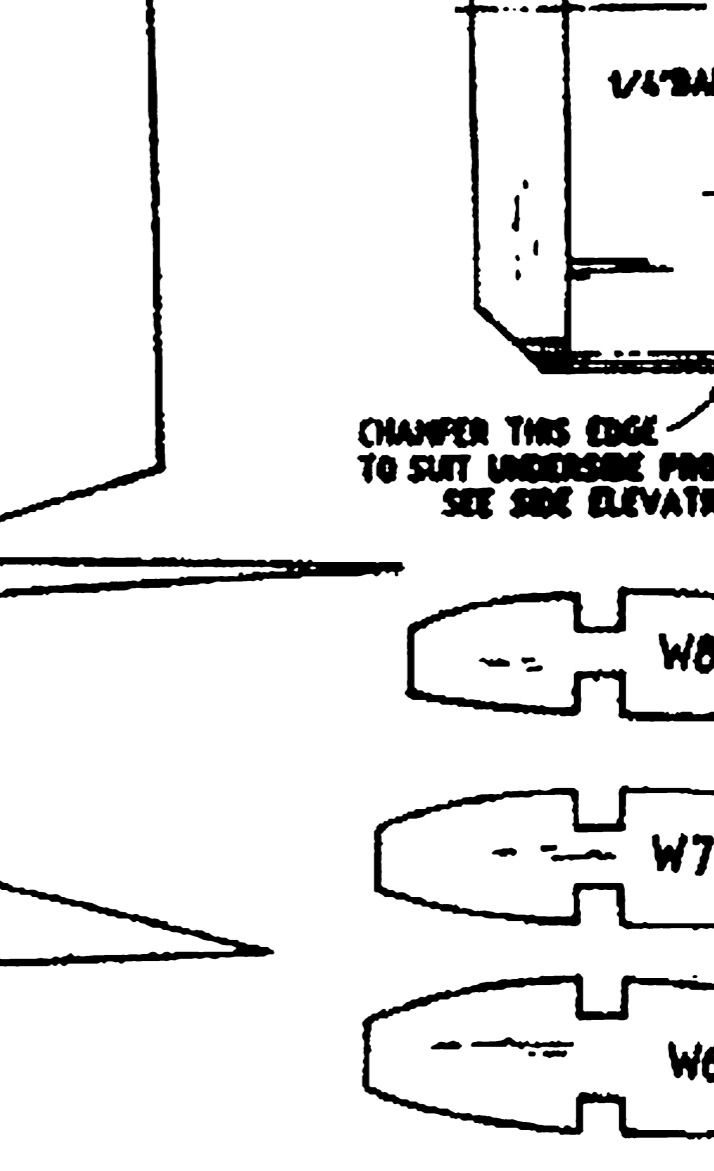
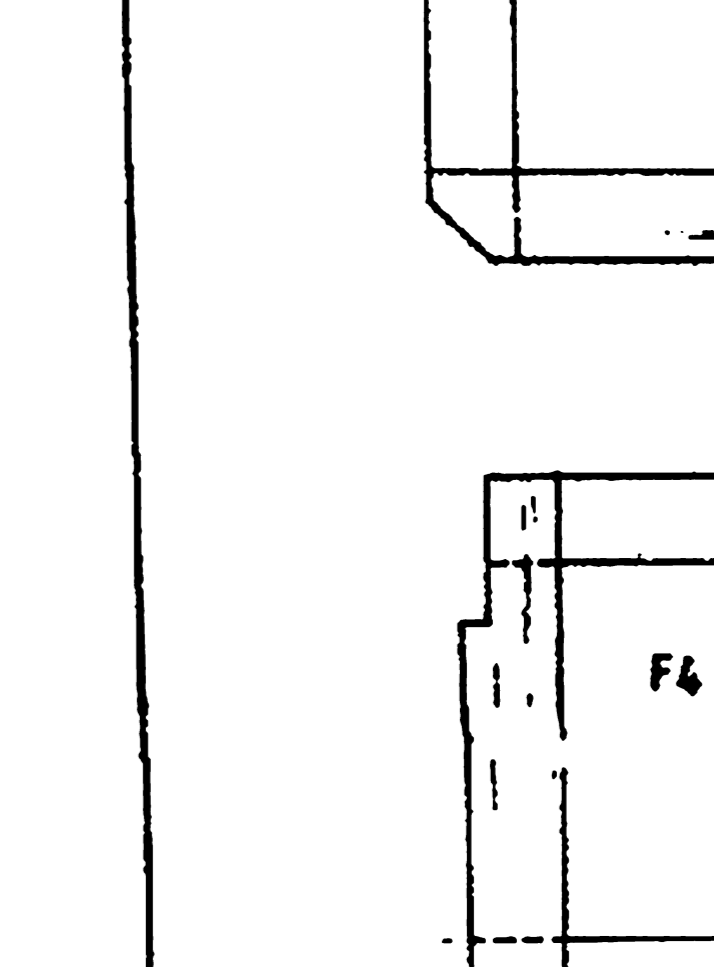
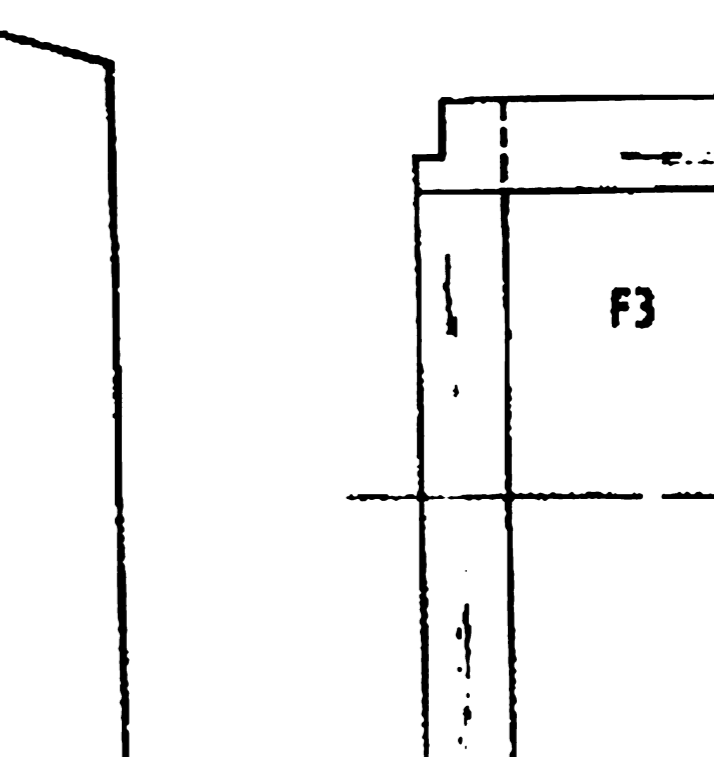
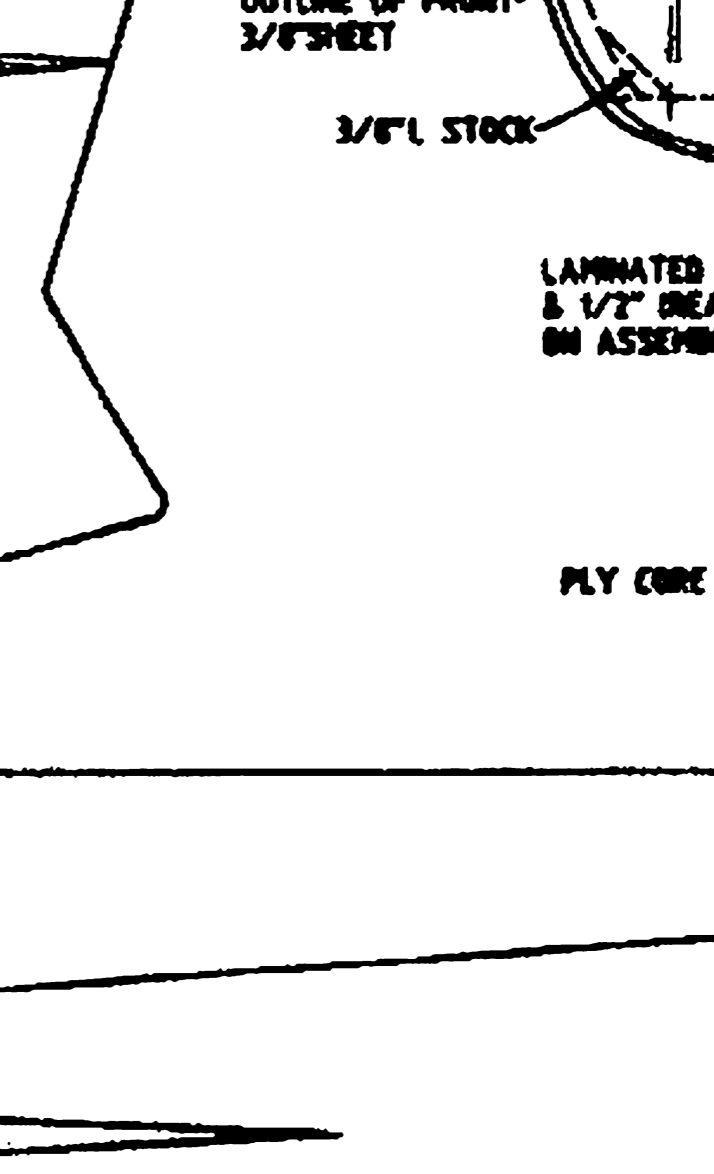

1/8" SHEET

