

# BALDOCK BIPE



designed by  
**C. Hardwick**  
copyright of

1 of 2

The R.C.M.&E. Plans Service  
13-35 Bridge Street, Hemel Hempstead, Herts.

Make paper template of  
Windshield and trim to suit.

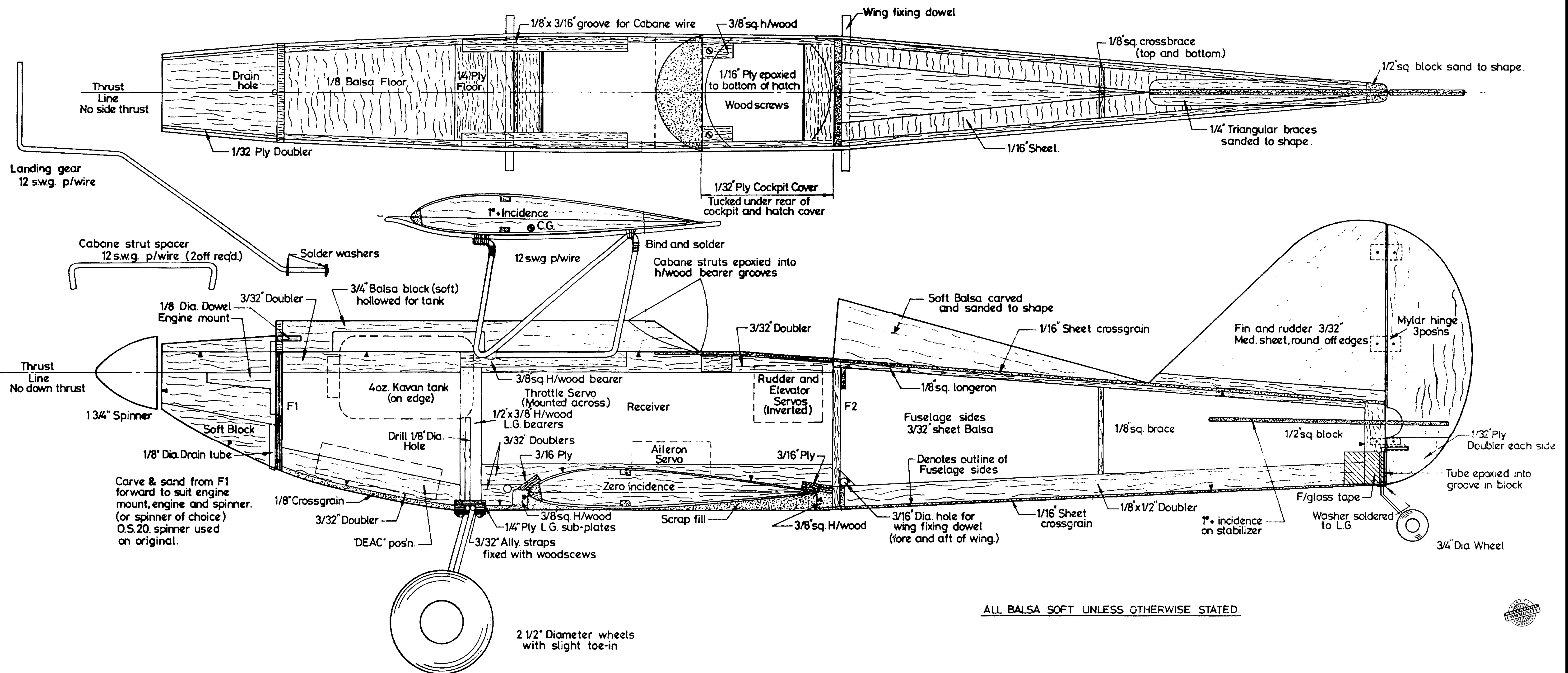
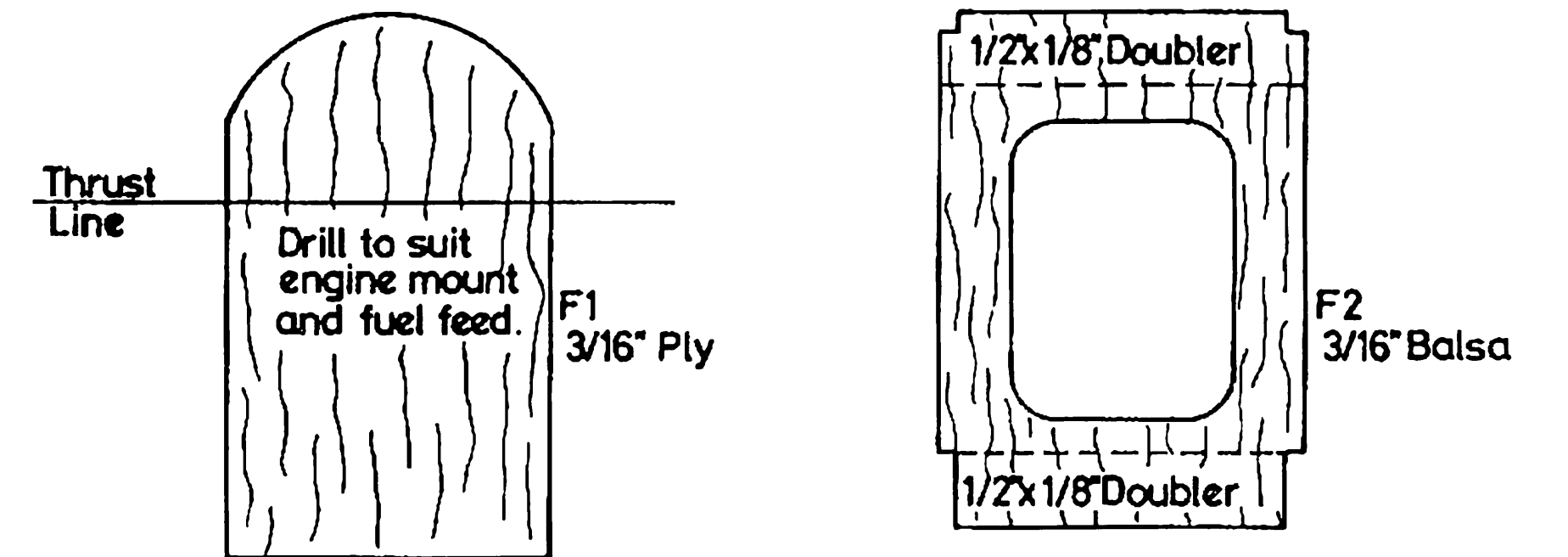
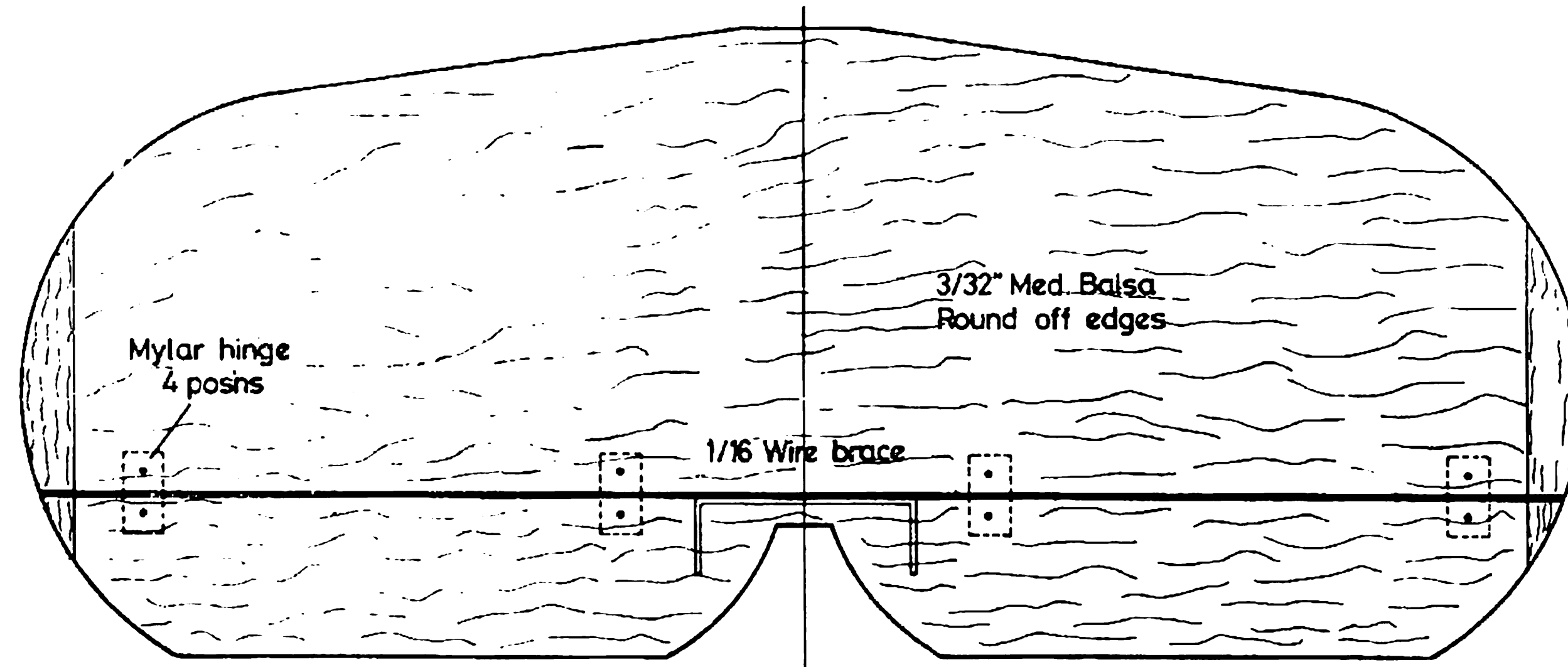
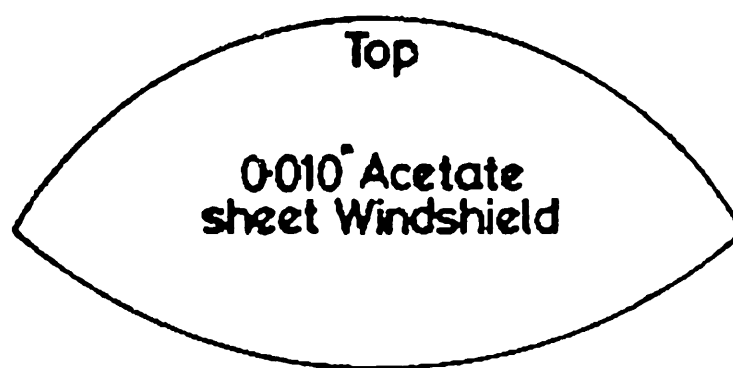

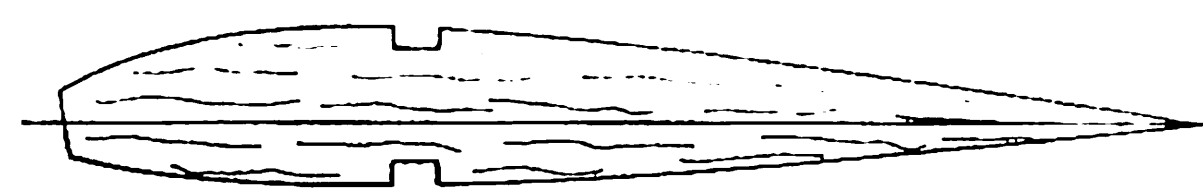

Wing ribs-10 off W1 1/8" Balsa  
 20 off W2 1/16" Balsa

**TOP WING**

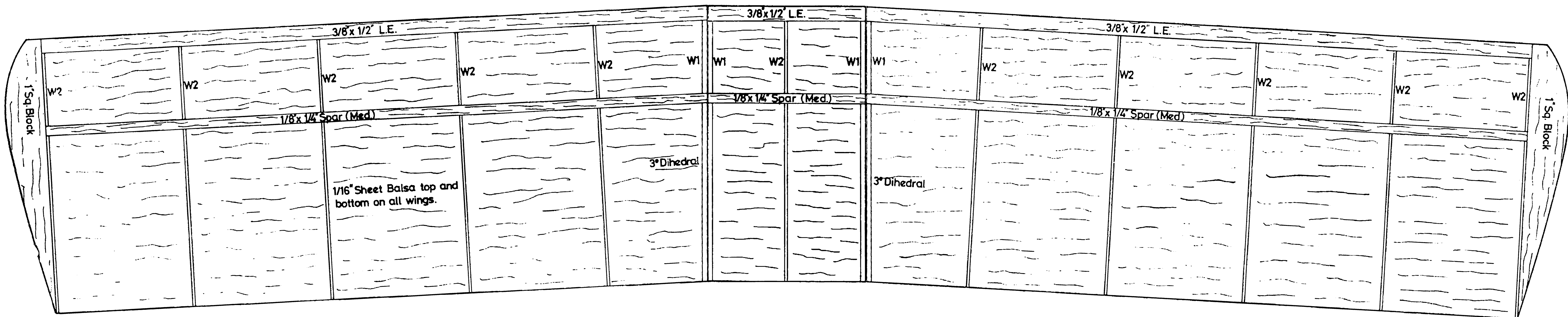

**LOWER WING**

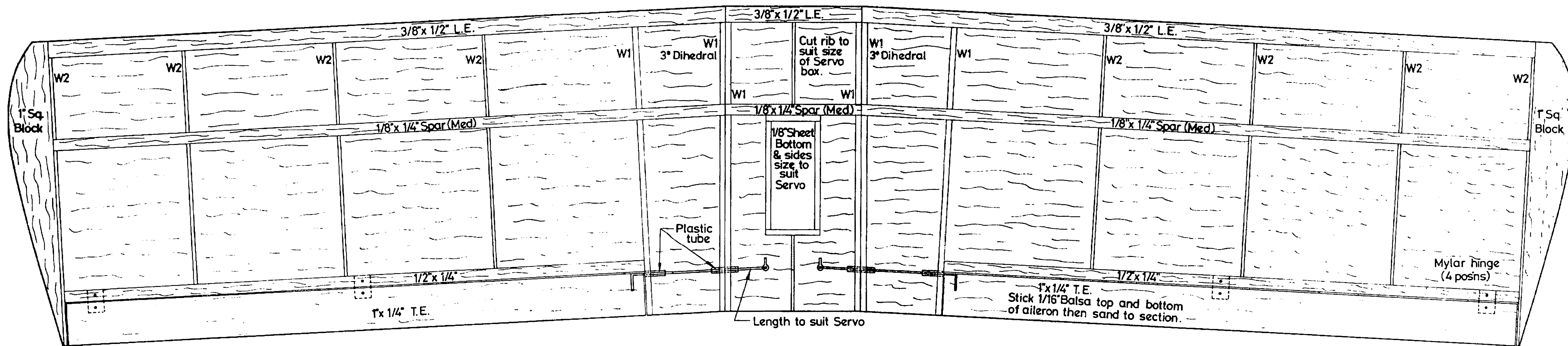

1" F/glass bandage on all wing joints.

