

全長	LENGTH	全長	1440 mm	56 2/3"
全幅	WING SPAN	全幅	1770 mm	69 3/4"
主翼面積	WING AREA	主翼面積	54.5 dm ²	84.4 sq. in.
全機重量	WEIGHT	全機重量	3.8-4.0 kg	8.4-8.8 lb.
エンジン	ENGINE	エンジン	120-4C	20 ccm.
RCメカ	RC SYSTEM	RCメカ	5-7ch.	
設計	DESIGNED	設計	ENTWURF	M. KATO

ZLIN

Z-540L

KATO MODEL AIRCRAFT CO. LTD. OSAKA JAPAN

PRINTED IN JAPAN

SHEET 1 OF 2

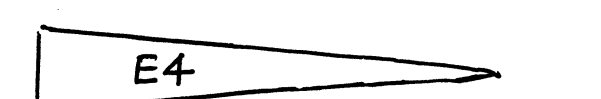
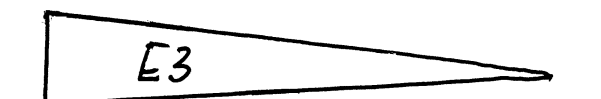
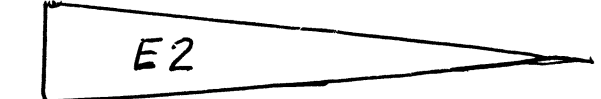
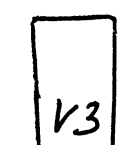
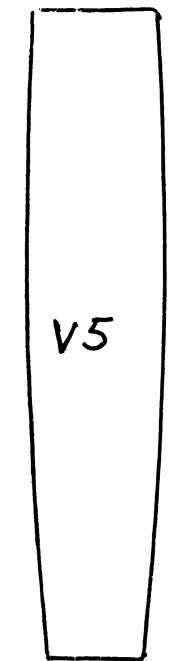
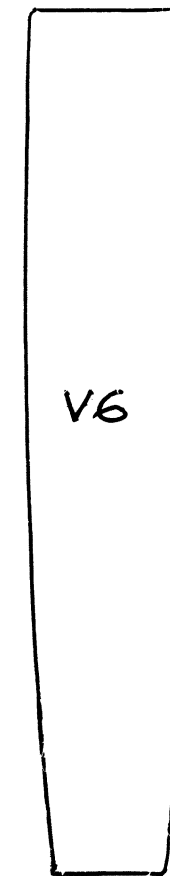
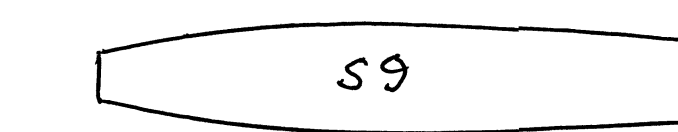
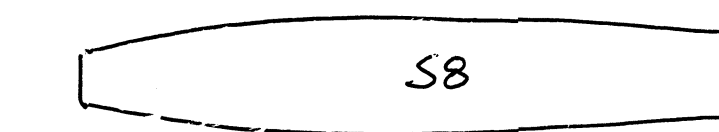
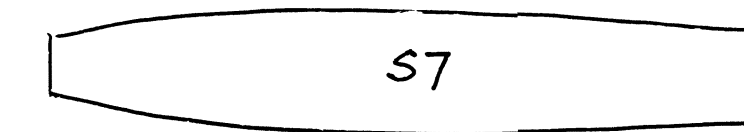
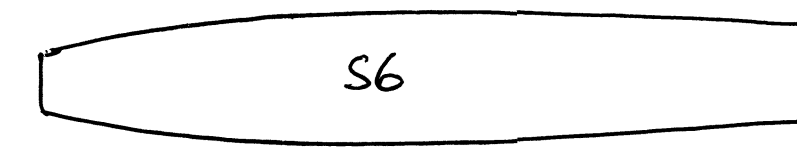
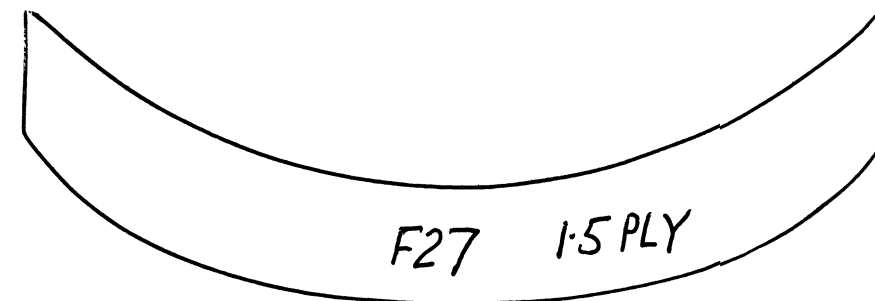
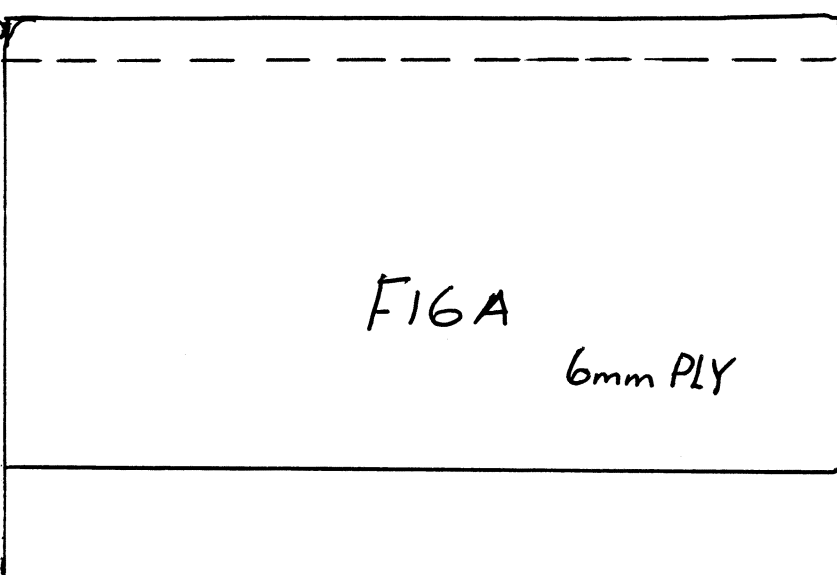
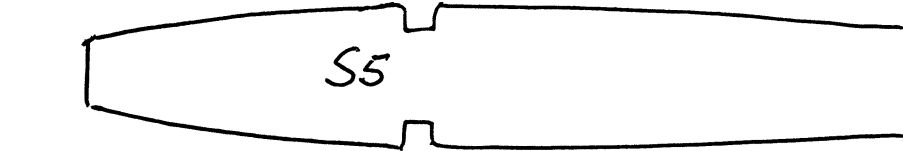
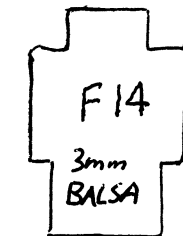
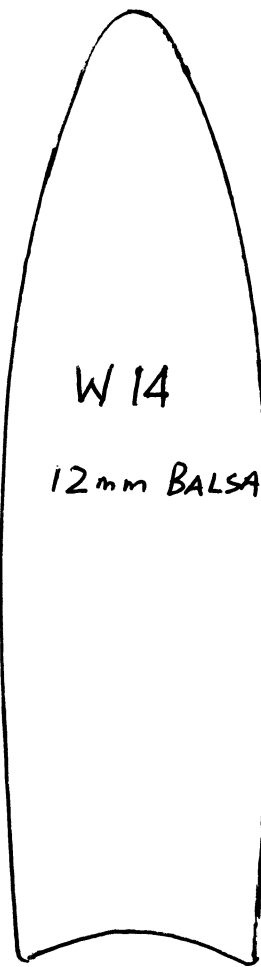
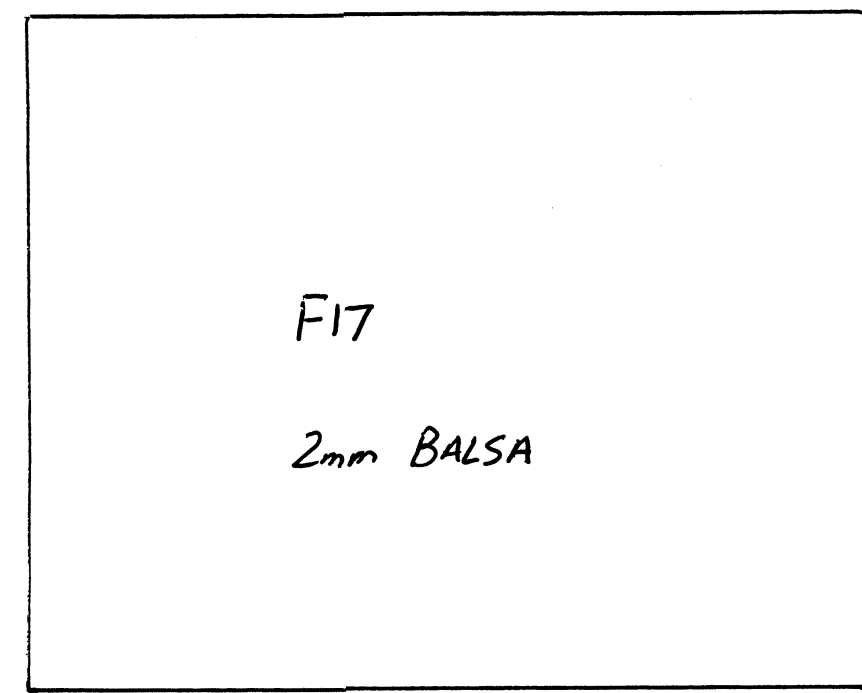
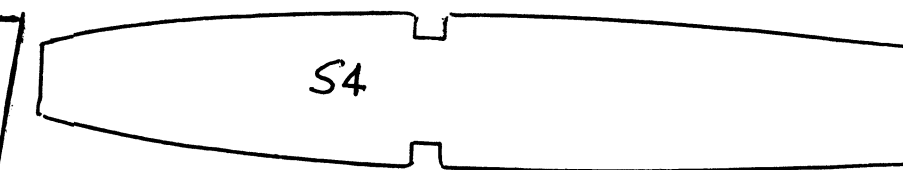
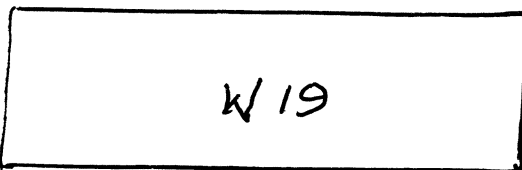
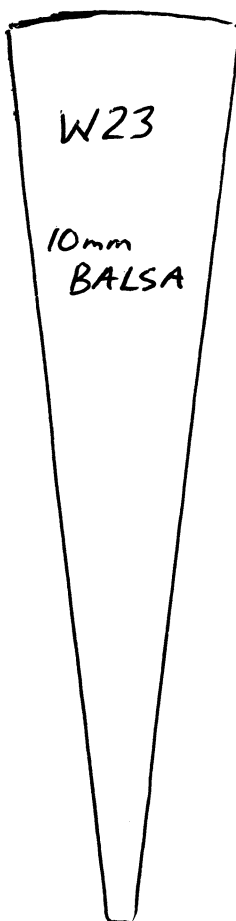
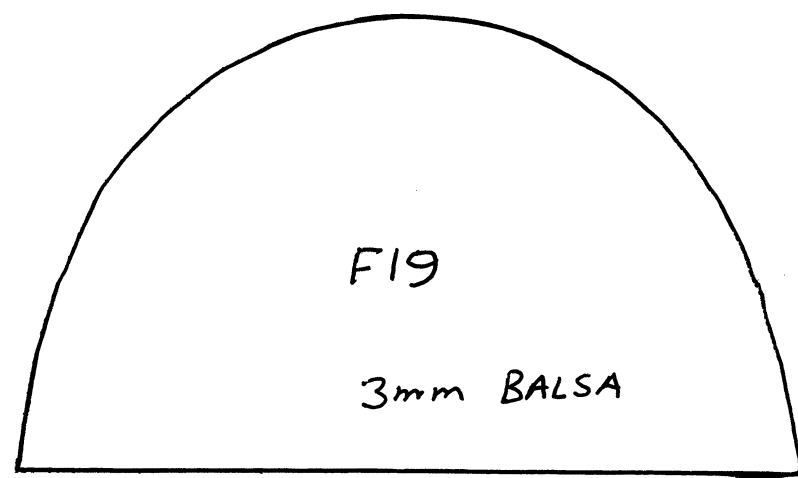
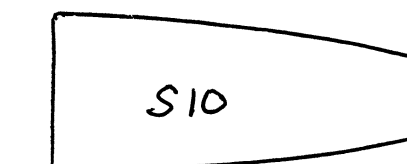
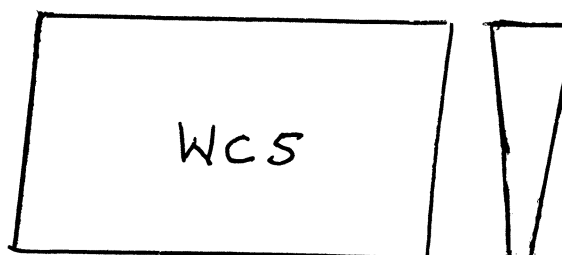
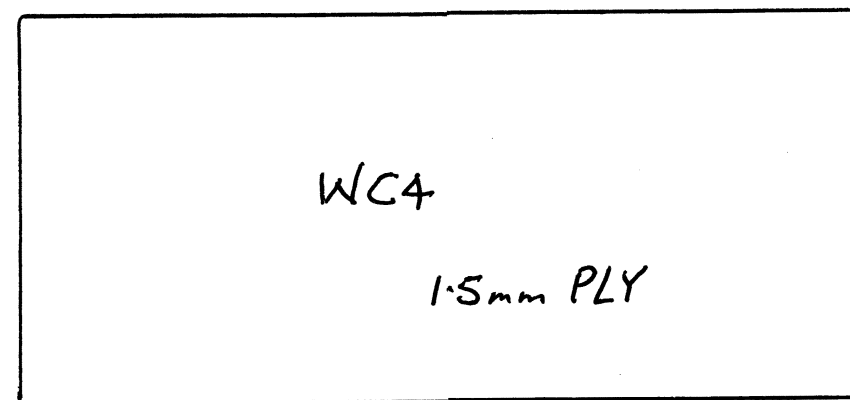
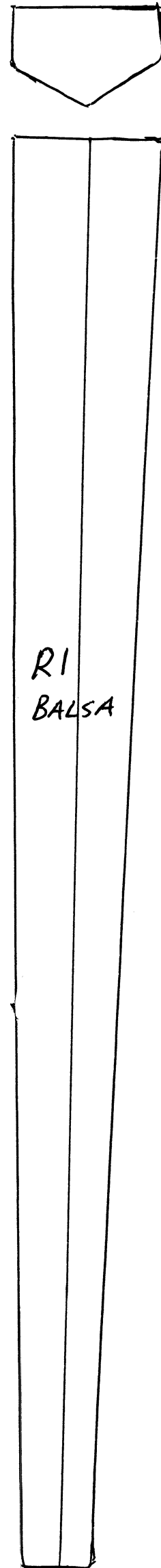
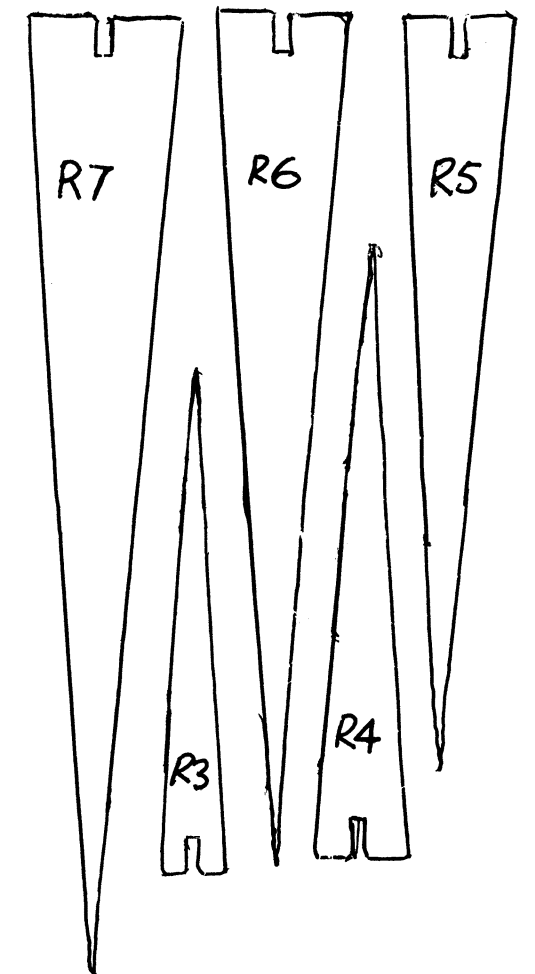
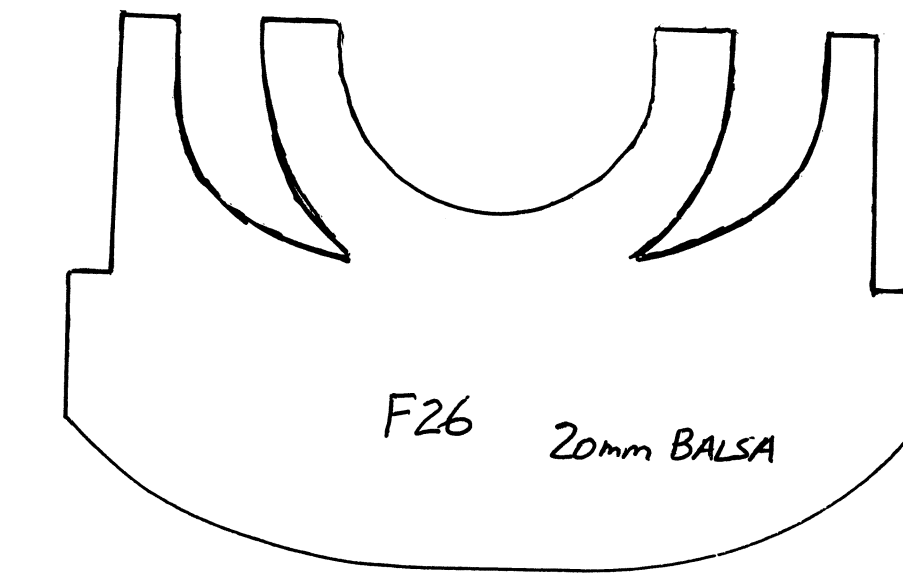
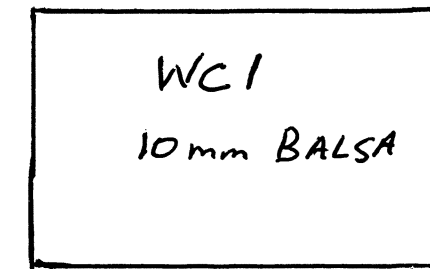
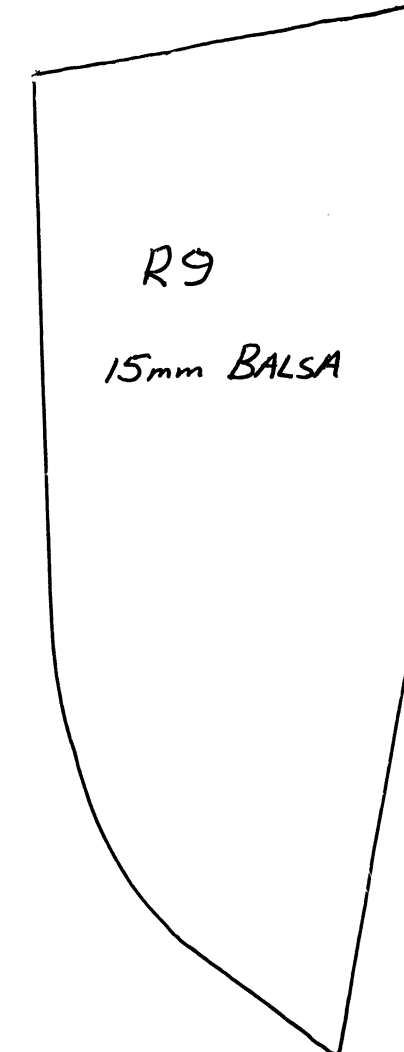
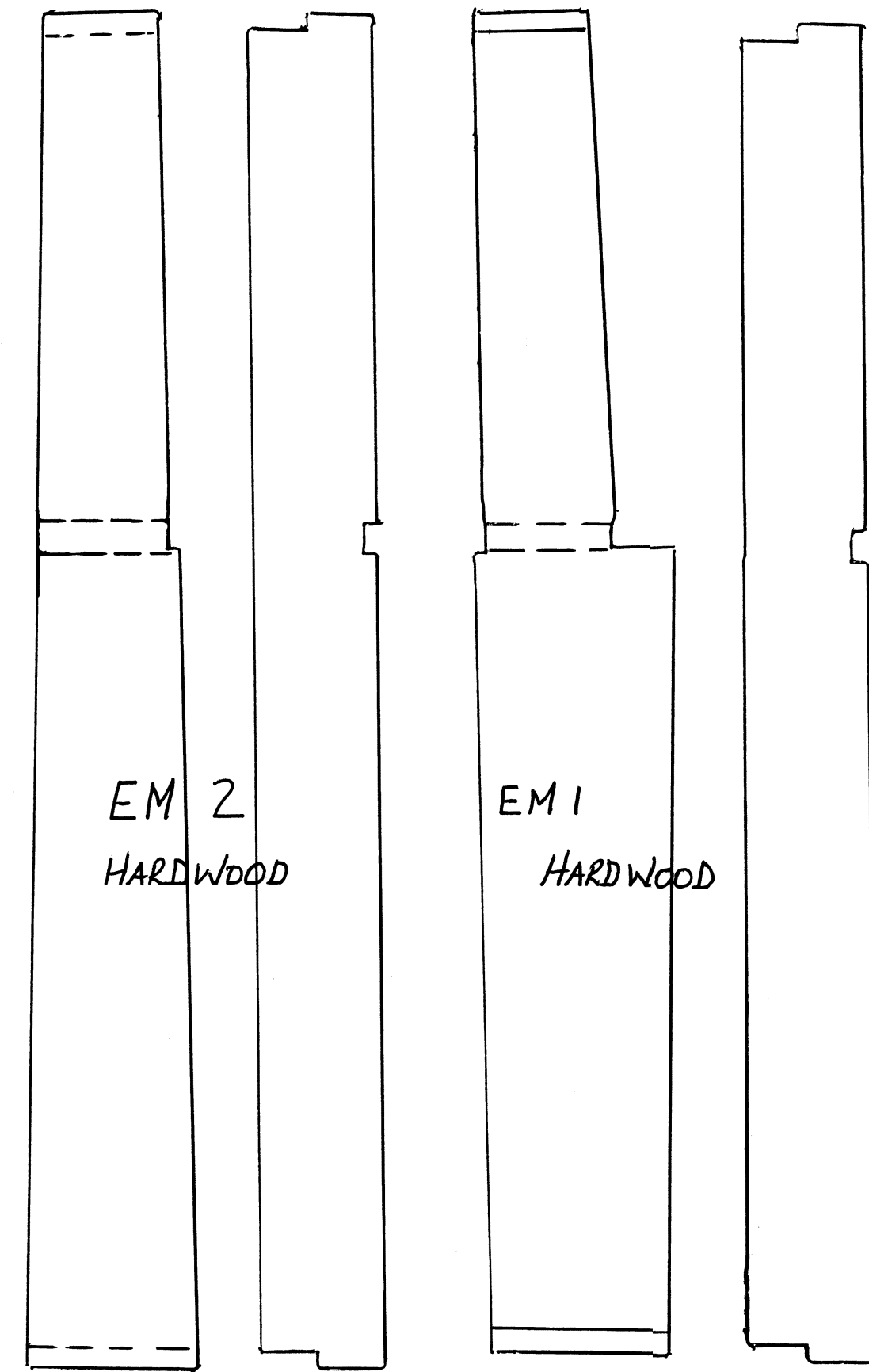
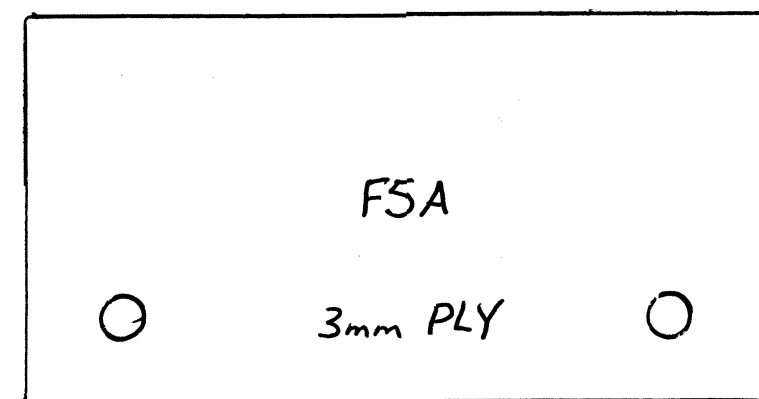
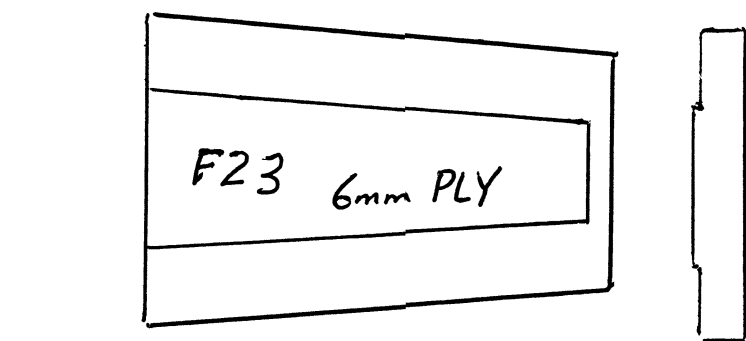
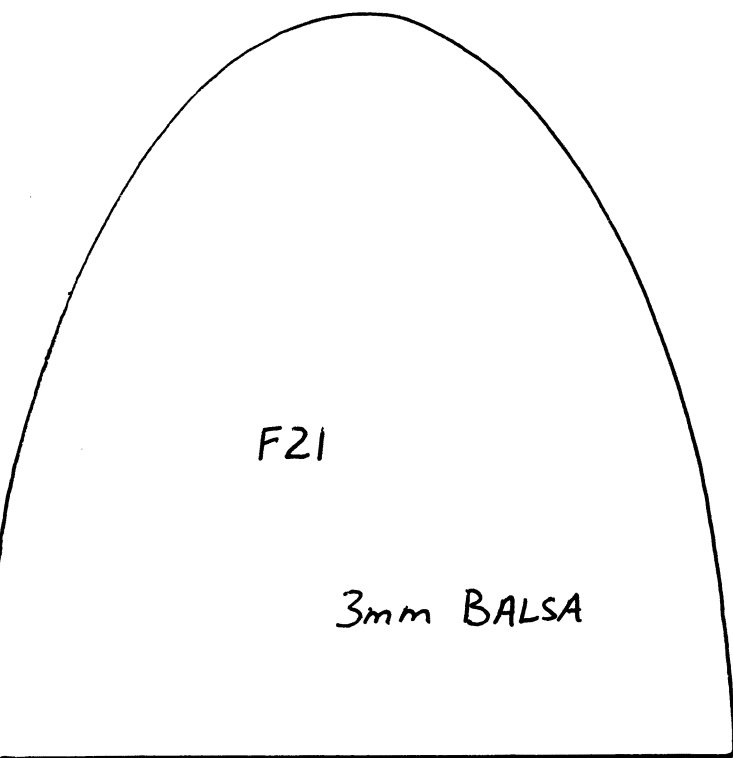
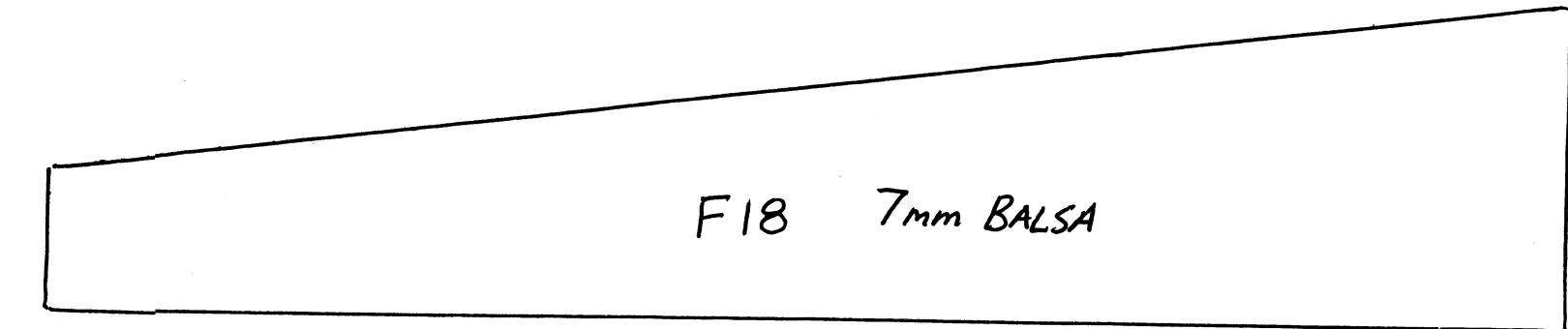
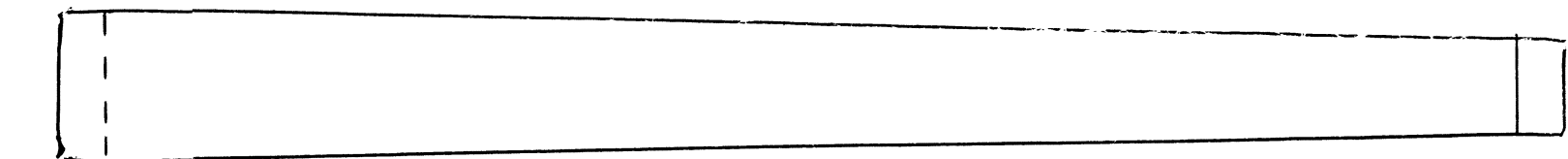
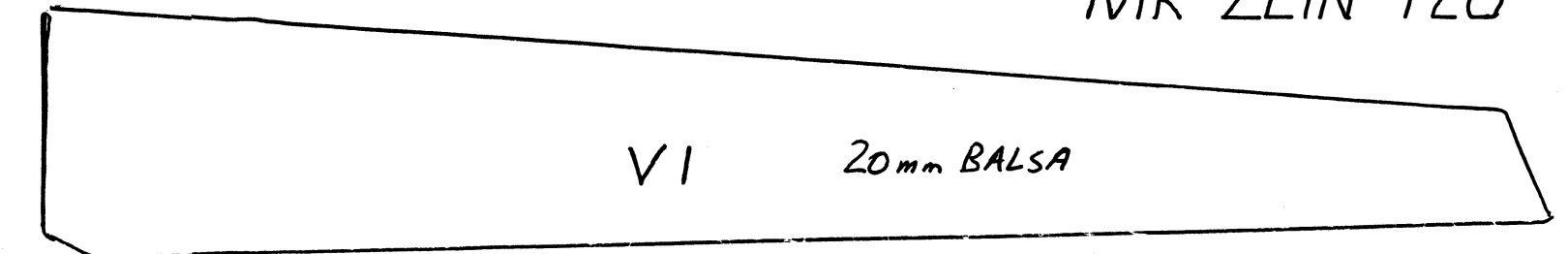
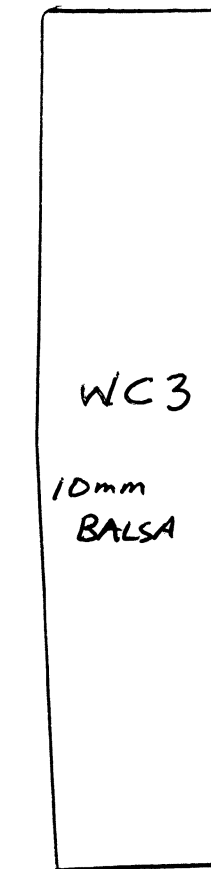
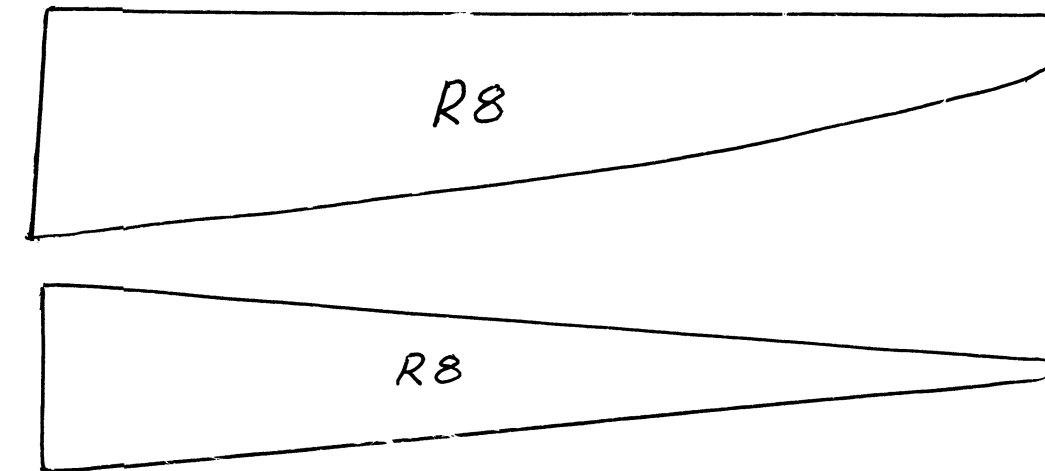
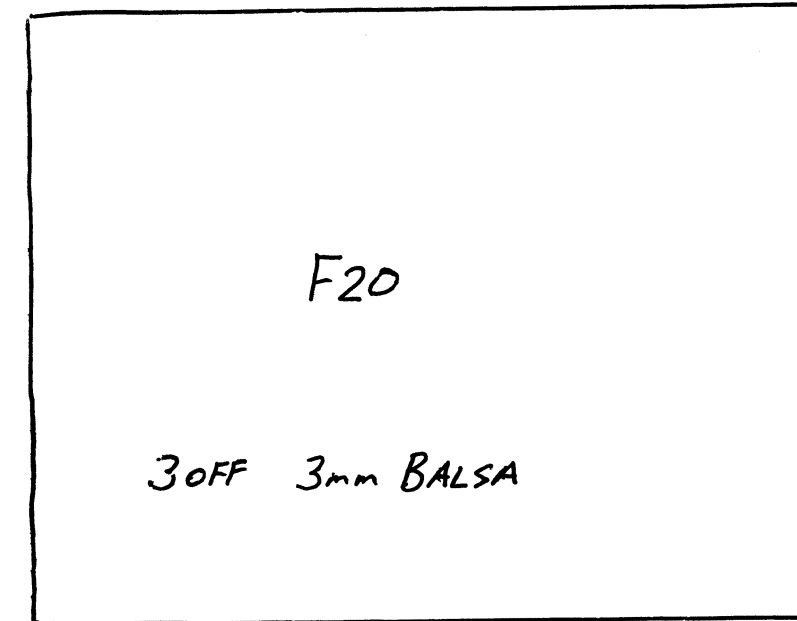
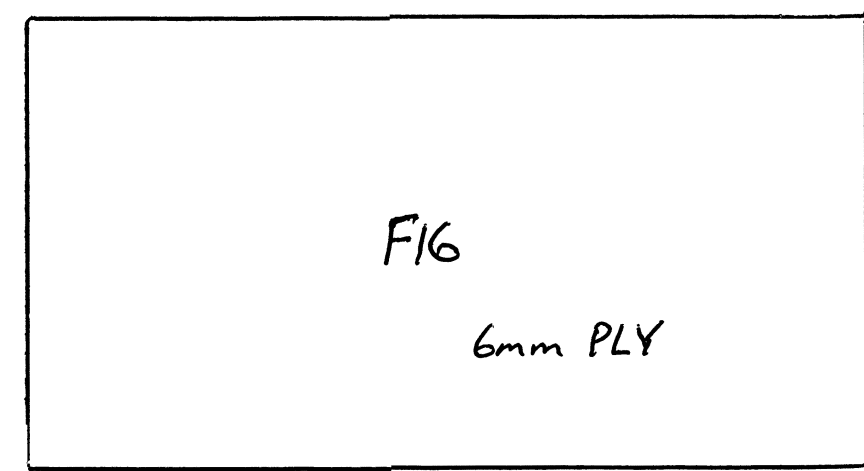
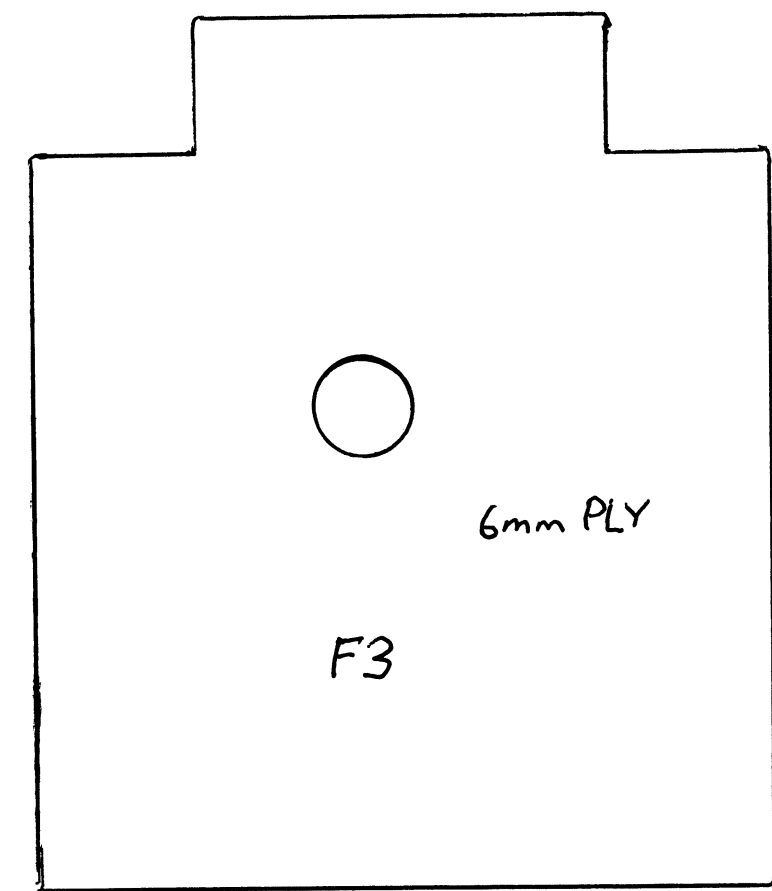

MK ZLIN 120

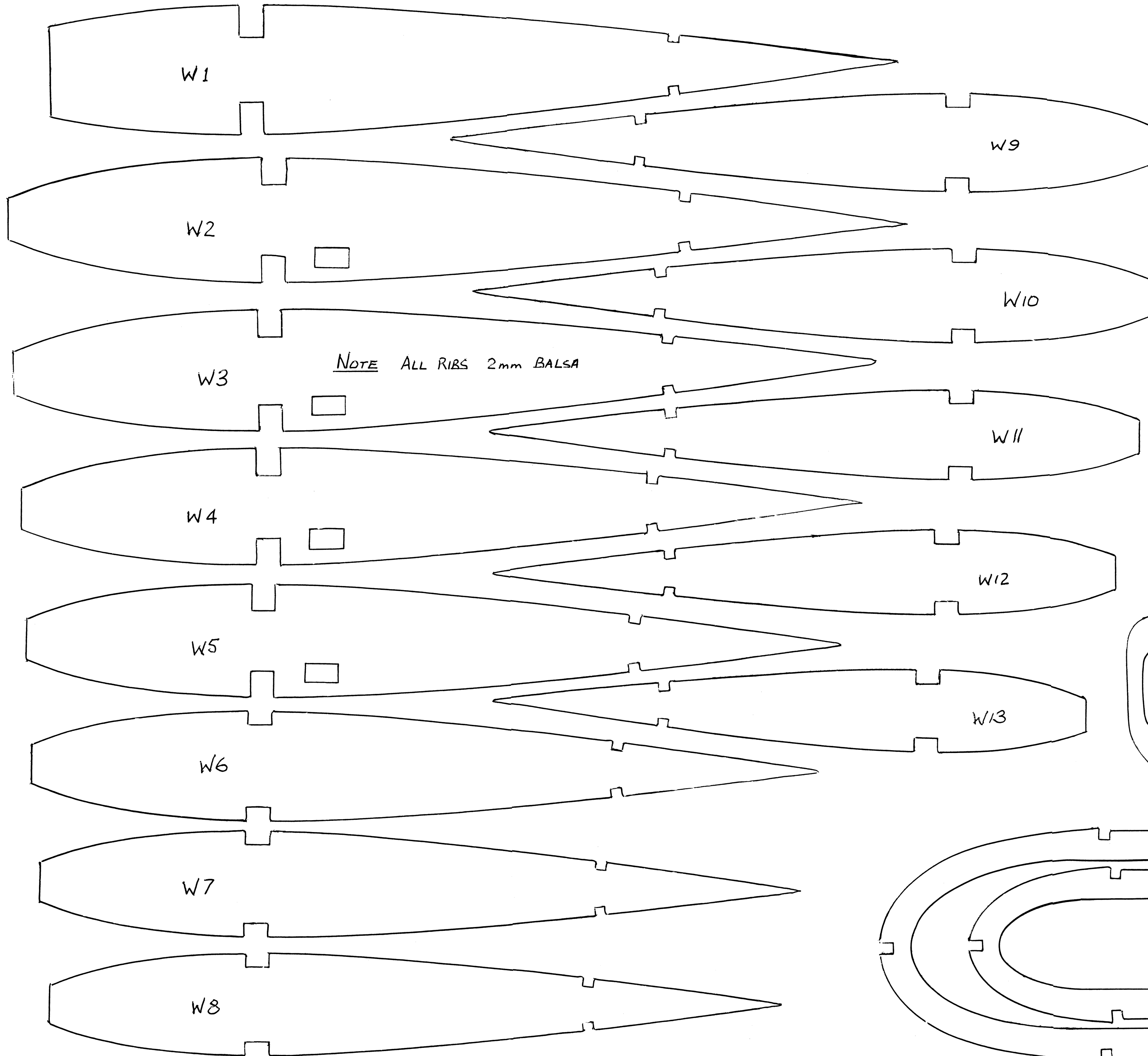

NOTE ALL RIBS 2mm Balsa

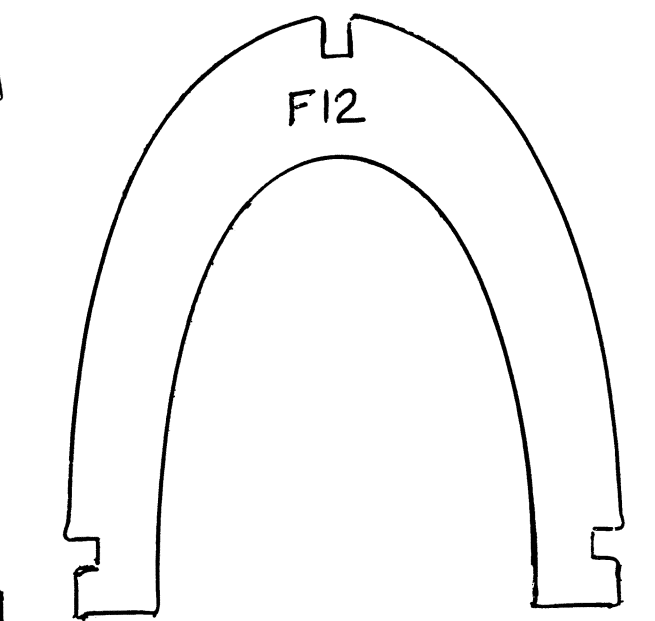
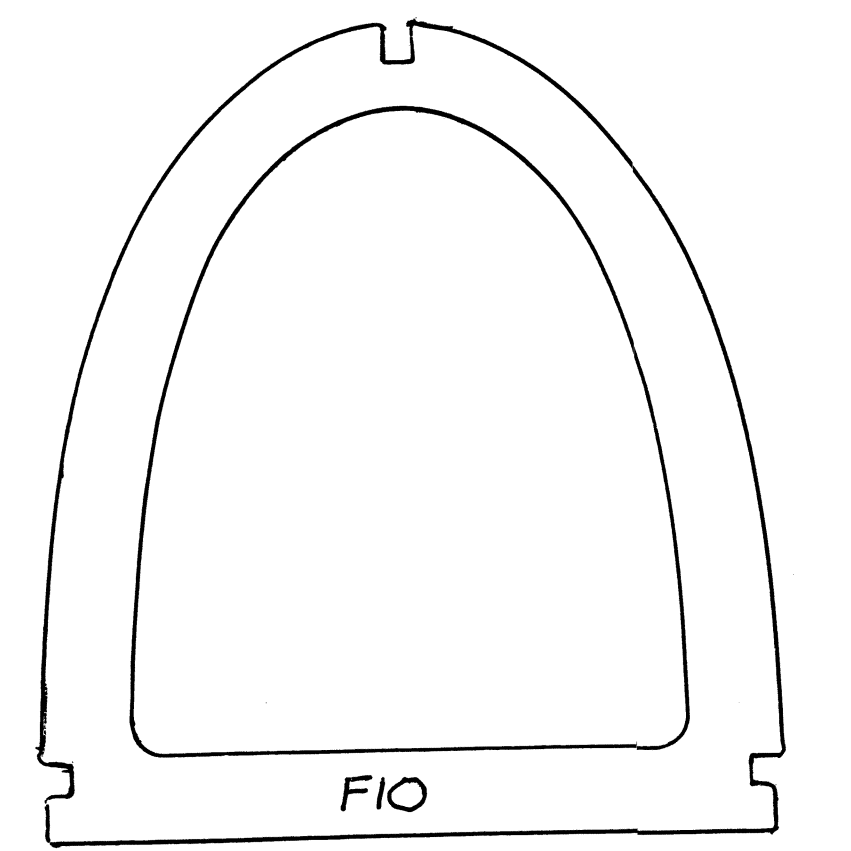
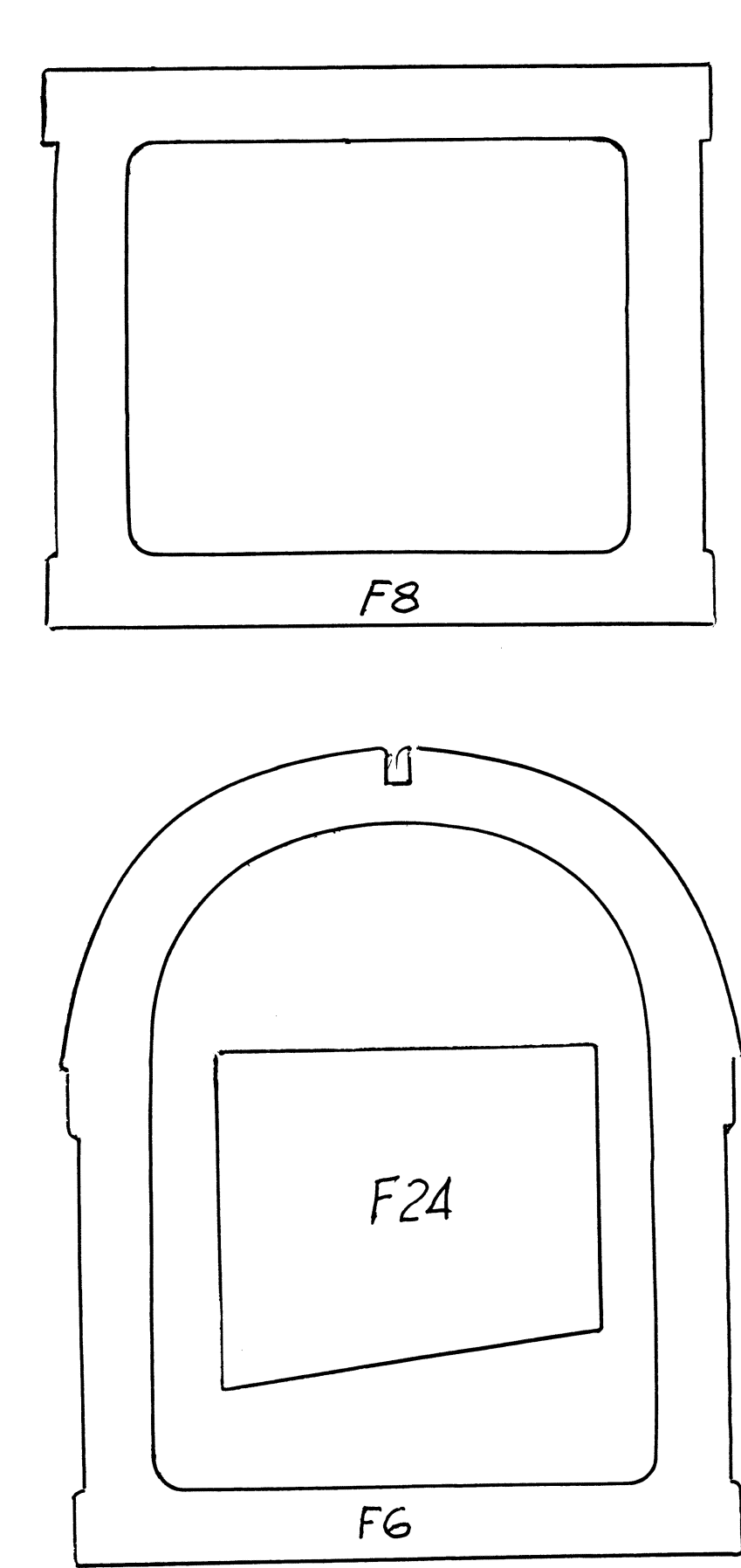
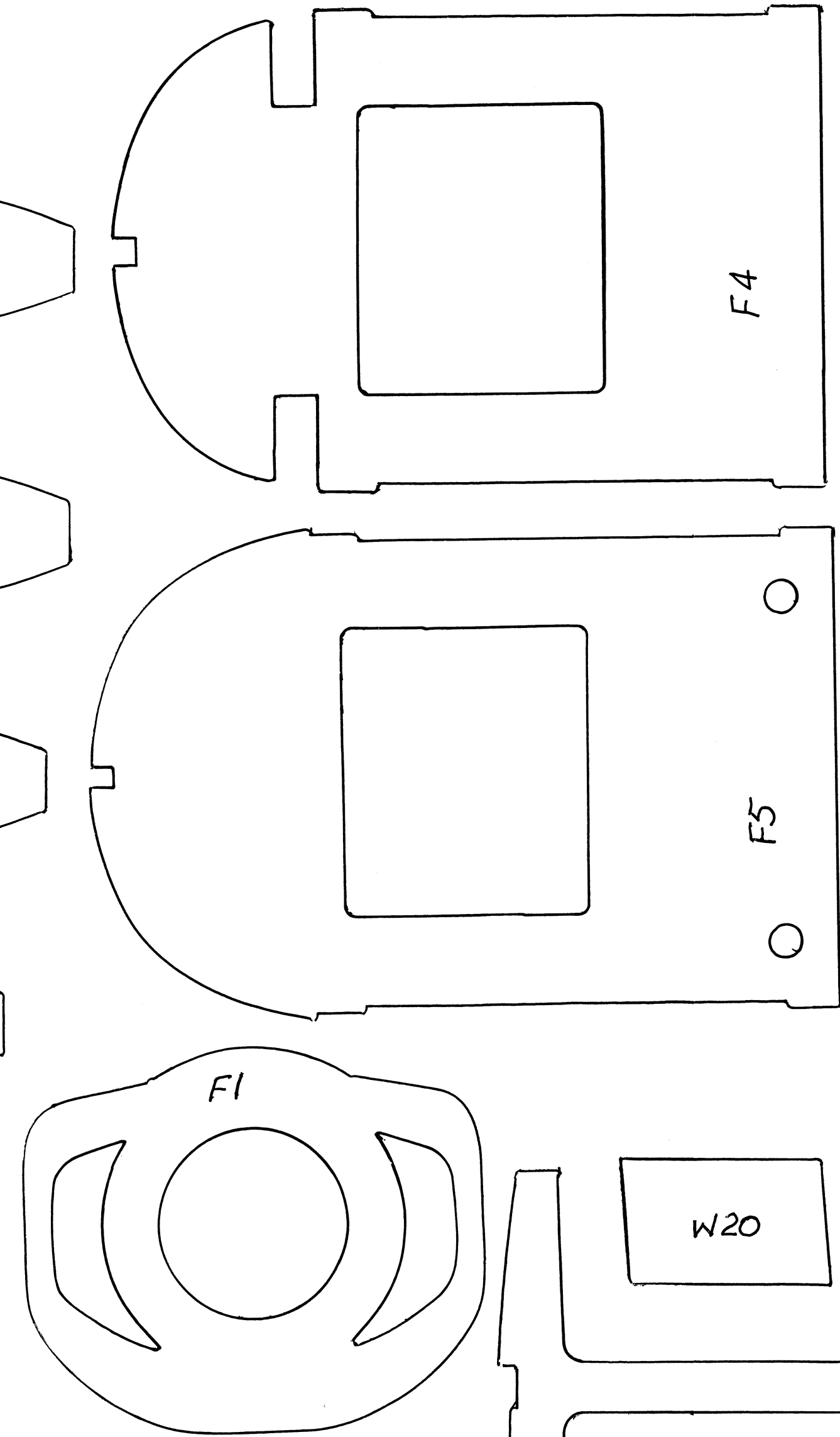
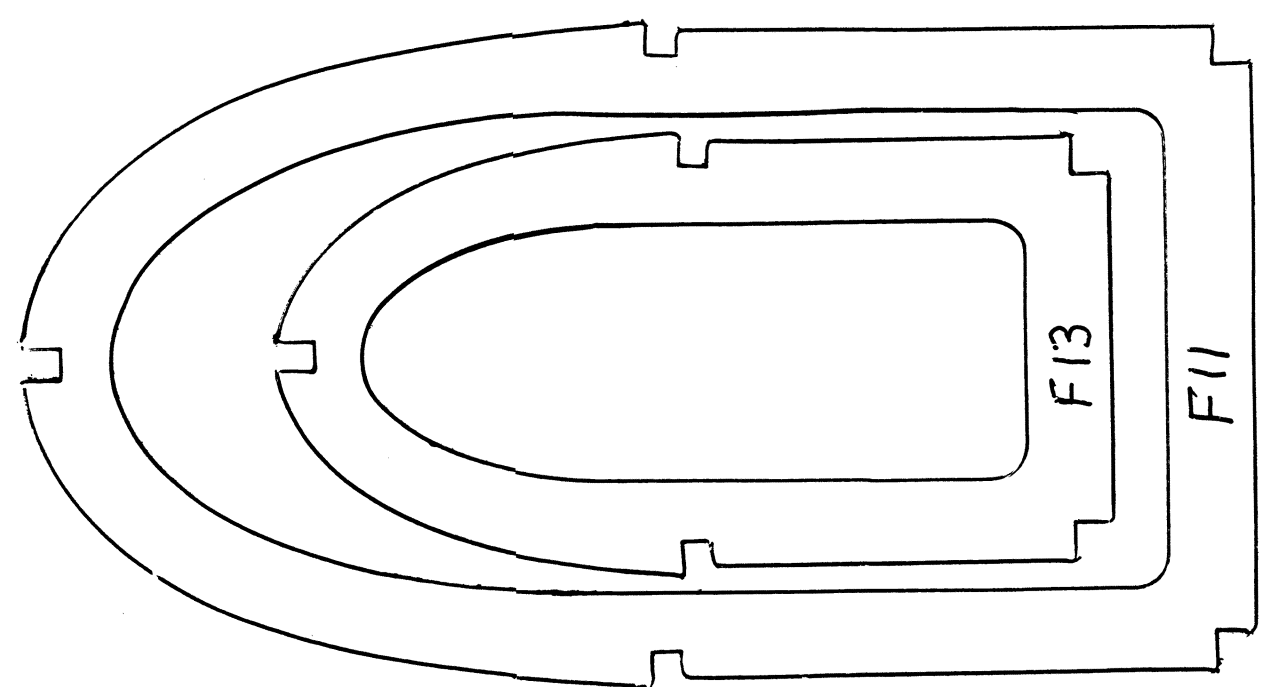
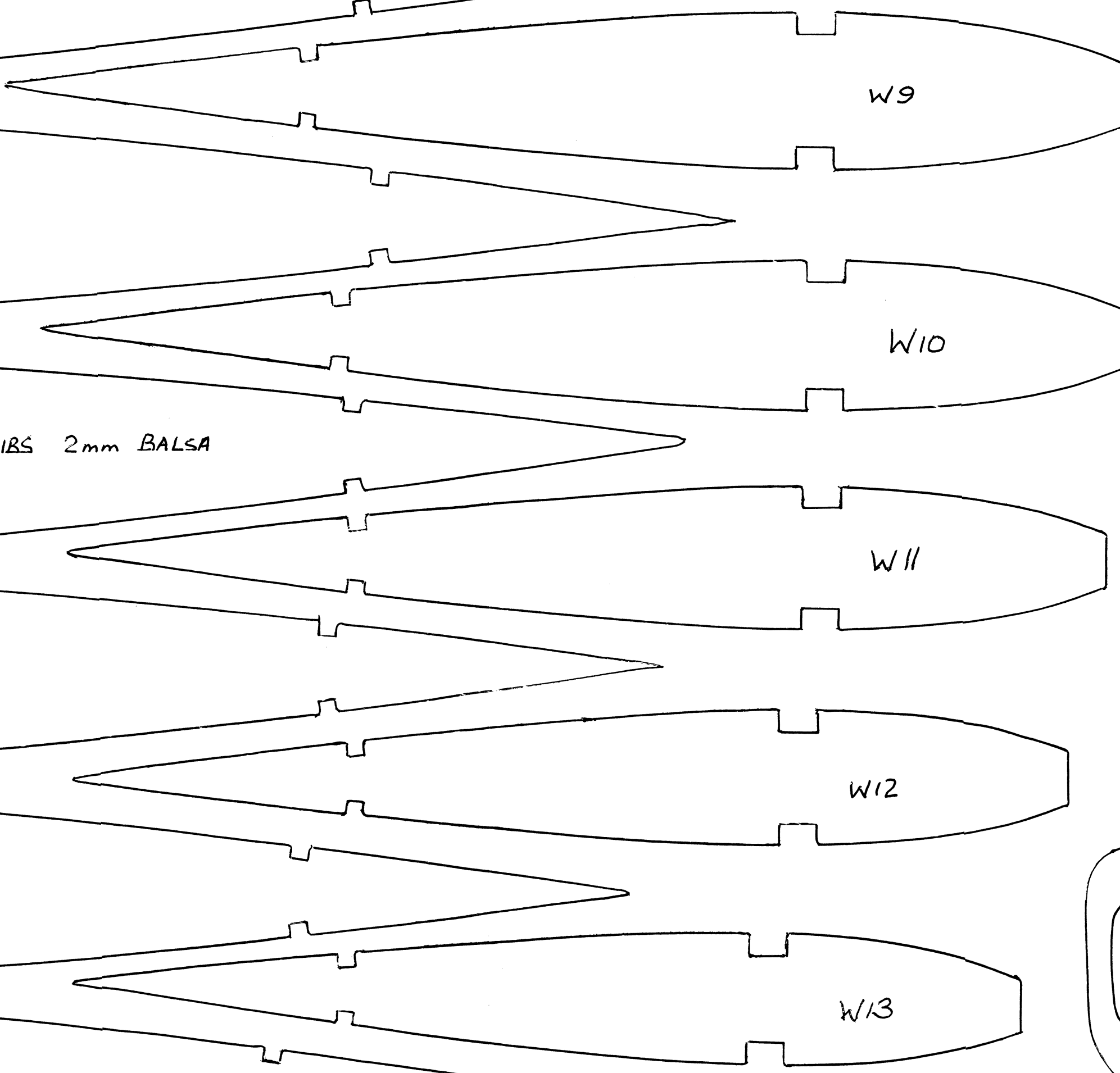

FORMERS 3mm PLY

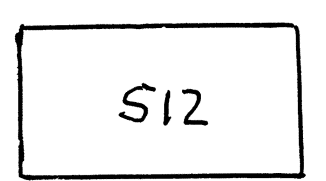
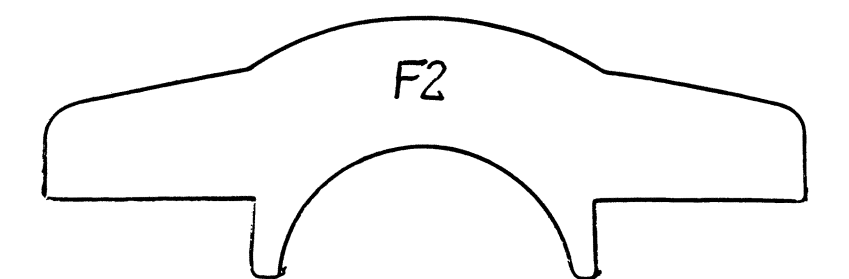
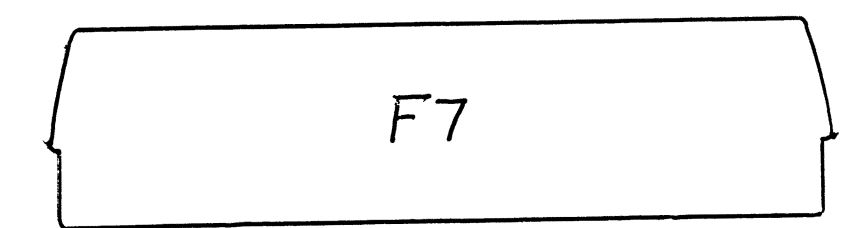
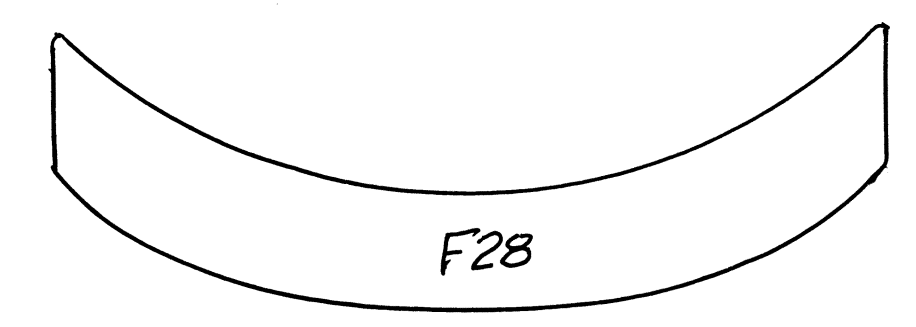
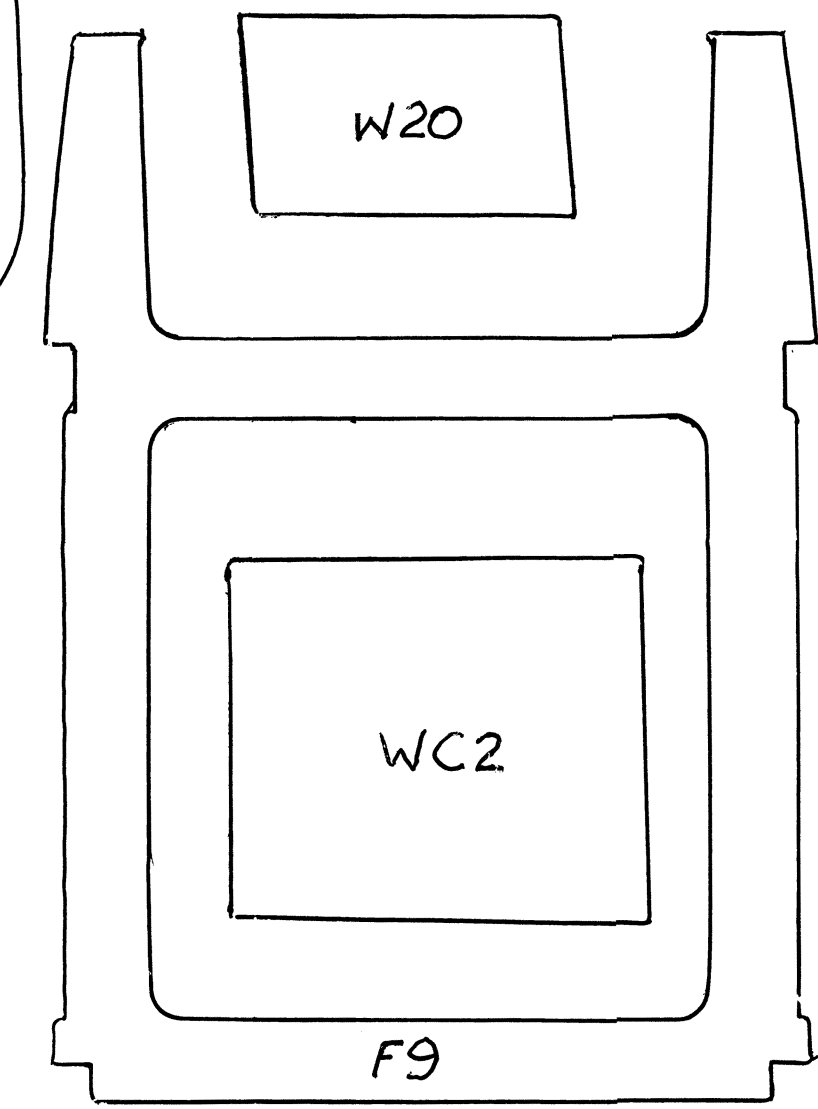

15 PLY
F29

