

DUMMY V-8 ENGINE
MAKE FROM Balsa,
PLYWOOD AND ALUM.

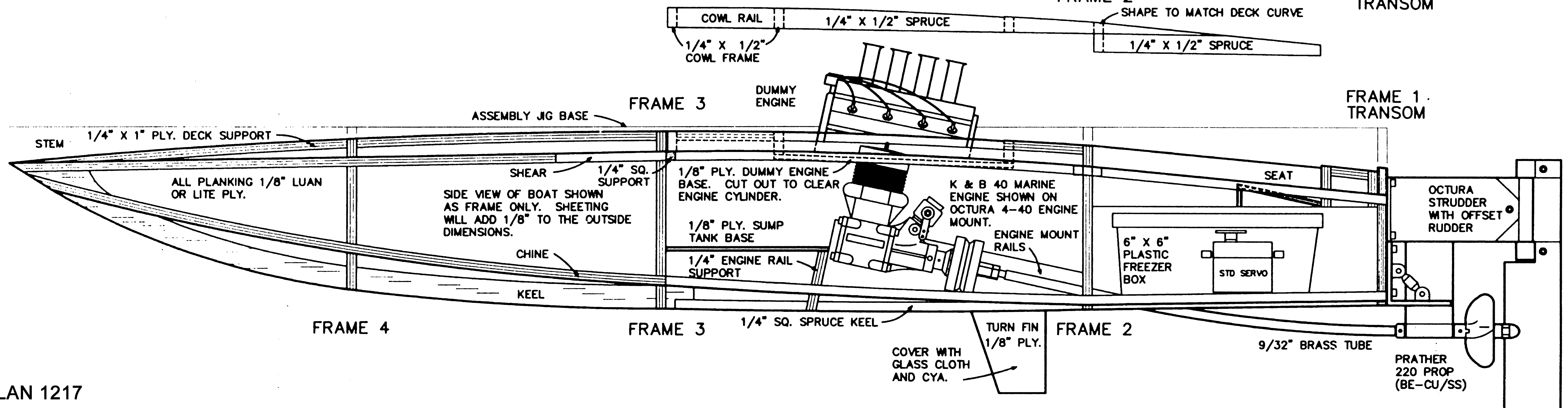
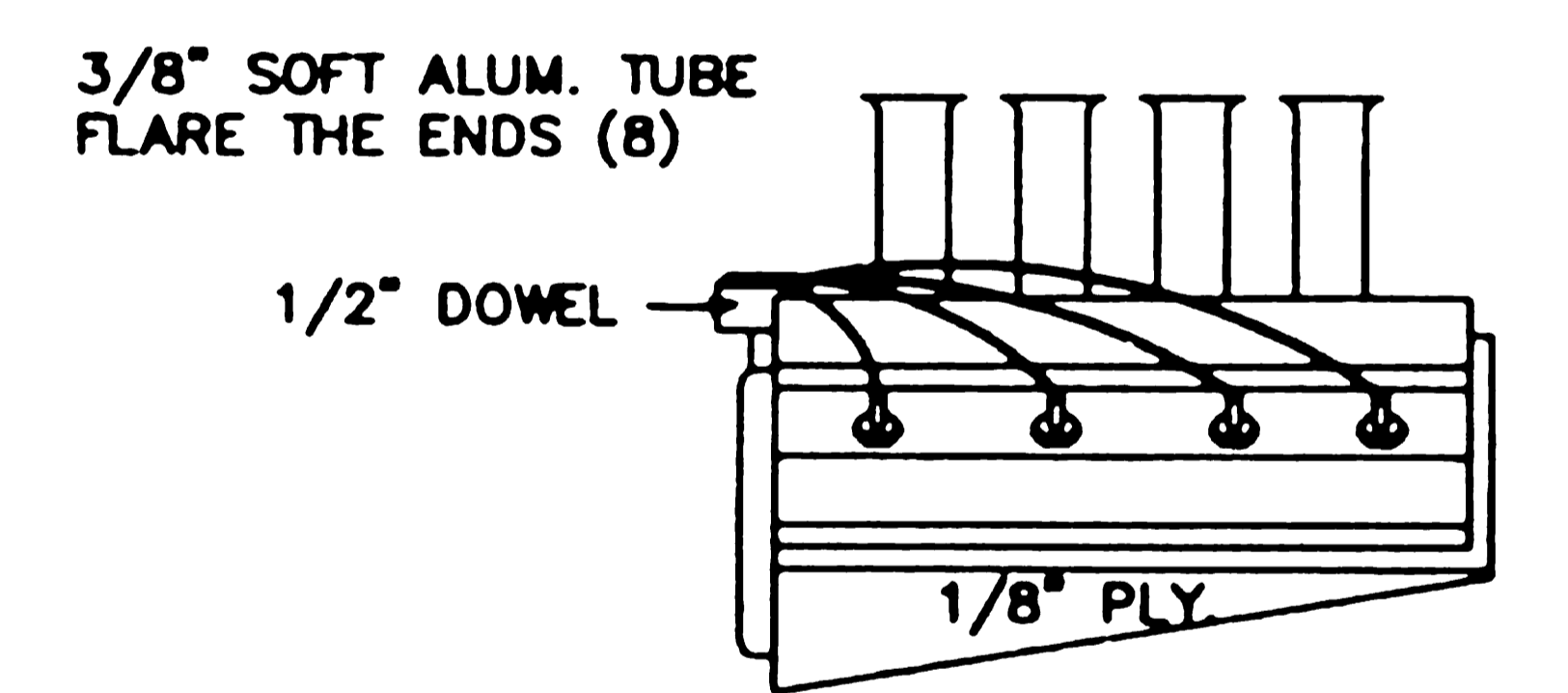
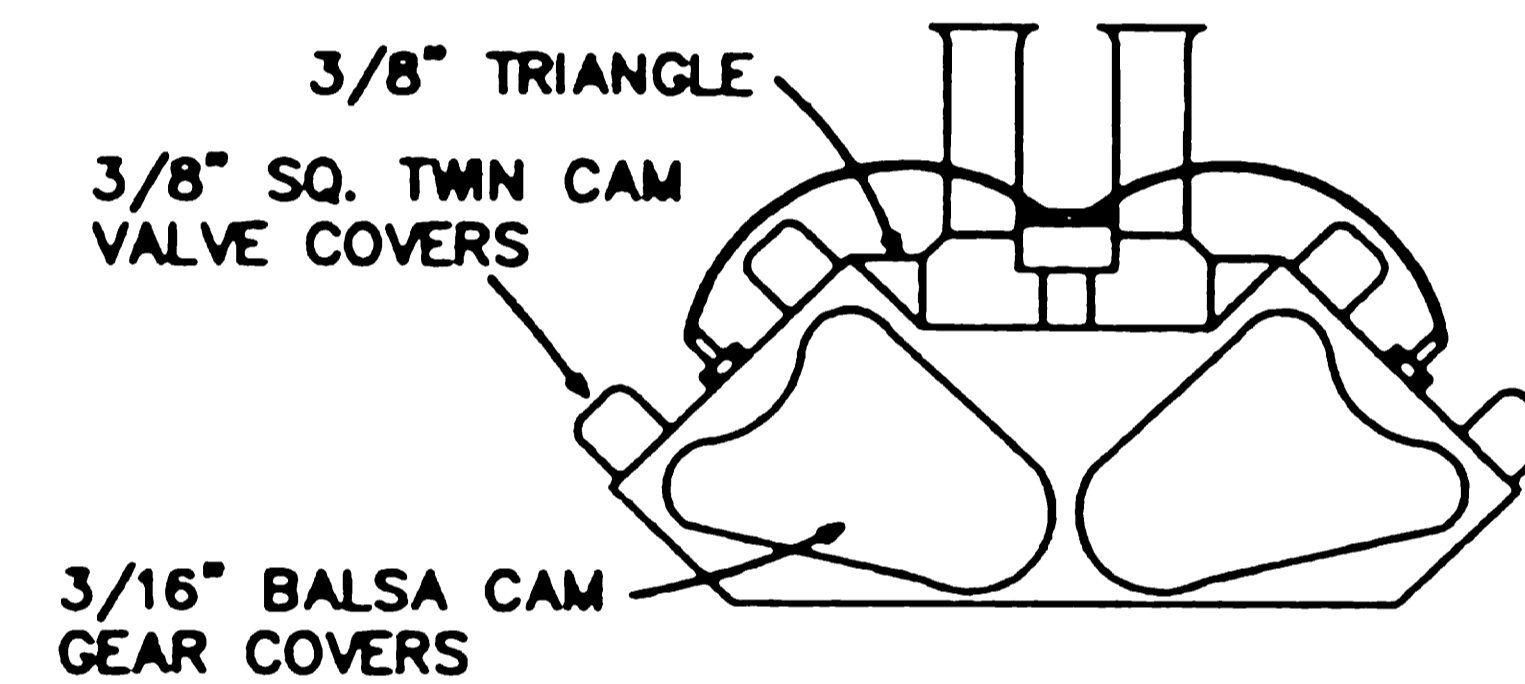
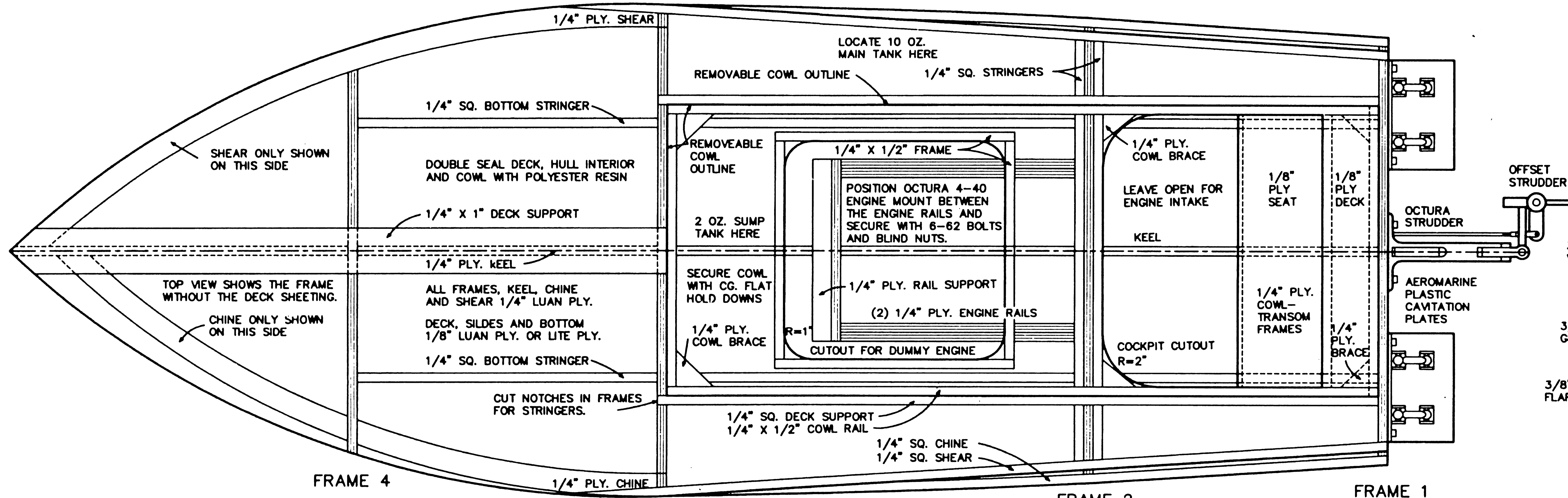
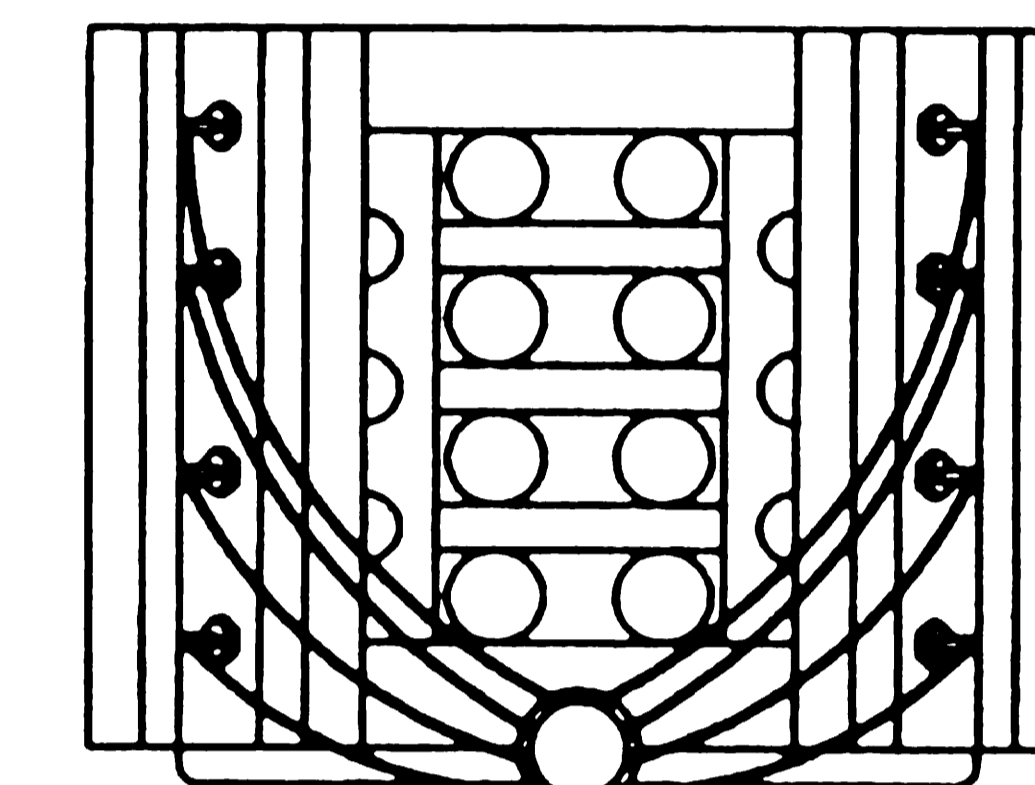

LENGTH	37"
BEAM	13.5"
ENGINE	40 CU. IN.
RADIO	2 CHANNEL

© 1988 ALL DIMENSIONS IN INCHES UNLESS NOTED OTHERWISE

INBOARD SPORT RACE BOAT
40 CRACKER BOX

DESIGNED AND DRAWN BY TOM ROSLING
CAD DRAWING BY FRED REESE

CUT OFF BUILDING TAPS AFTER GLUING ON SIDES AND BOTTOM.

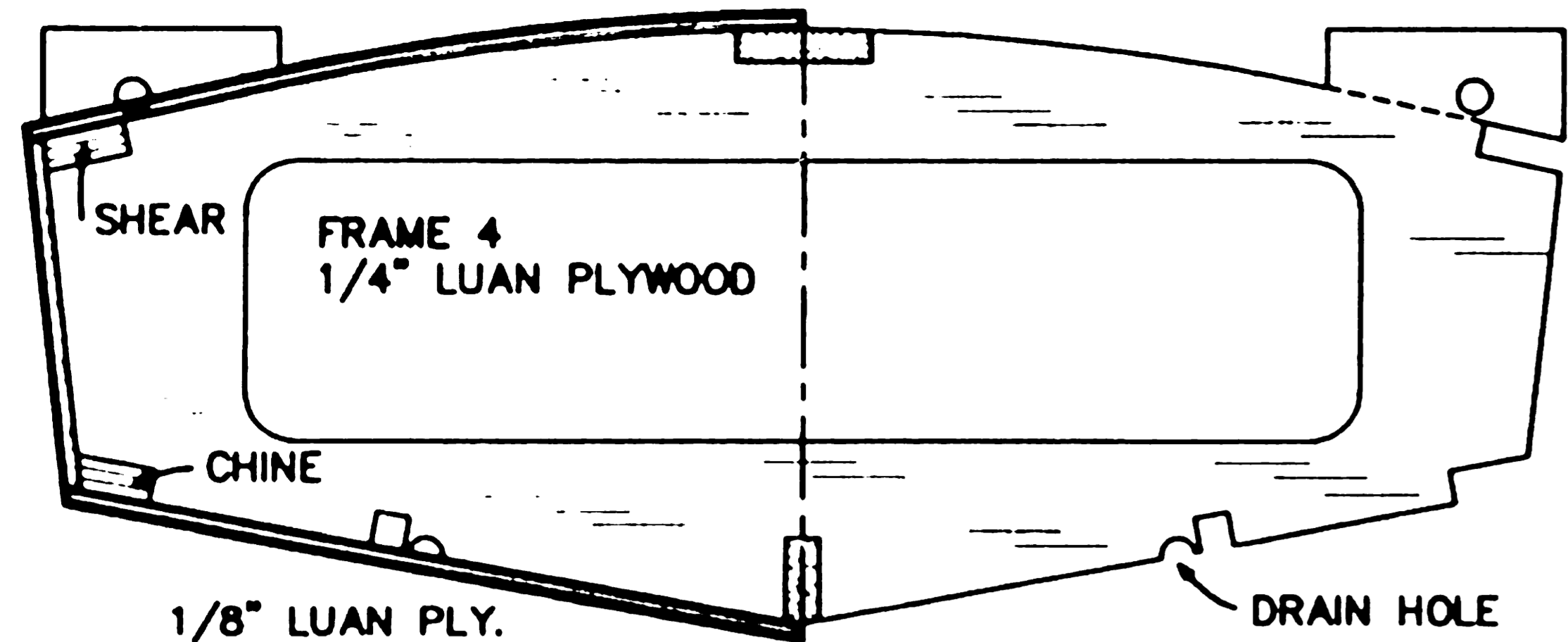

1/8" LUAN PLY. BOTTOM, SIDES AND DECK

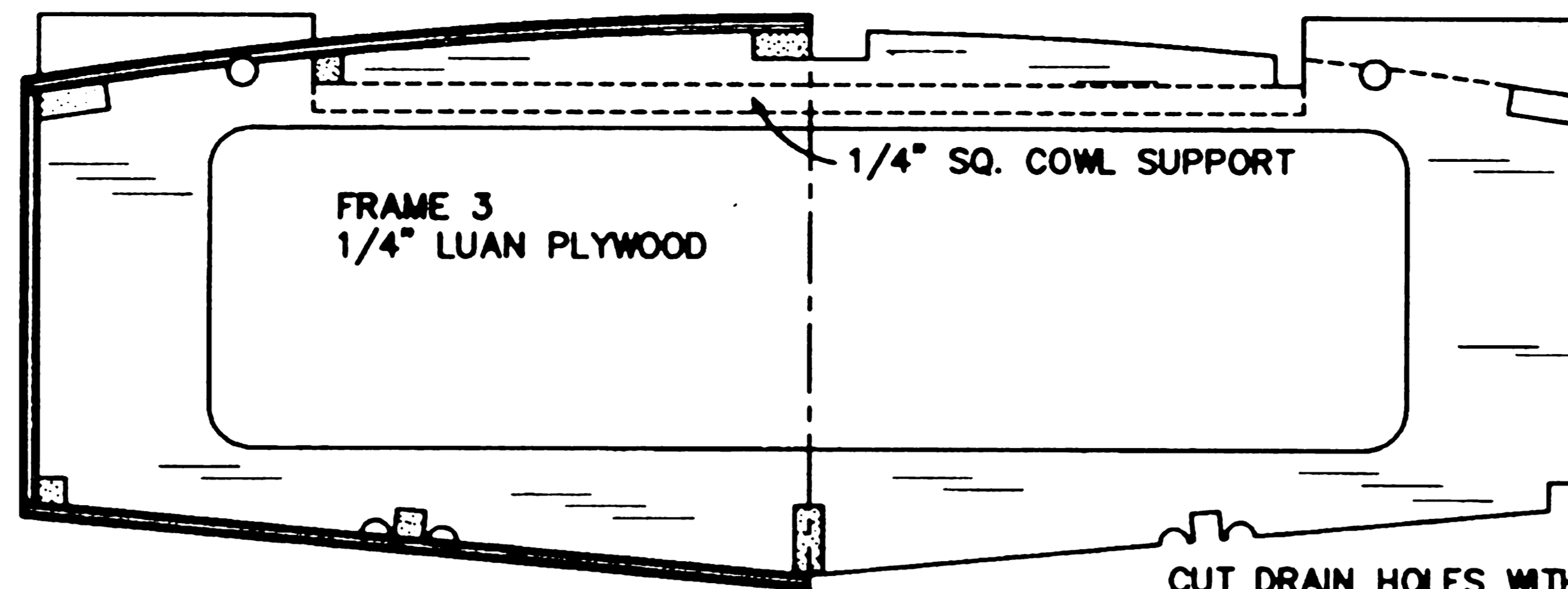

CUT DRAIN HOLES WITH DREMEL TOOL BEFORE GLUING ON BOTTOM.

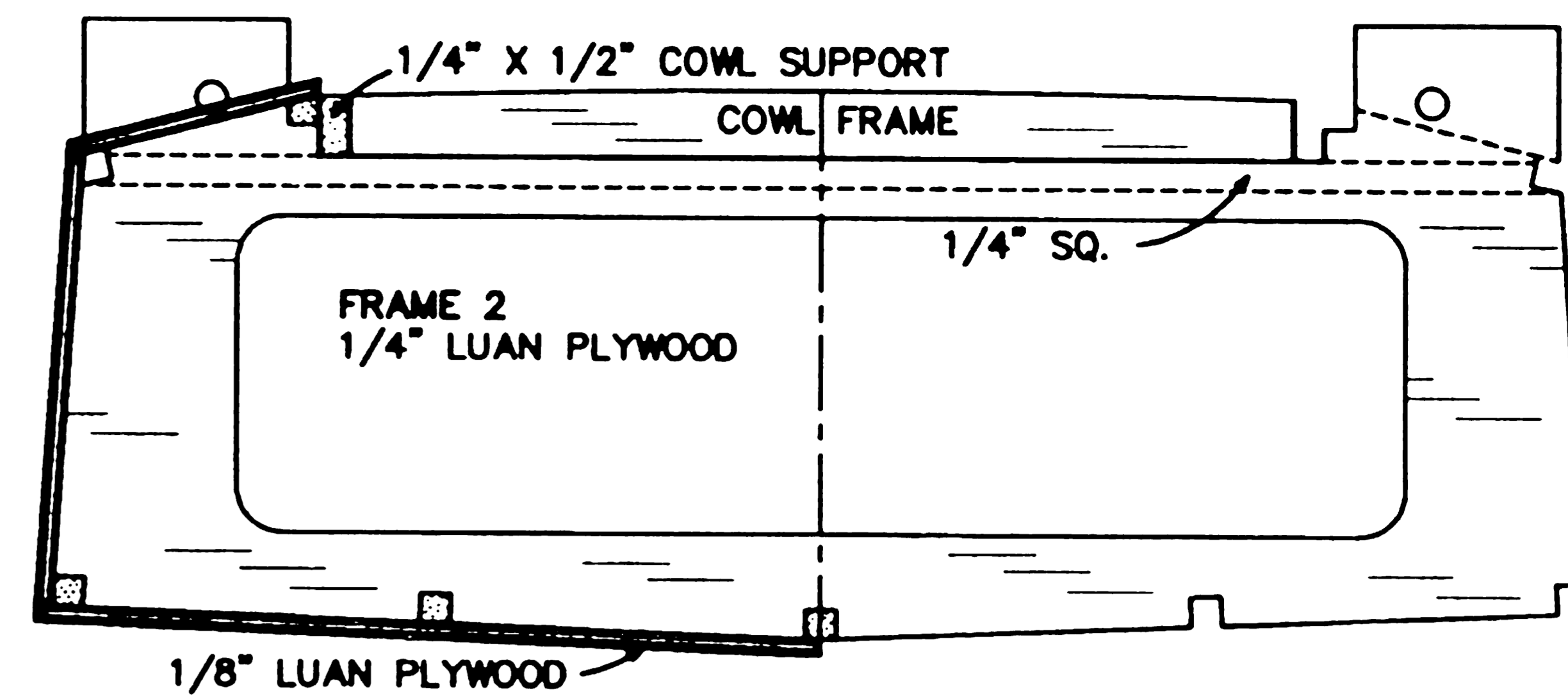

1/8" LUAN PLYWOOD

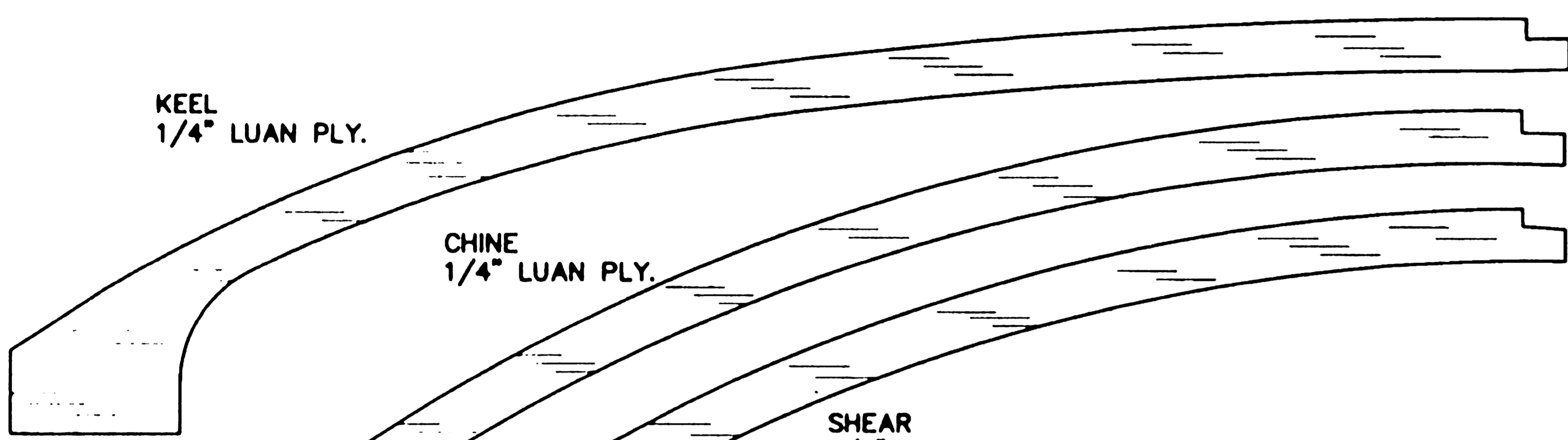

SHEAR 1/4" LUAN PLY.

NOTCH CHINE AND SHEAR TO FIT FRAME 4.

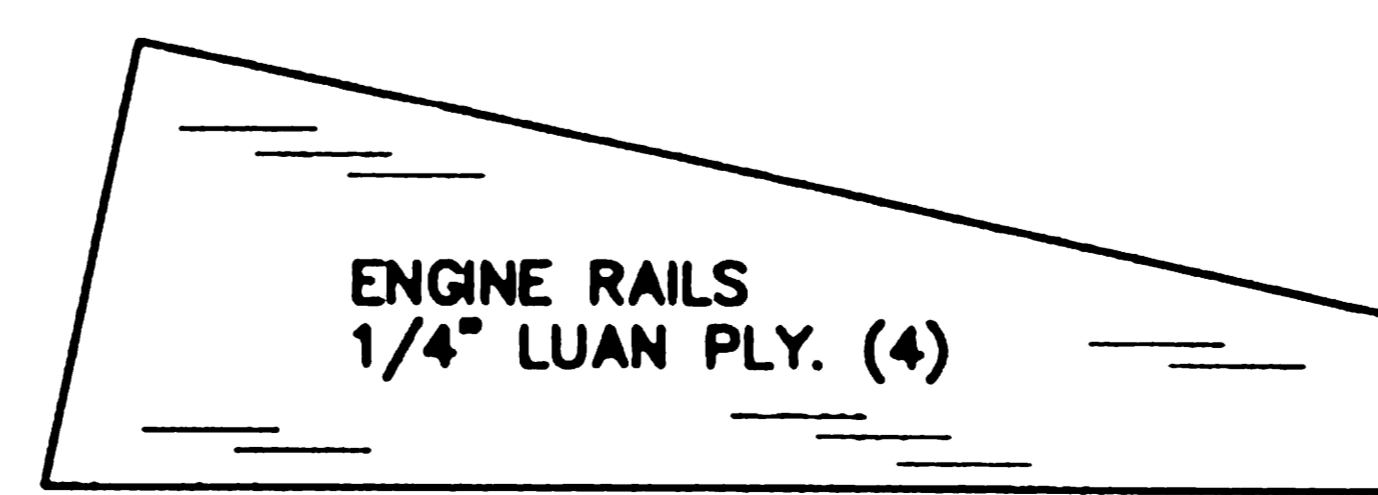
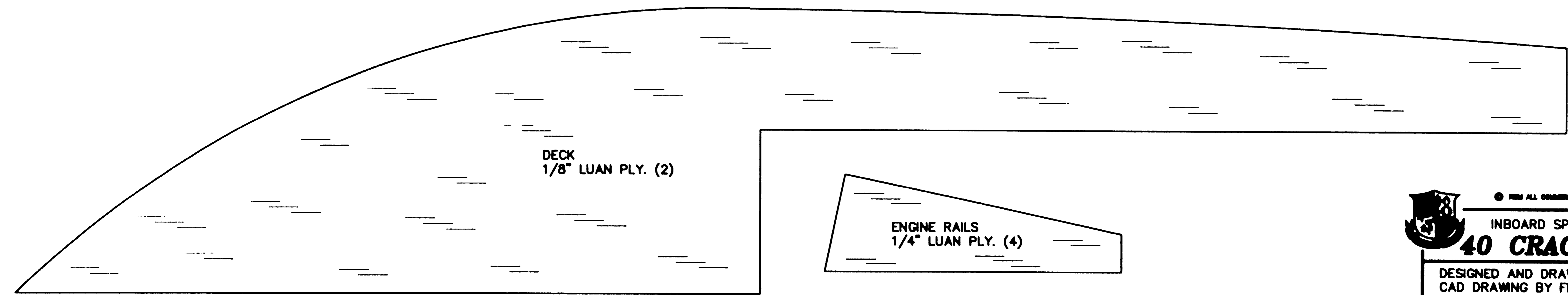
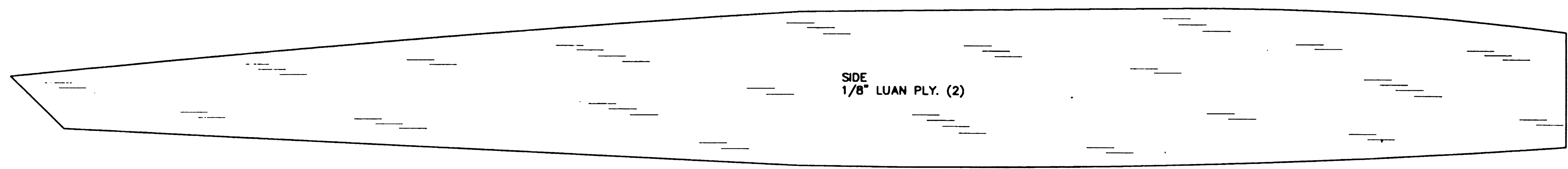
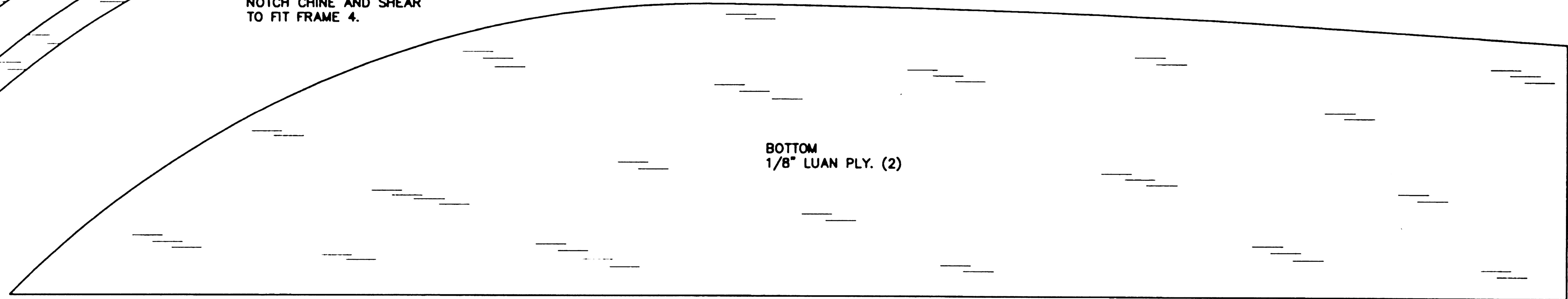
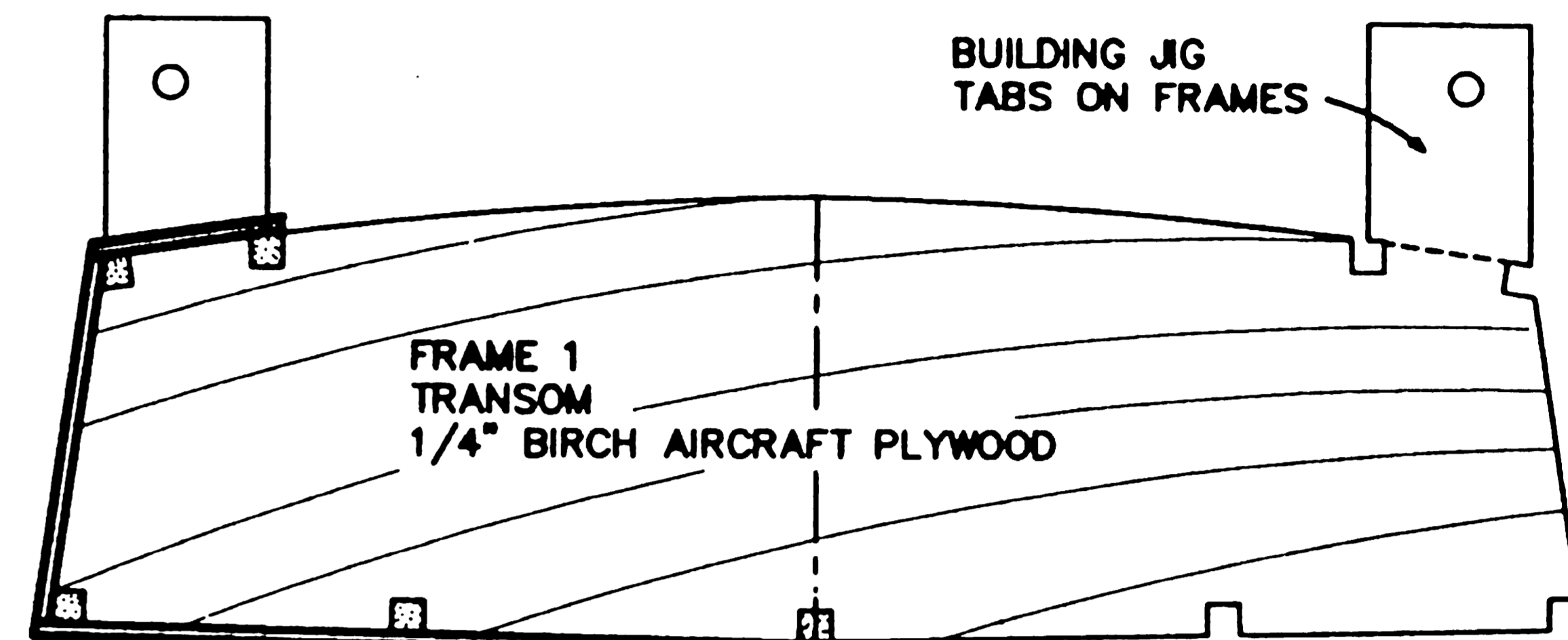

© 1988 ALL RIGHTS RESERVED

INBOARD SPORT RACE BOAT
40 CRACKER BOX

DESIGNED AND DRAWN BY TOM ROSLING
CAD DRAWING BY FRED REESE

PAGE TWO
PART SHEET

