

CHIEF
Plate 1

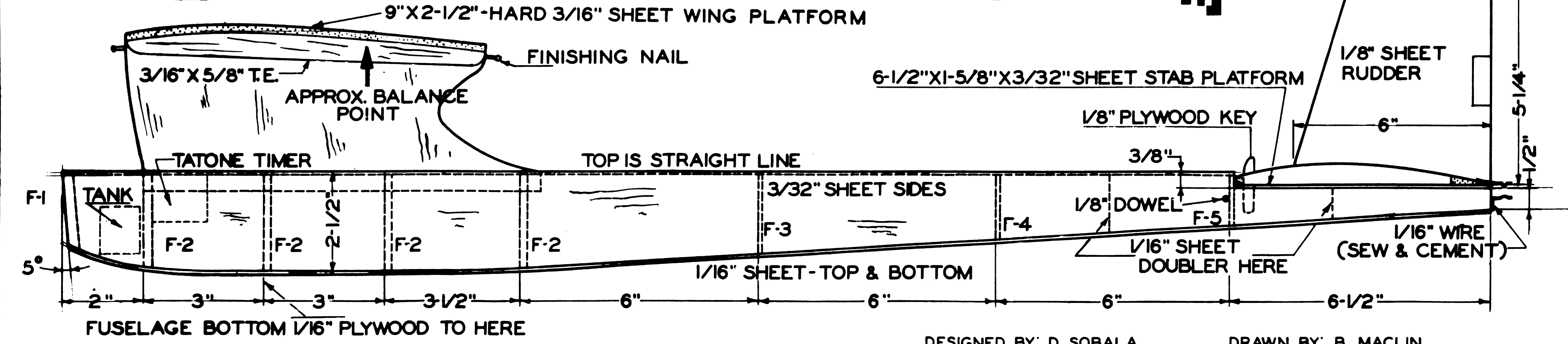

DESIGNED BY: D. SOBALA

DRAWN BY: B. MACLIN

ALL FULL WING RIBS - 3/32" SHEET
ALL 1/3 AND 2/3 RIBS - 1/16" SHEET

PYLON - 1/4" SHEET

W-7 TO HERE

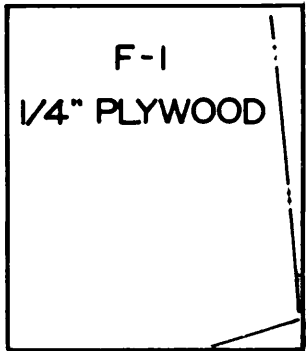
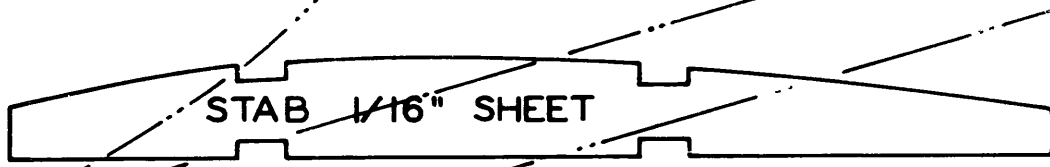
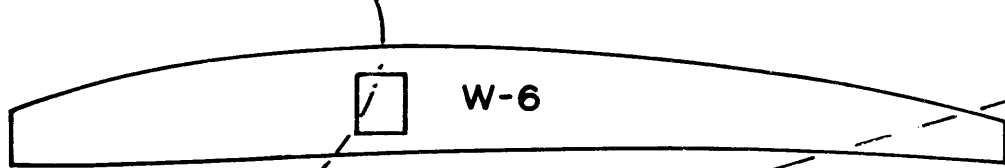
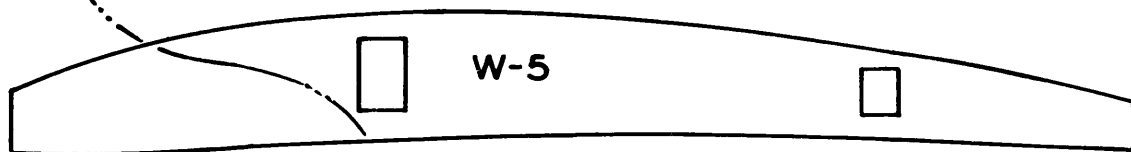
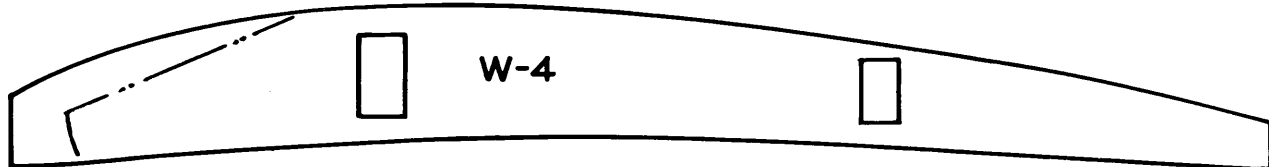
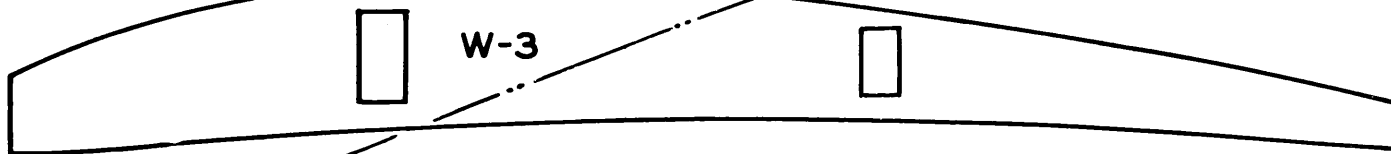
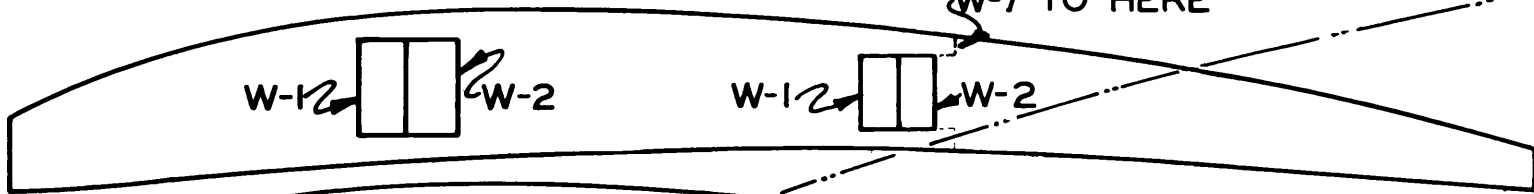

CEEF
Plate 2

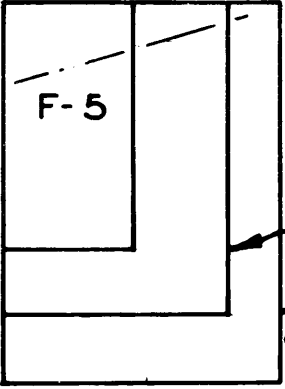
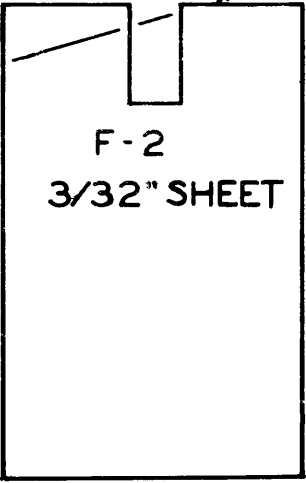

F3, F4, F5 1/8" SHEET

FULL SIZE PARTS