

TOP SHEETING & CAP STRIPS NOT SHOWN

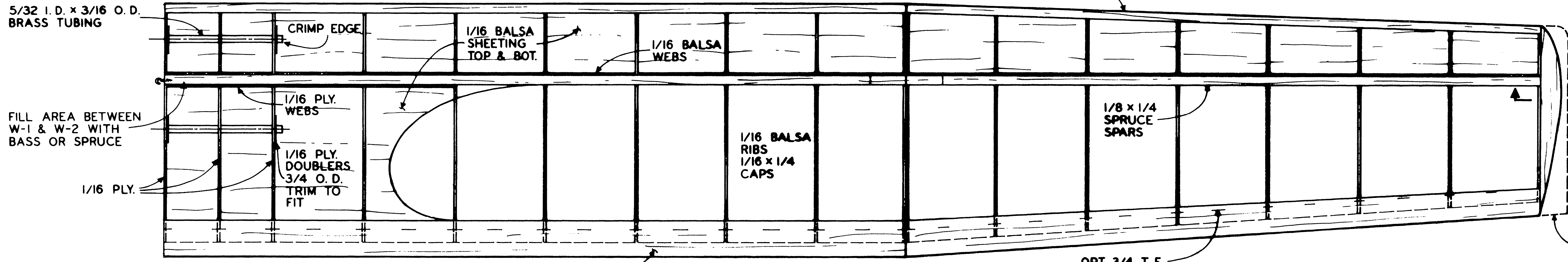

5/32 I.D. x 3/16 O.D. BRASS TUBING
FILL AREA BETWEEN W-1 & W-2 WITH BASS OR SPRUCE

1/4 BASSWOOD
OPT. 1/32 PLY.
POLYHEDRAL BRACE

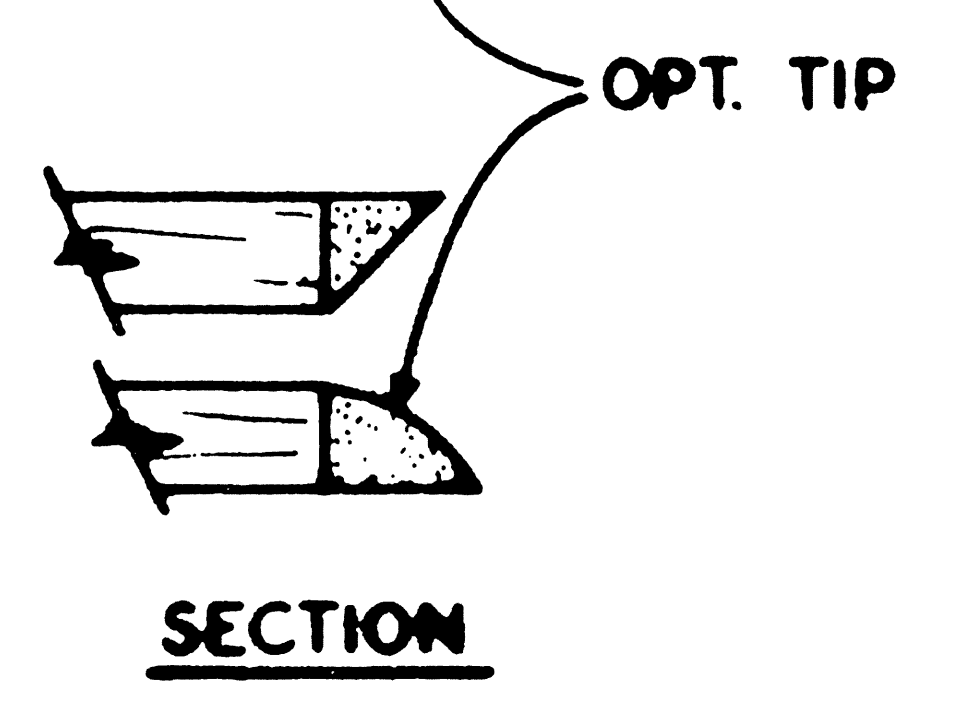

A-D 1/8 PLYWOOD
E-H 1/8 BALS

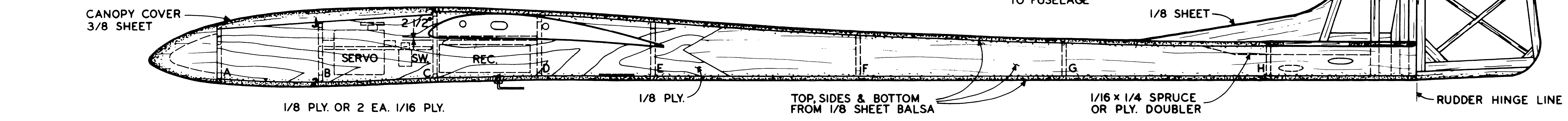
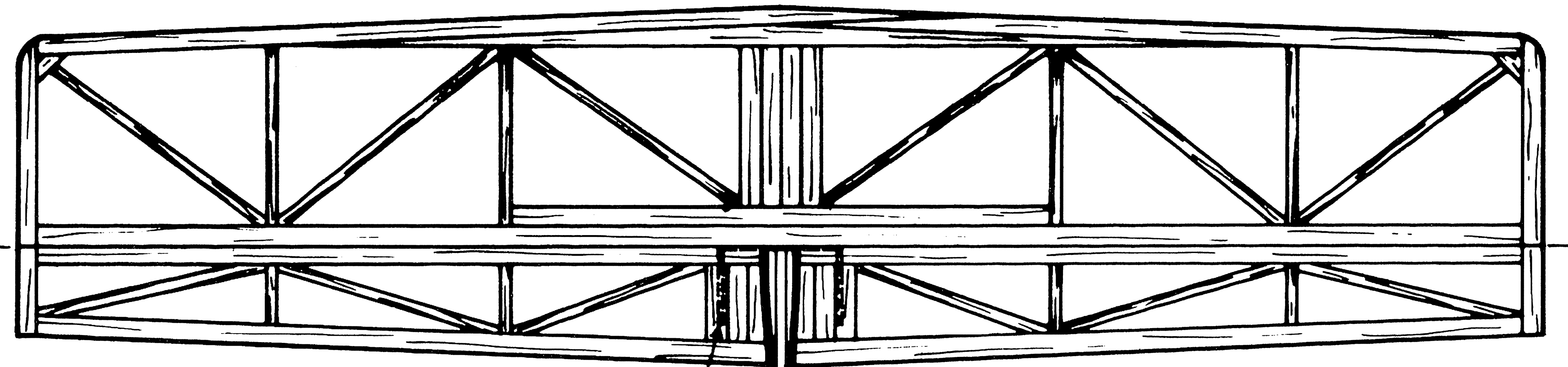
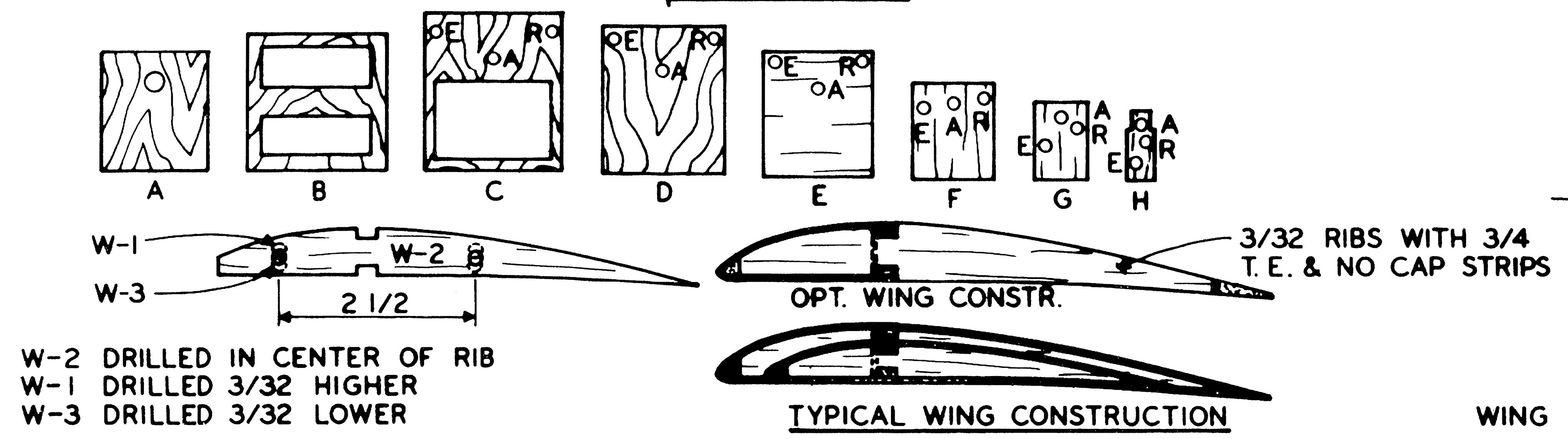
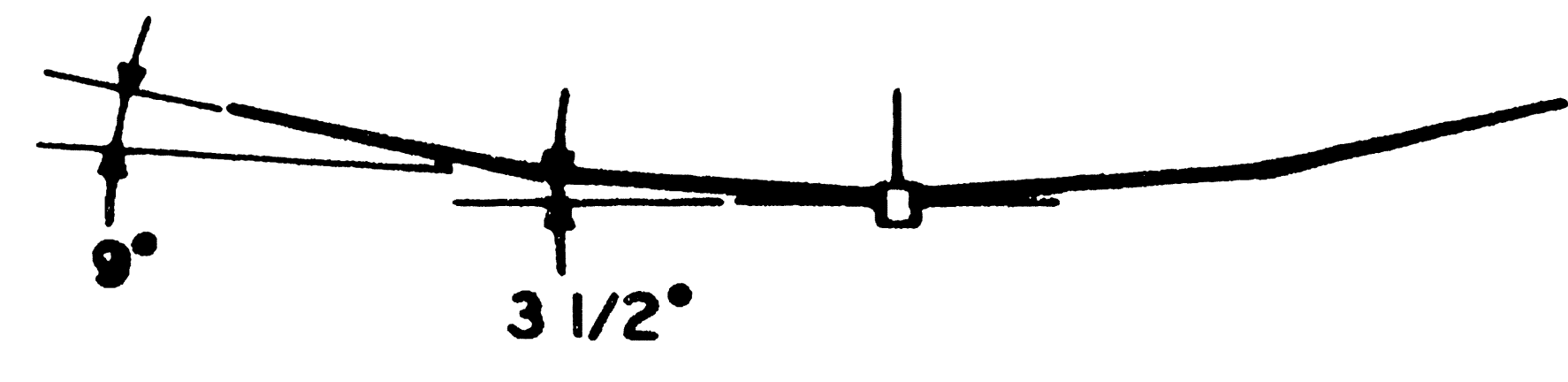
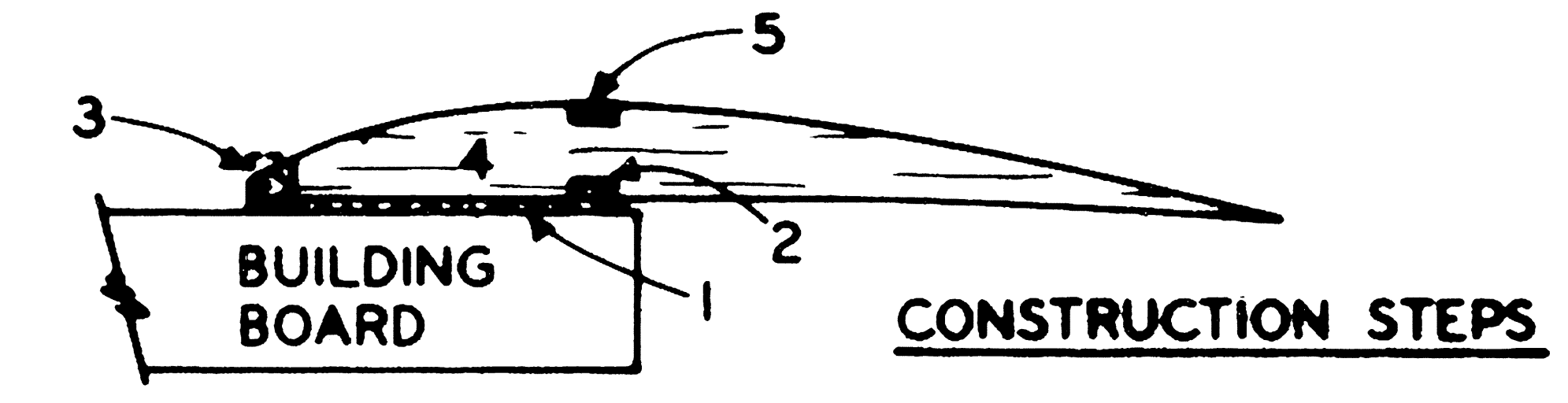

CANOPY COVER 3/8 SHEET

W-2 DRILLED IN CENTER OF RIB
W-1 DRILLED 3/32 HIGHER
W-3 DRILLED 3/32 LOWER

WING WIRES 2 EA. 5/32 x 8 1/4

.045 MUSIC WIRE CONNECTOR
1/8 SQ. FILLER BLOCKS CONTOURED TO FUSELAGE

STAB & RUDDER CONSTRUCTED FROM 1/8 x 1/4 & 1/8 SQ. BALS

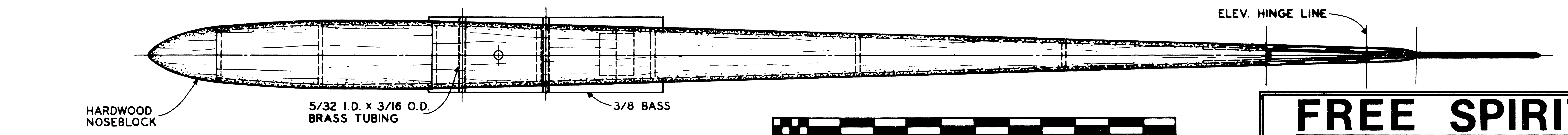

HARDWOOD NOSEBLOCK

5/32 I.D. x 3/16 O.D. BRASS TUBING

3/8 BASS

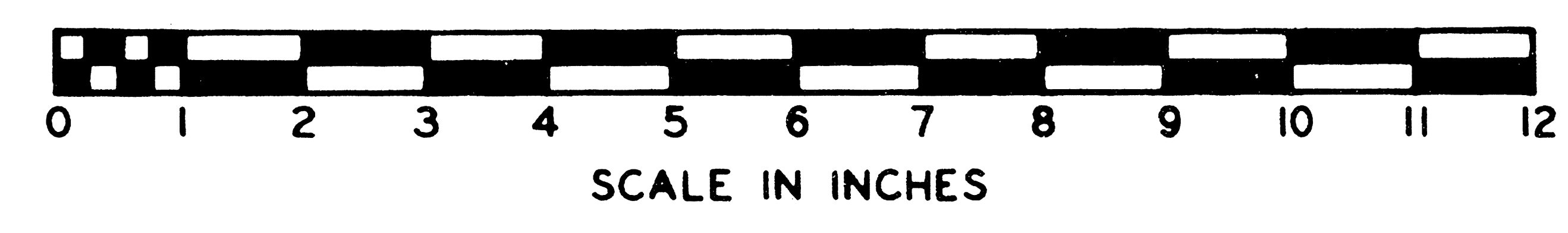

FREE SPIRIT
DESIGNED & DRAWN BY LEON KINCAID
INKED BY LOU WOLGAST

H.E

FULL SIZE PLAN AVAILABLE THROUGH CARSTENS FLYING PLANS

ORDER PLAN CF-565