

K19

Nekatere opombe in korekcije:  
 - ni upoštevan offset 0,1mm za laser  
 - nosilec K14 iz VP ni simetričen  
 - prečniki za trup L12, L13 in L14 ne pašejo - tudi ni potrebno vgraditi  
 - med lepljenjem zgornje oplate krila je potrebno na koncu oplato razcepiti zaradi krivljenja

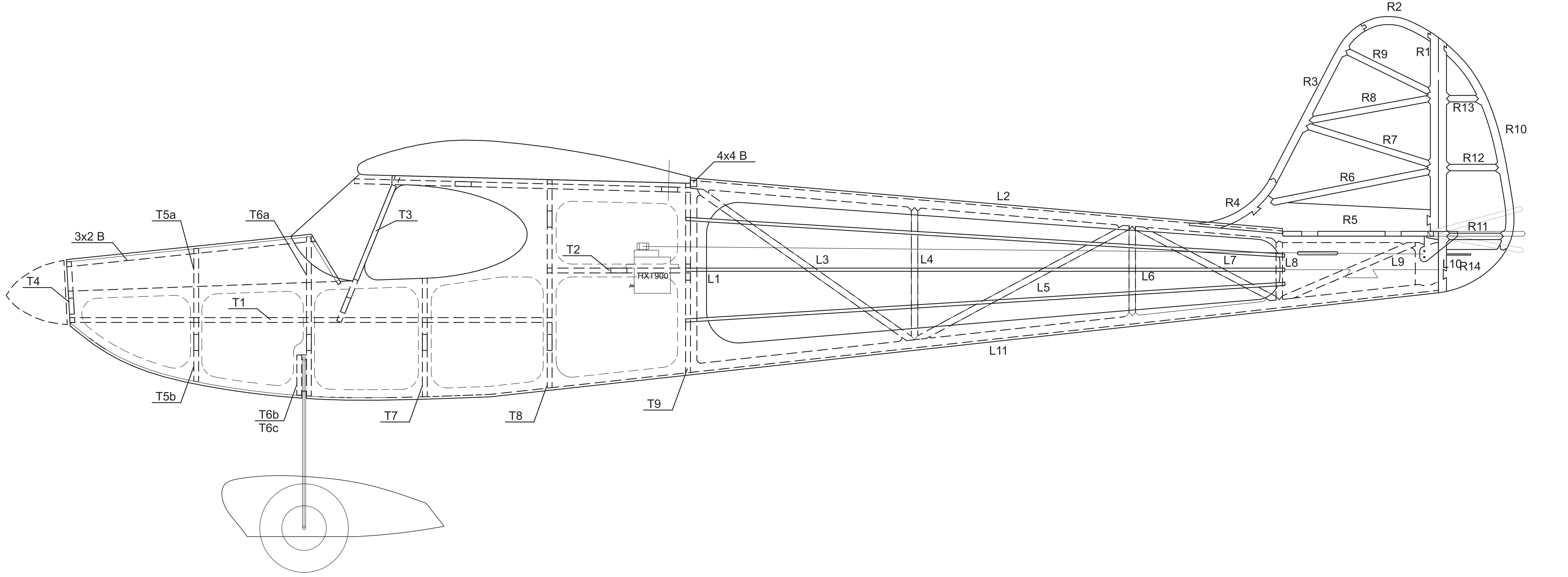

BALSA 1,5mm

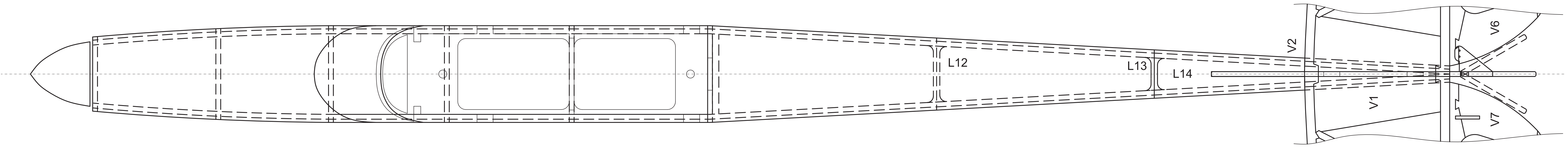
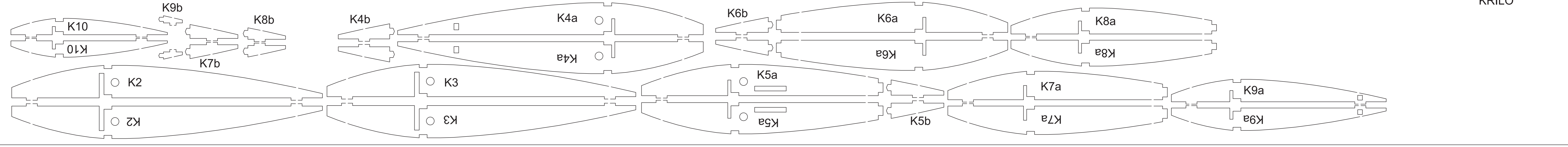
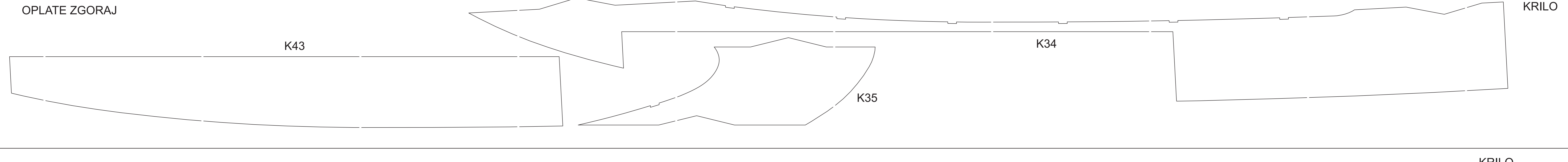
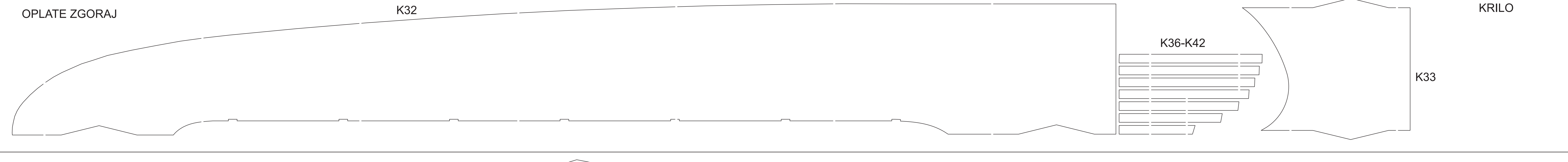
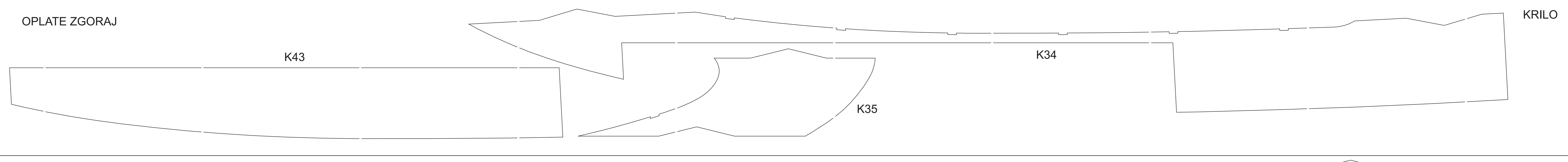
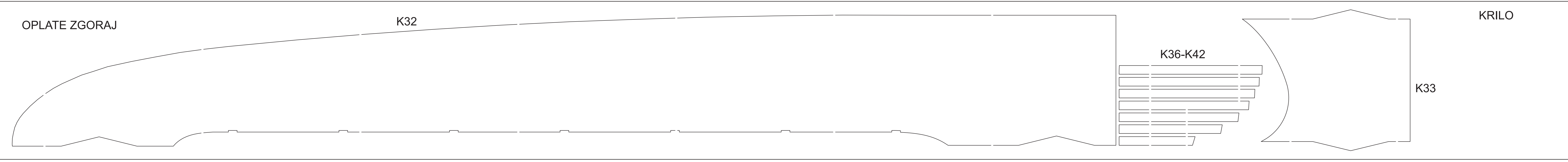
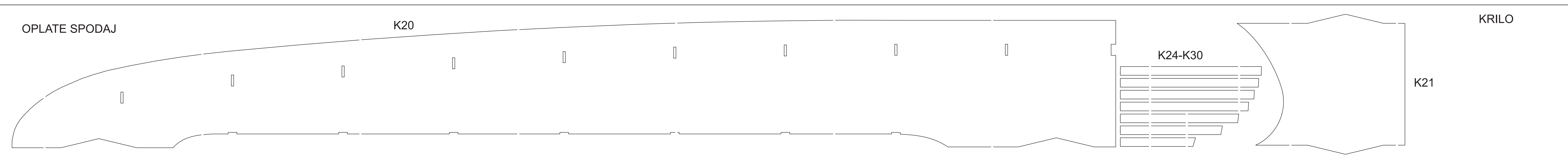
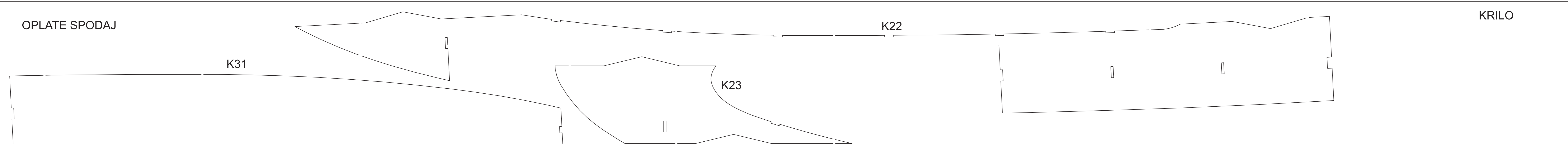
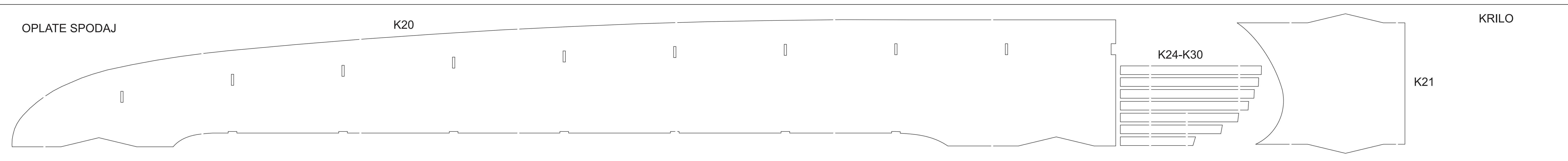
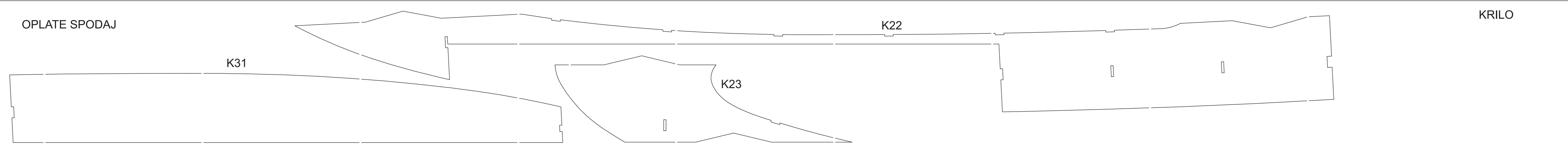

BALSA 2mm

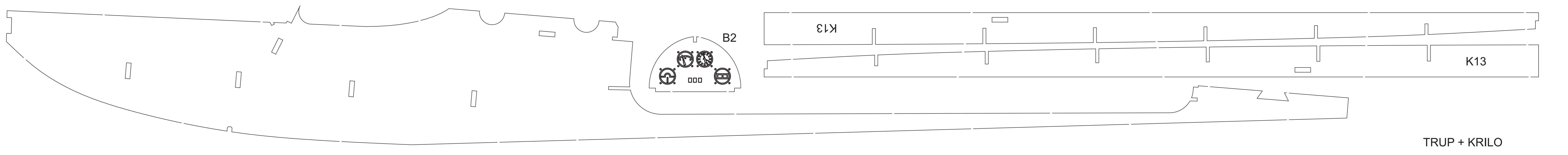
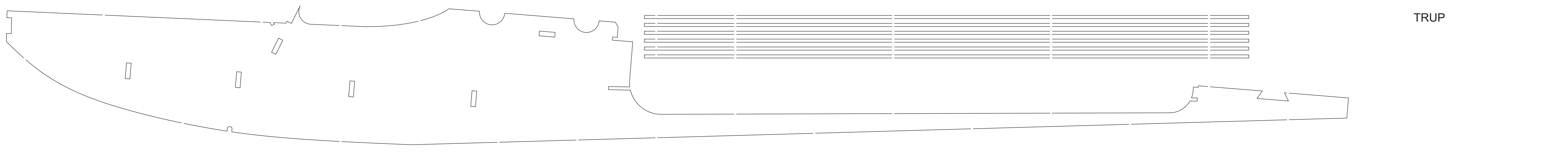
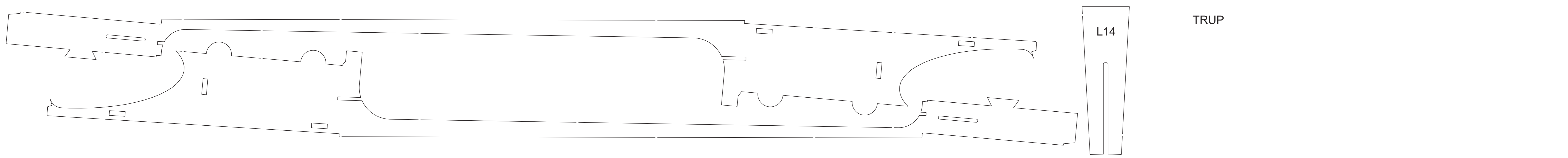

BALSA 3mm

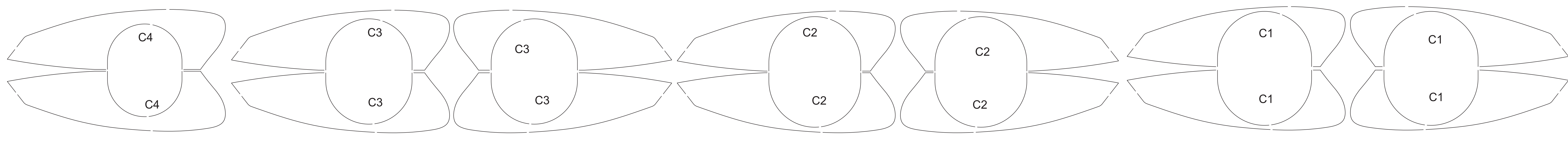
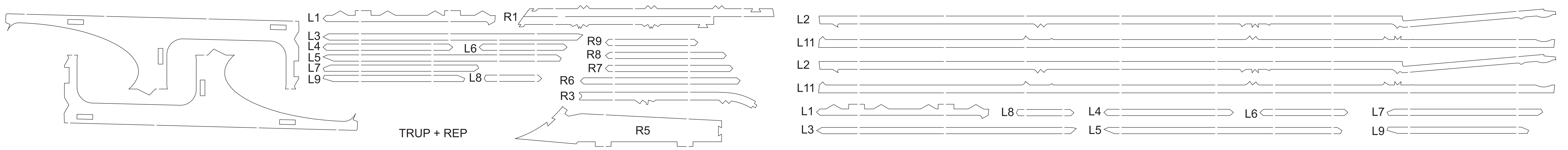
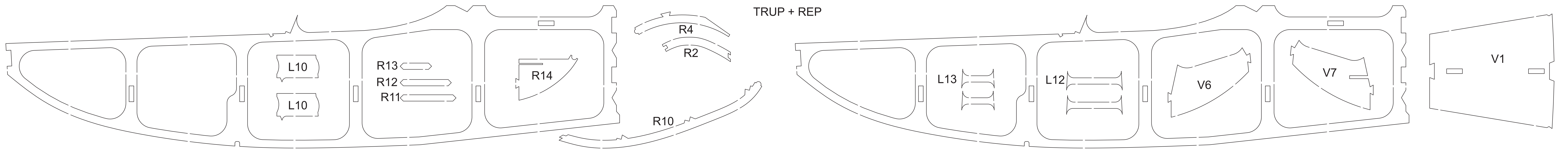
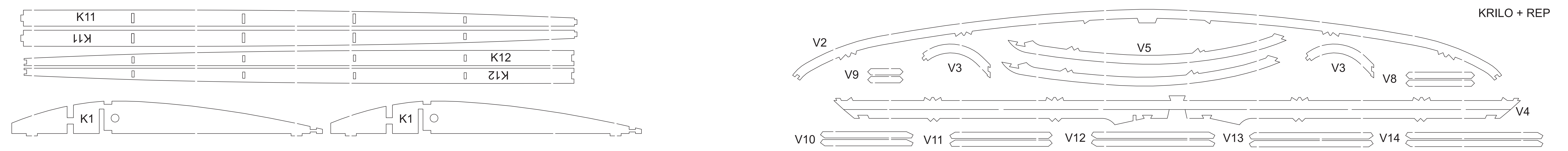
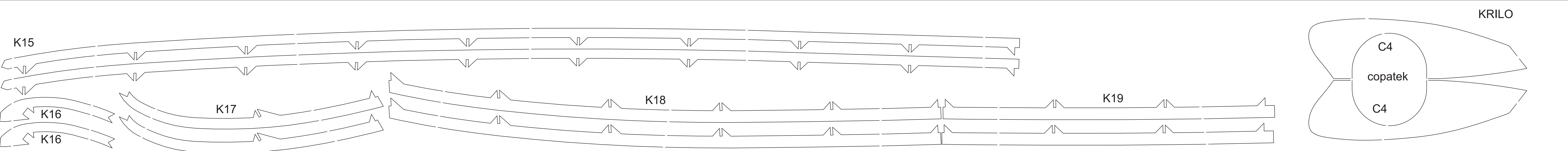

# TOPOL VP 3mm

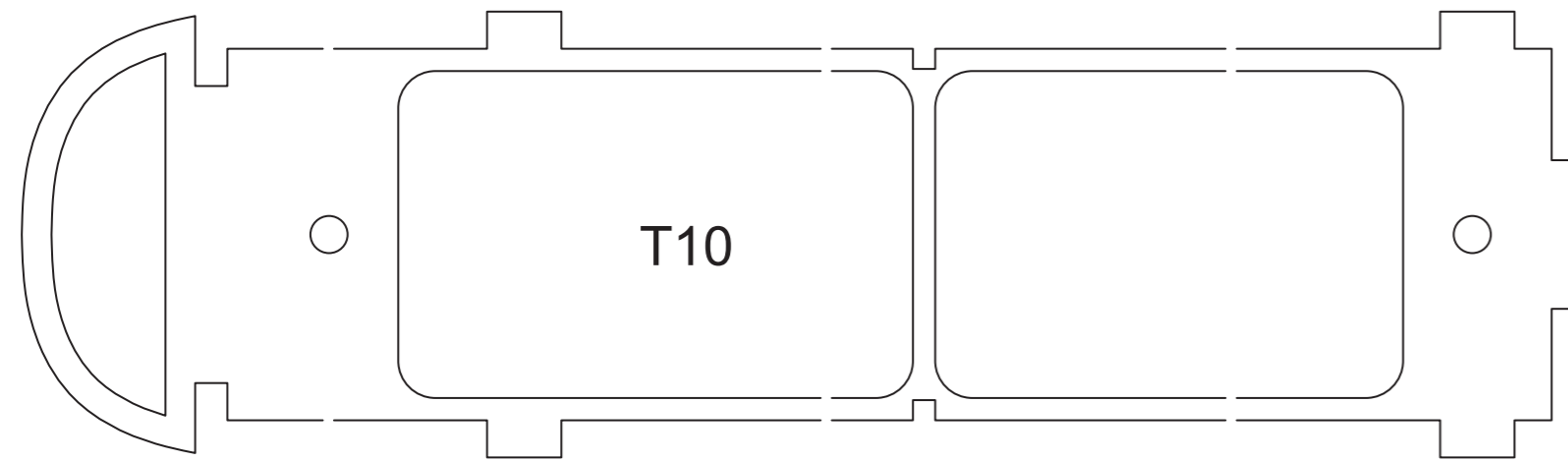

ŠABLONA

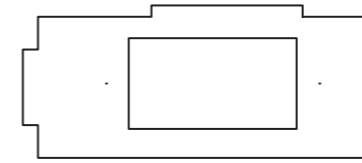
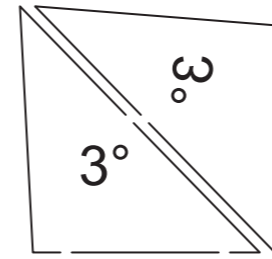

K15

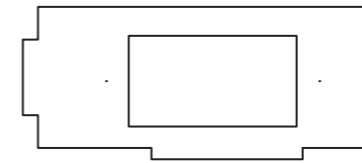

K15

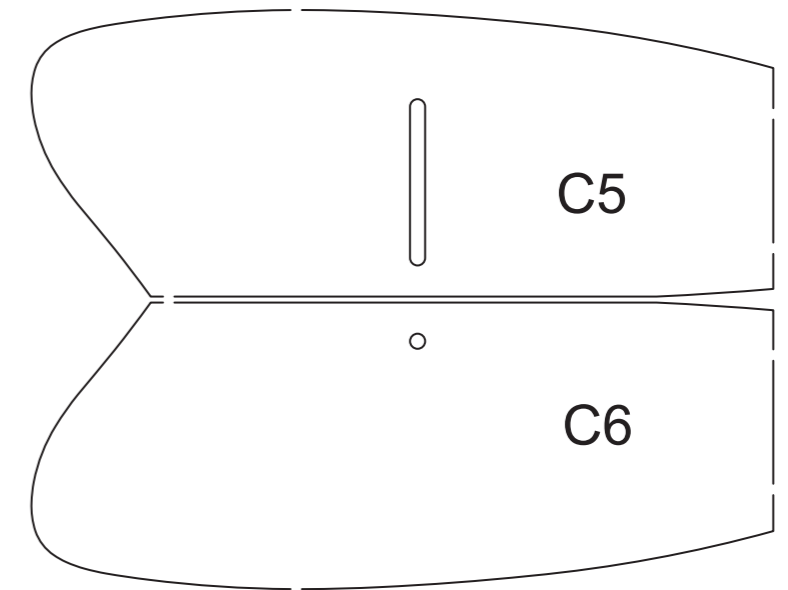

C5

C6

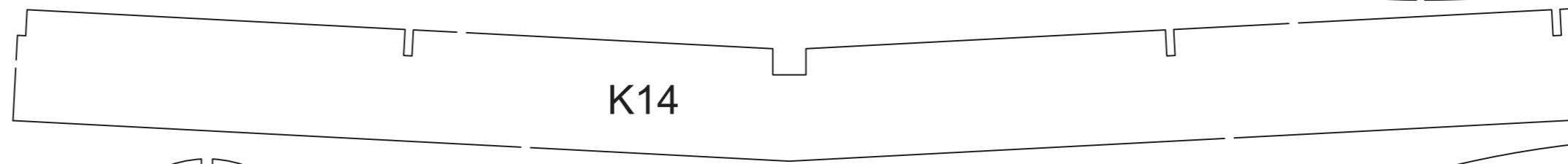

K14

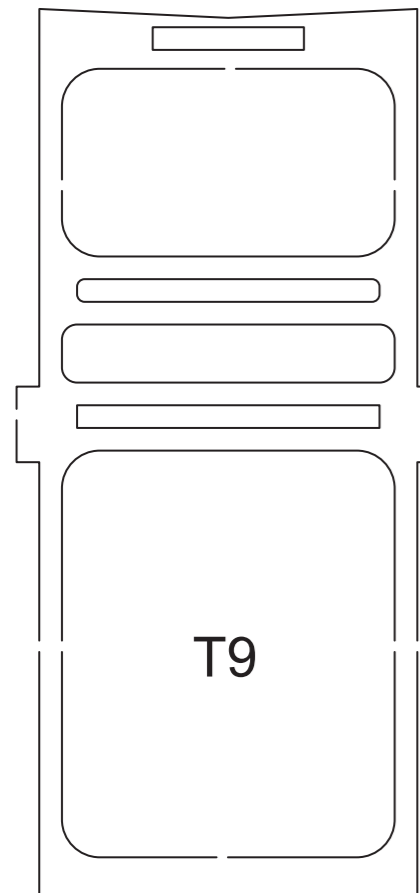

T9

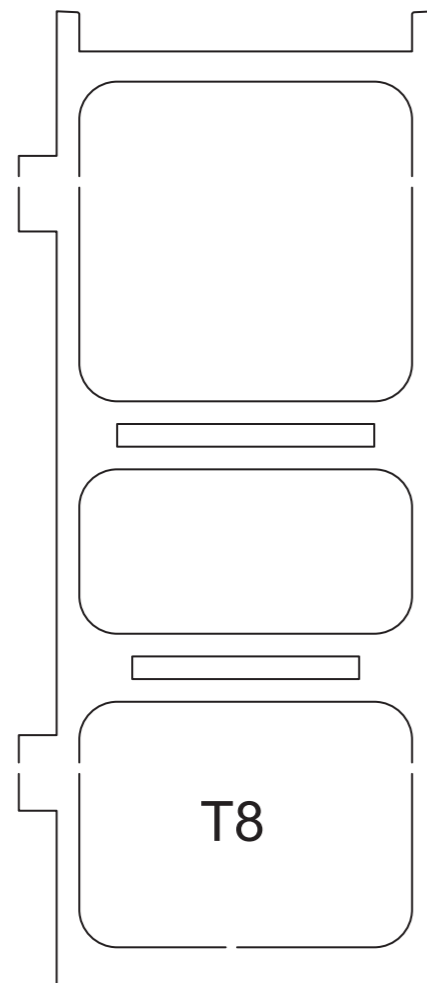

T8

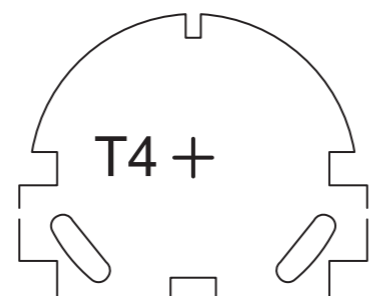

T4 +

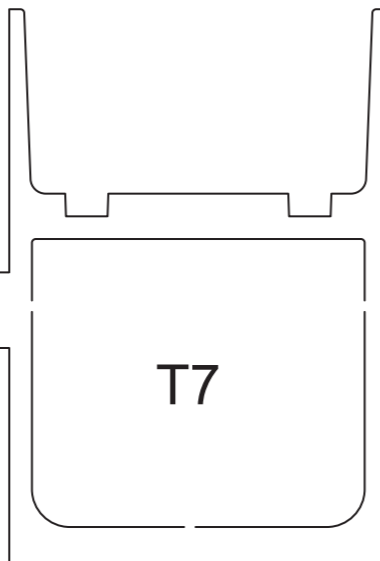

T7

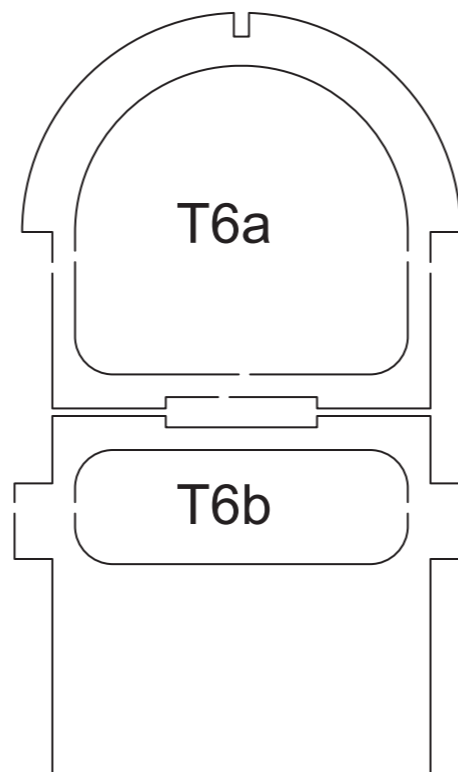

T6a

T6b



K1b

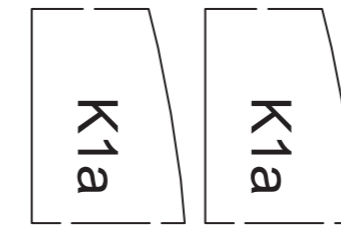

K1a

K1a

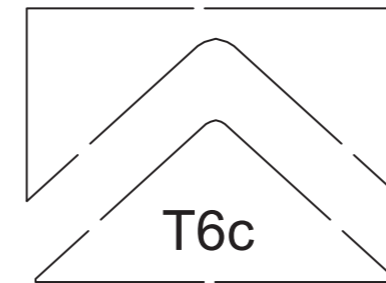

T6c



T6d

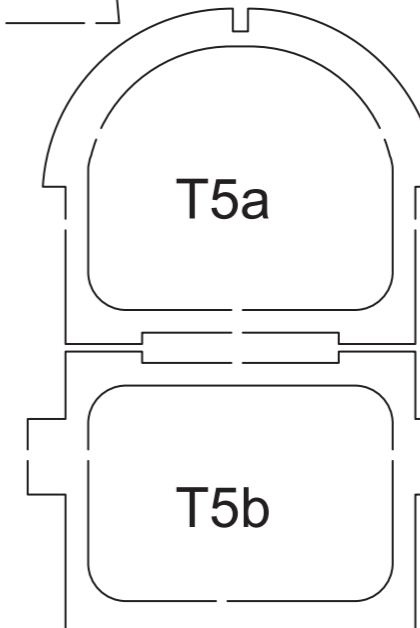

T5a

T5b

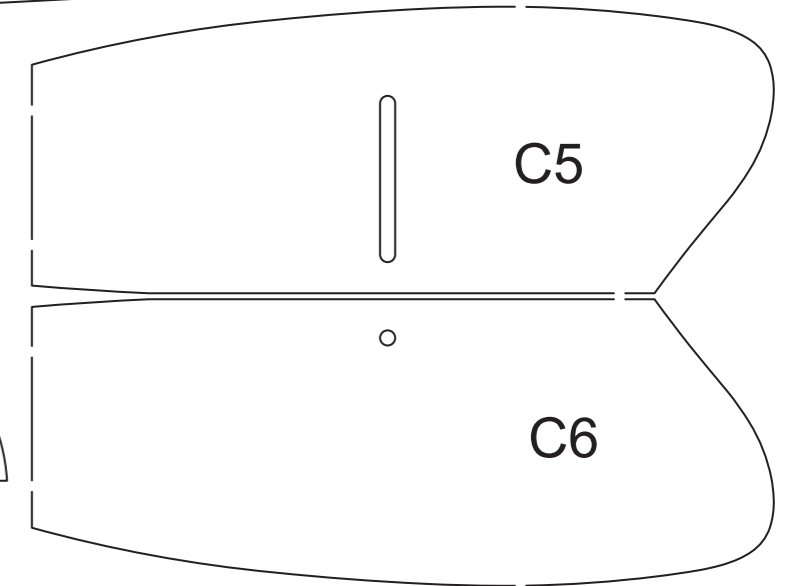

C5

C6

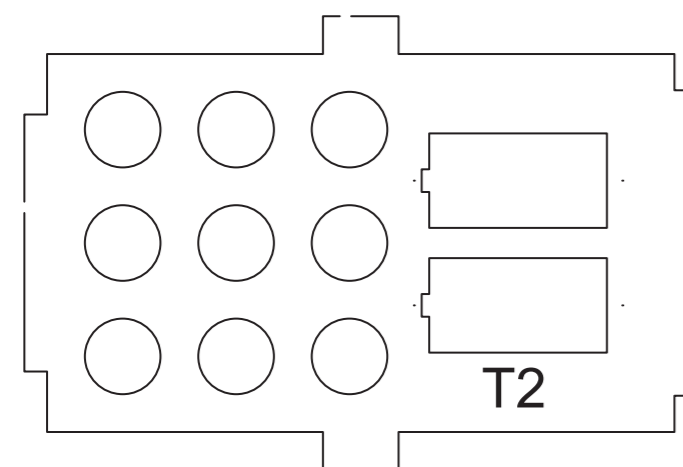

T2



T1

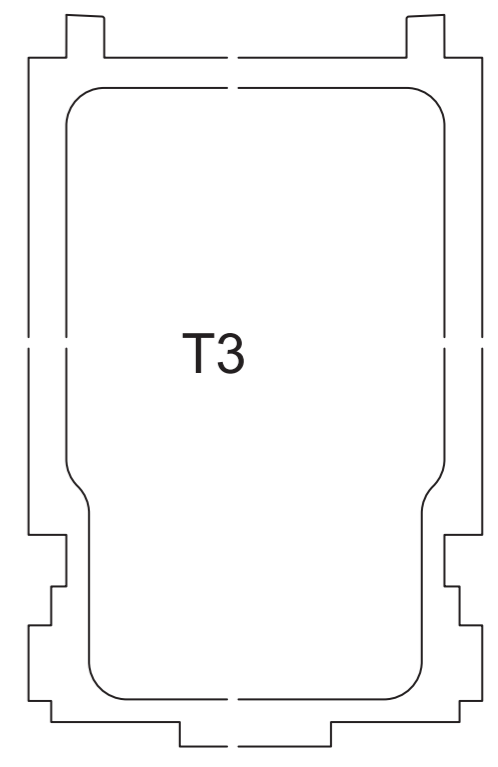

T3