

FUSELAGE DETAILS - CLODHOPPER II

# WING & TAIL SURFACES

RIBS 1 1/2 APART

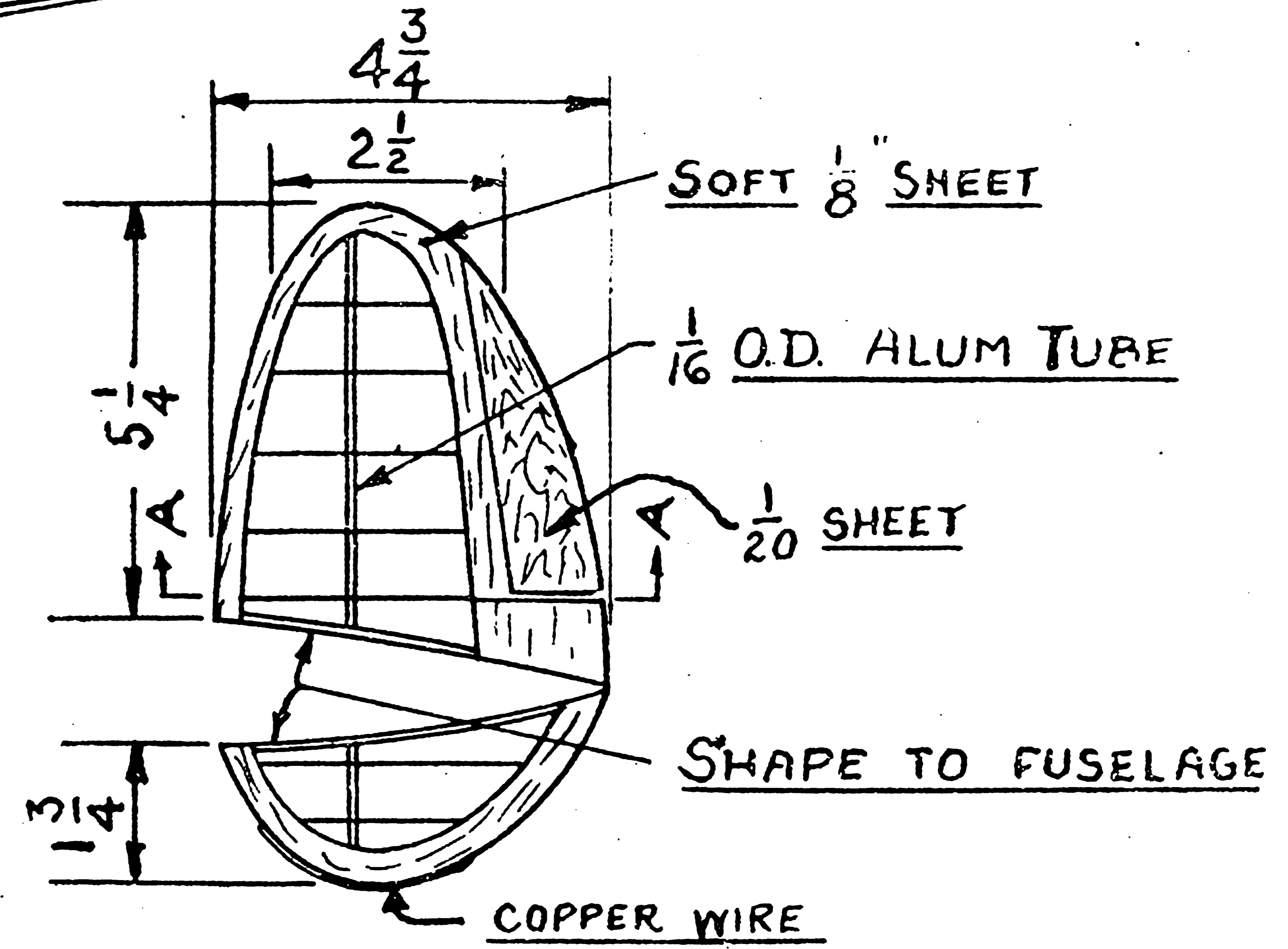

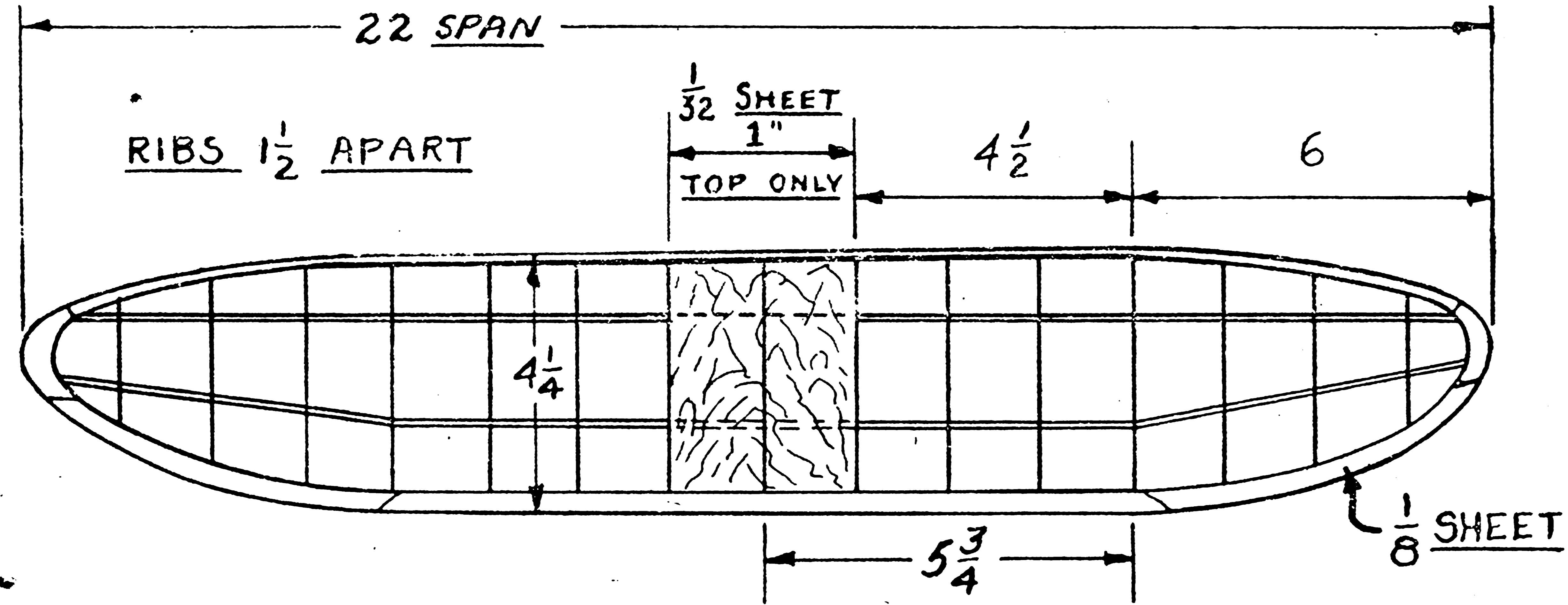
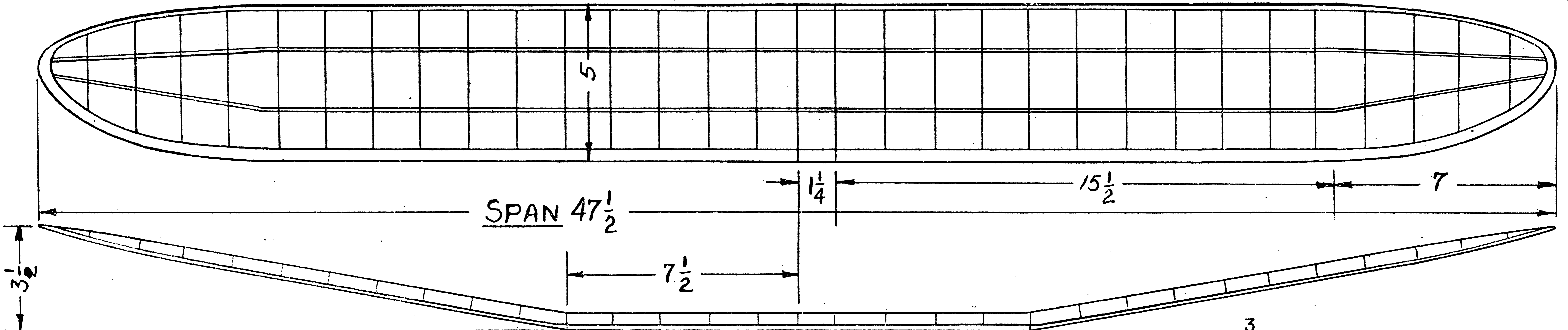
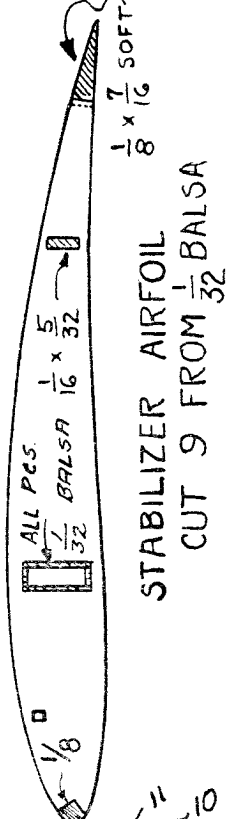

STABILIZER AIRFOIL  
 CUT 9 FROM  $\frac{1}{32}$  BALSA



TIP RIB OF WING

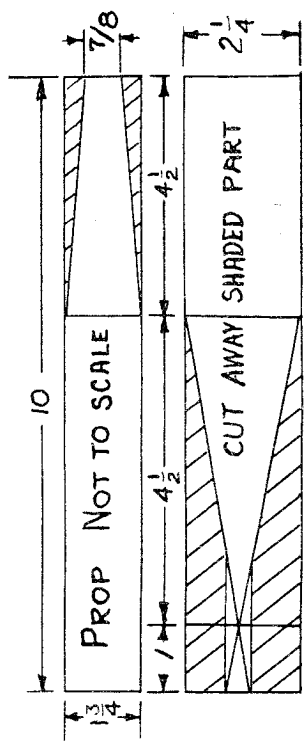

SECTION A-A OF RUDDER

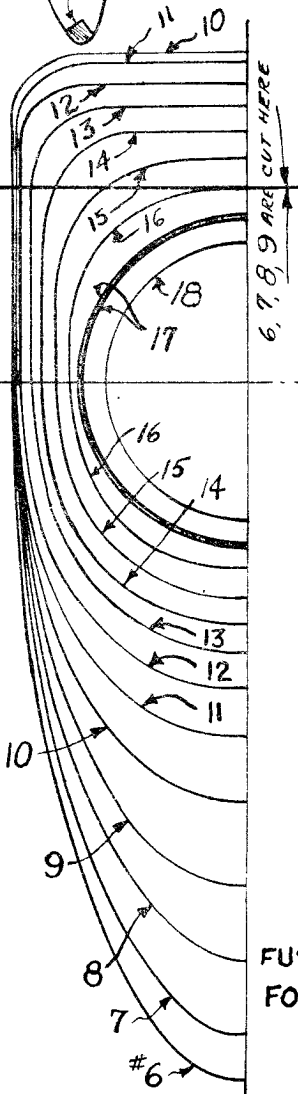

FUSELAGE FORMERS

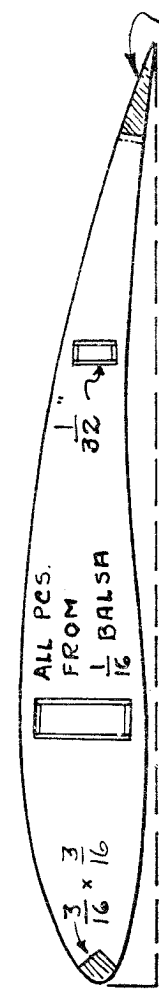
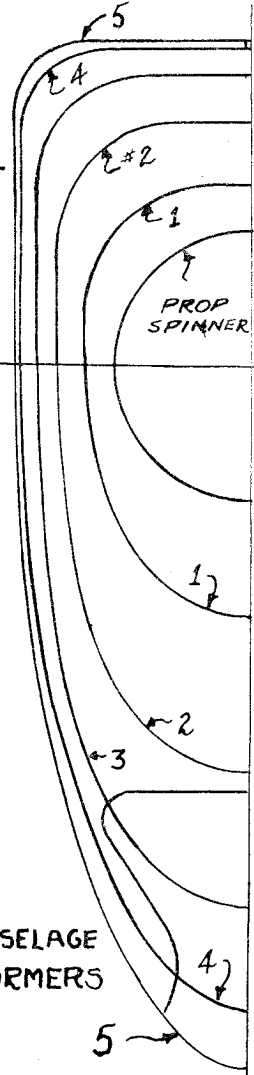

WING AIRFOIL  
 CUT 23 FROM  $\frac{1}{20}$  BALSA

# ONE BLADE PROP

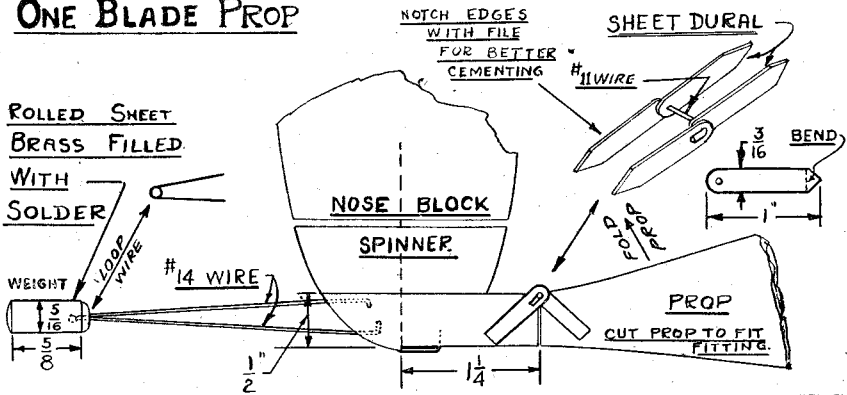

The 1937 winner sported a feathering, one-blade prop.

## THREE VIEWS OF NOSING

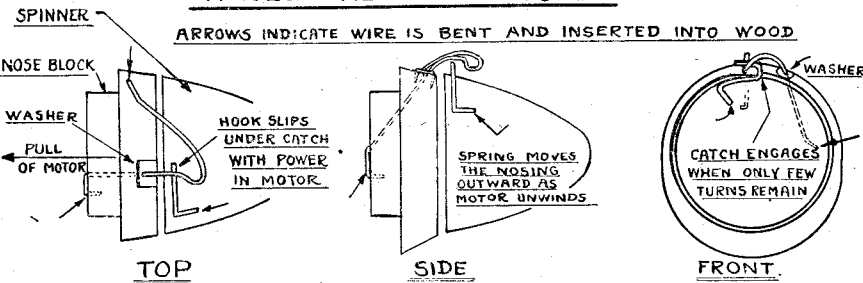

Below: Because of the tensioner, the rear fuselage section stays attached without hooks, etc.

## REAR FUSELAGE

