

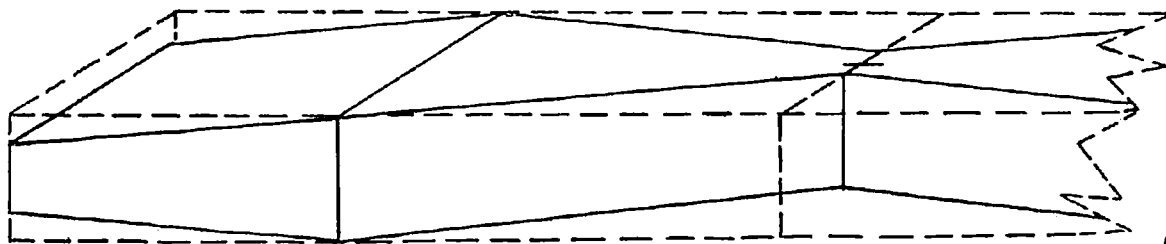

TYPICAL TAIL SECTION

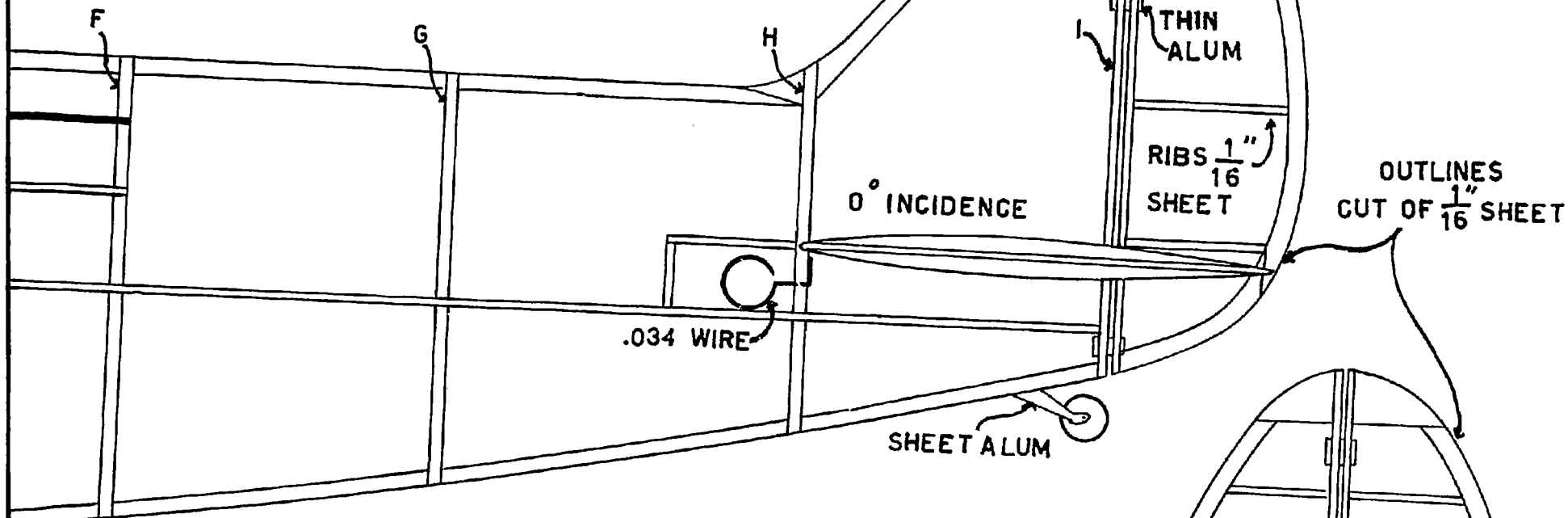

PROPELLER BLOCK $8 \times 1 \times \frac{5}{8}$

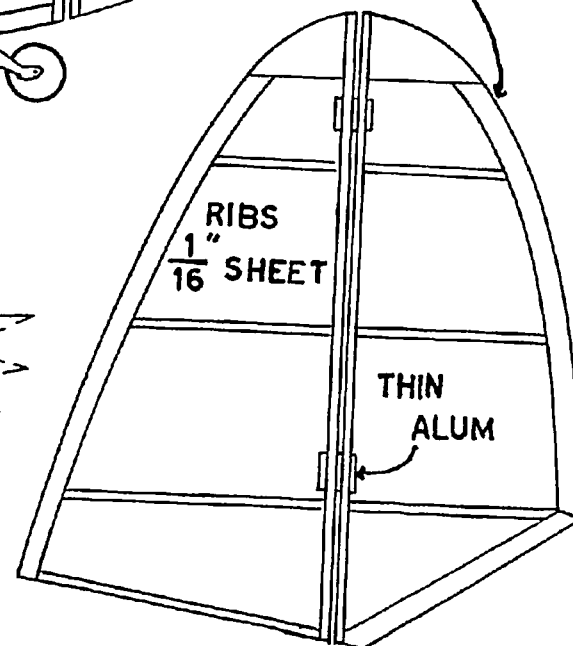

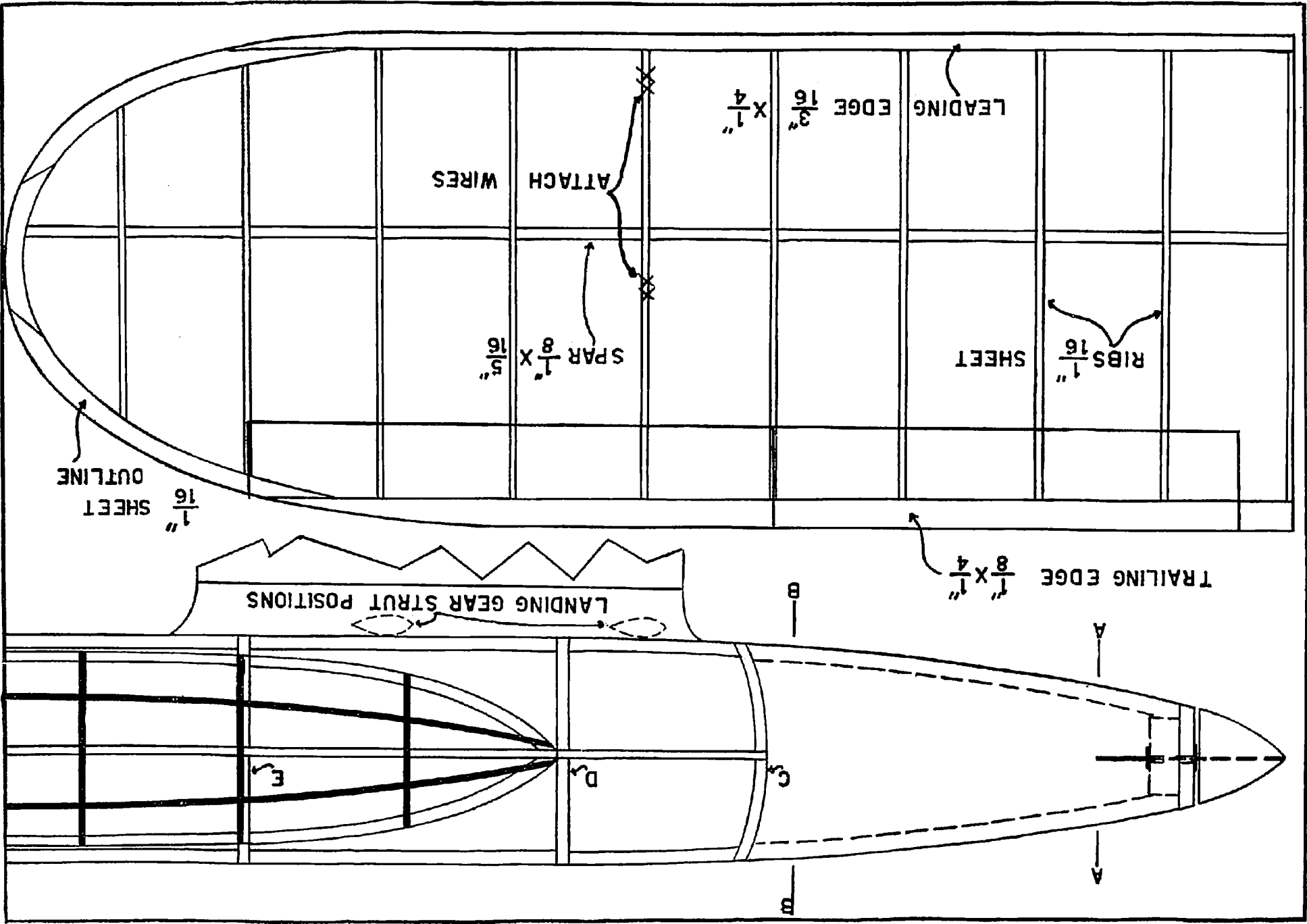

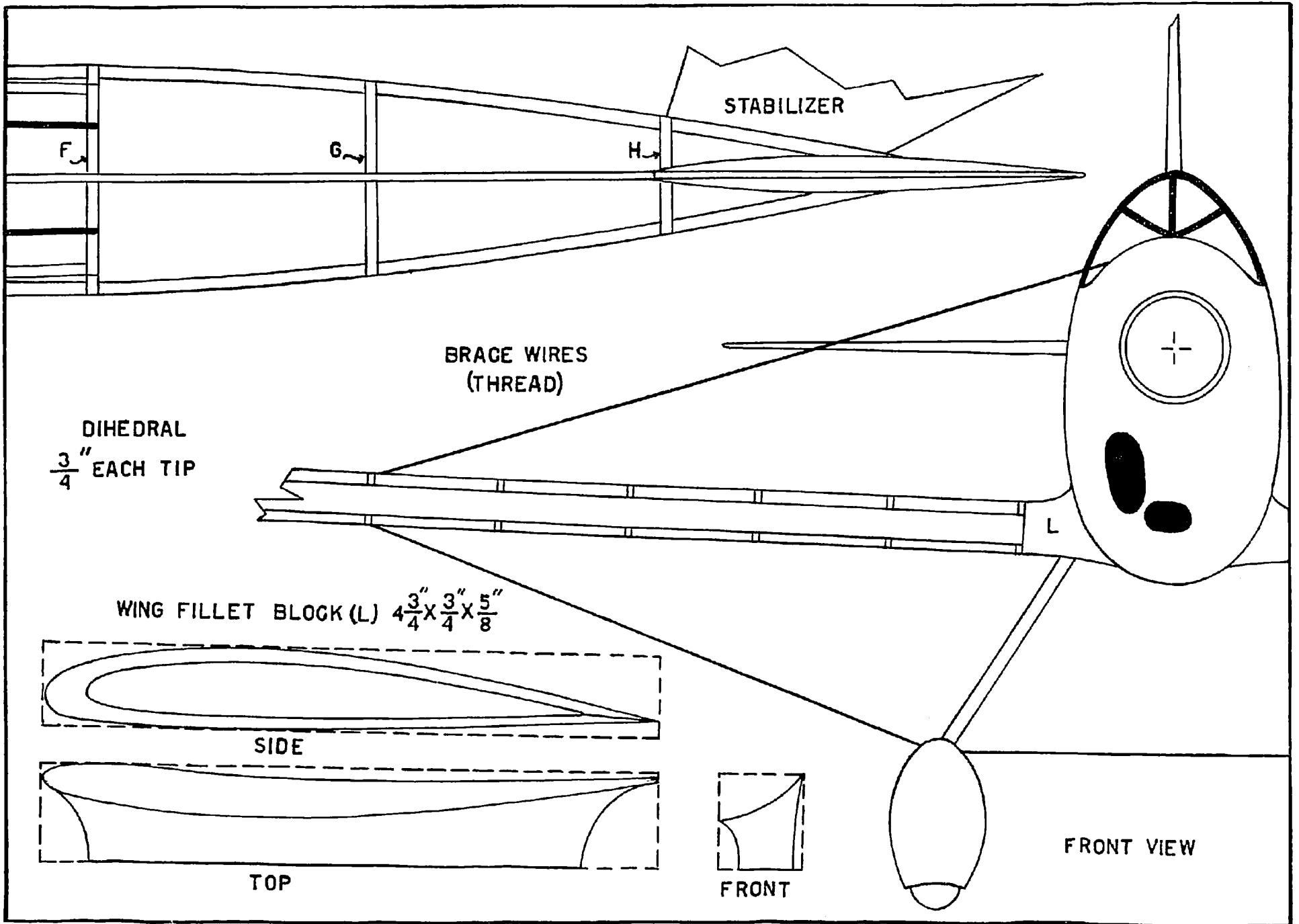

ALL AUXILIARY STRINGERS $\frac{1}{16}$ " SQ

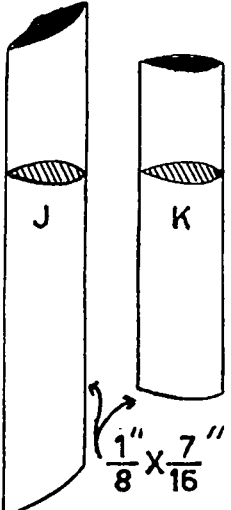
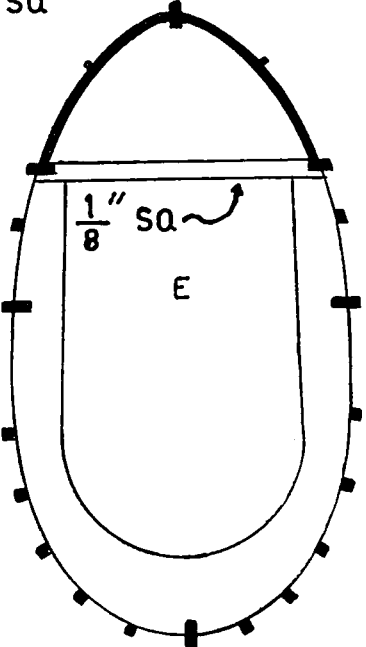
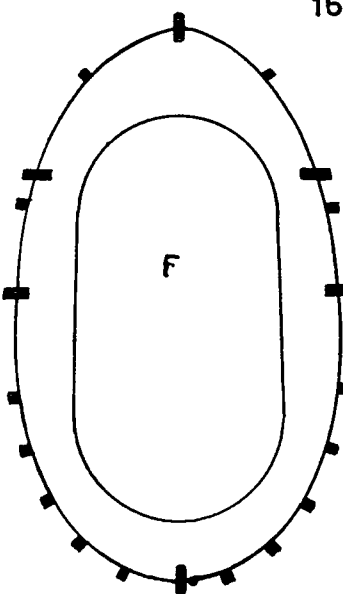
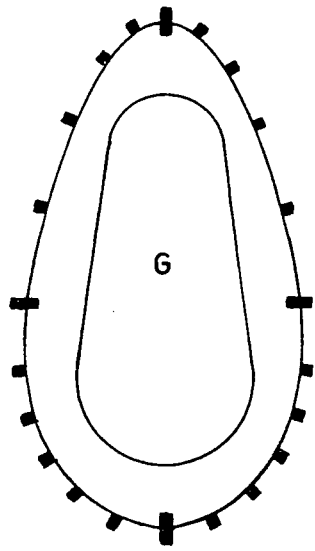

LANDING GEAR STRUTS

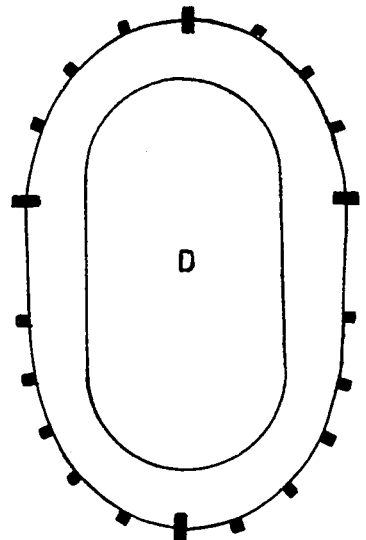
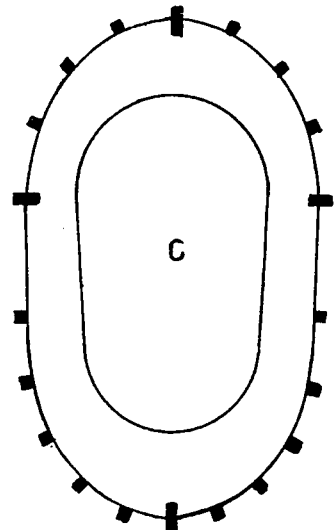
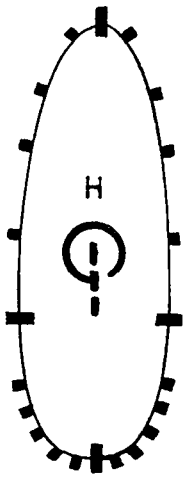

ALL FORMERS $\frac{1}{8}$ " SHEET



RIB 1, 16



RIB 3, 2



RIB 2, 2

ALL RIBS $\frac{1}{16}$ " SHEET

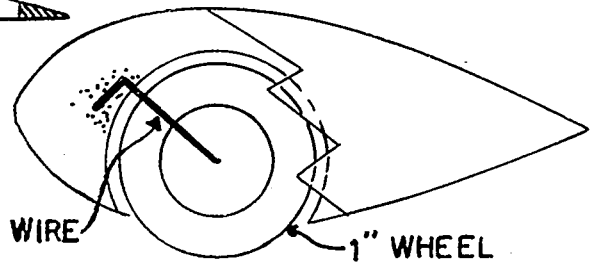

.034 WIRE

1" WHEEL

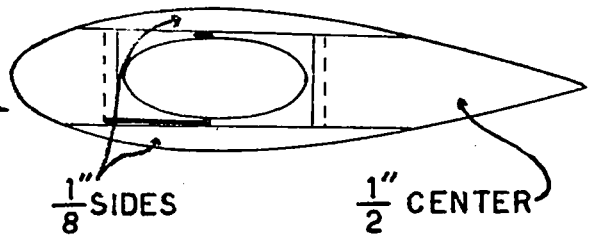

$\frac{1}{8}$ " SIDES

$\frac{1}{2}$ " CENTER