

SCALE PROP
WHITE PINE (OPTIONAL)

PROPELLERS

PROP-FLYING
BALSA

PLATE--II

rt. hand PROPS

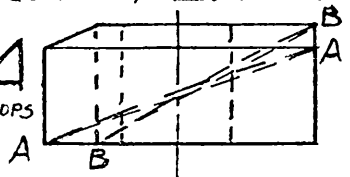

END VIEW

SCALE --- FULL SIZE

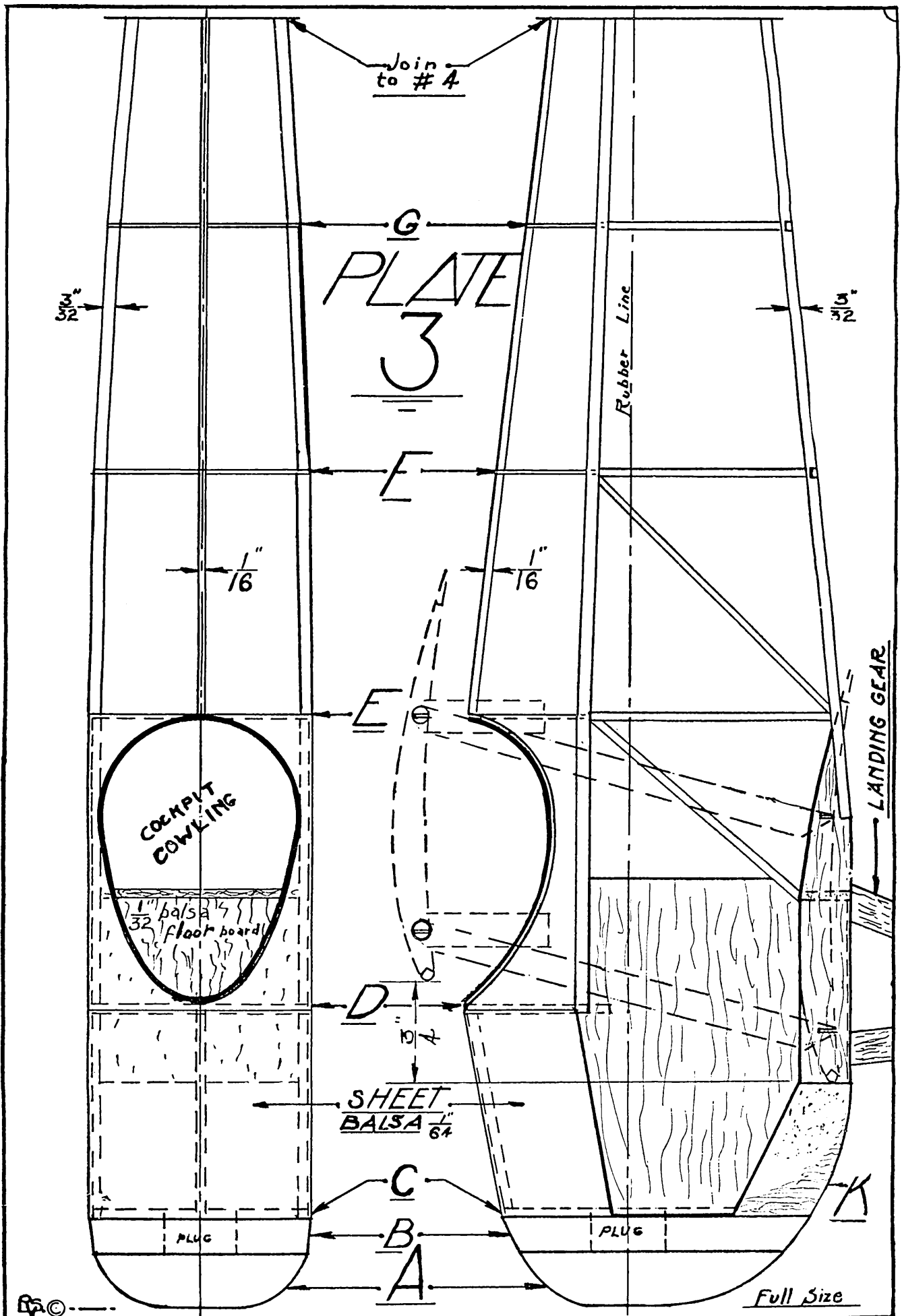

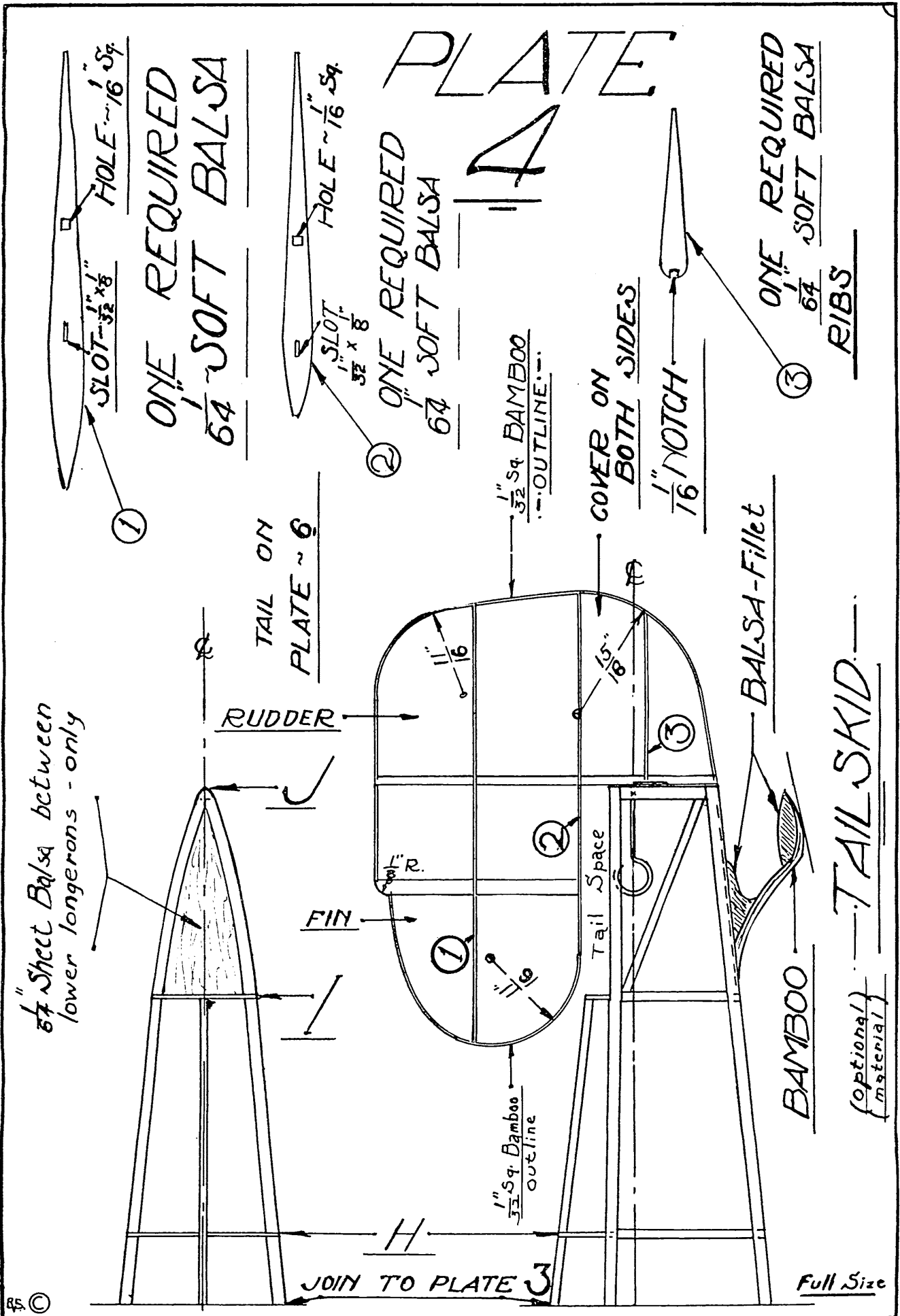

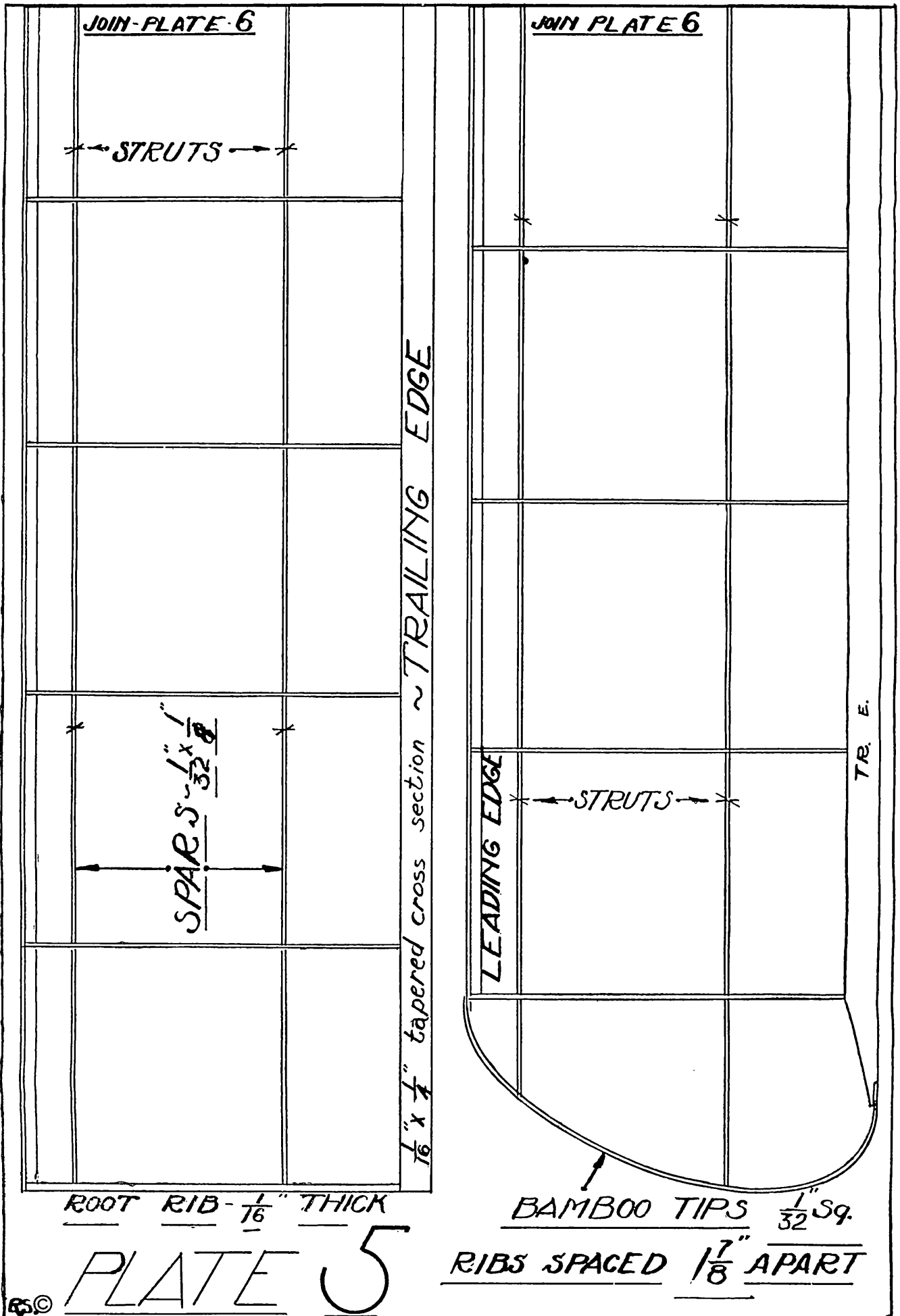

©

PLATE 6

FULL SIZE

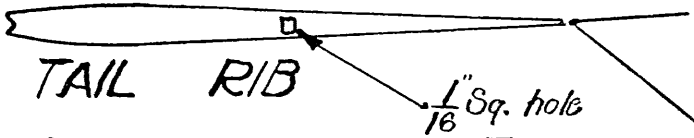

TAIL RIB
 FOUR REQUIRED
 $\frac{1}{64}$ " SOFT BALSA

ROUNDED EDGE

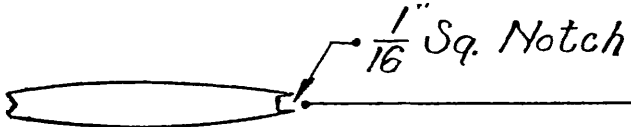

CENTER TAIL RIB
 ONLY ONE REQUIRED
 $\frac{1}{32}$ " SOFT BALSA

LEADING EDGE

$\frac{1}{16}$ " Sq. X 5" Long

BAMBOO OUTLINE
 $\frac{1}{32}$ " SQUARE

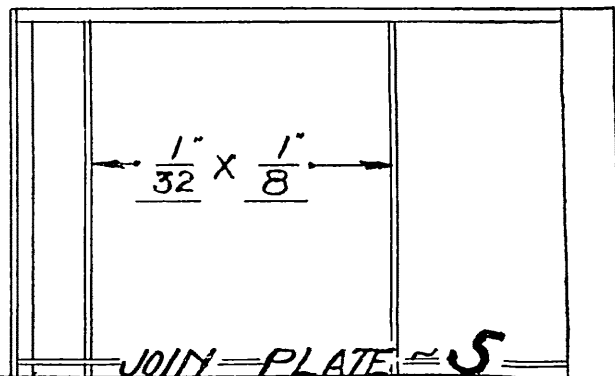
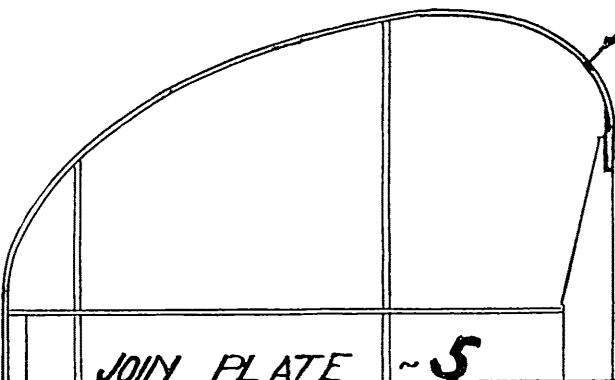
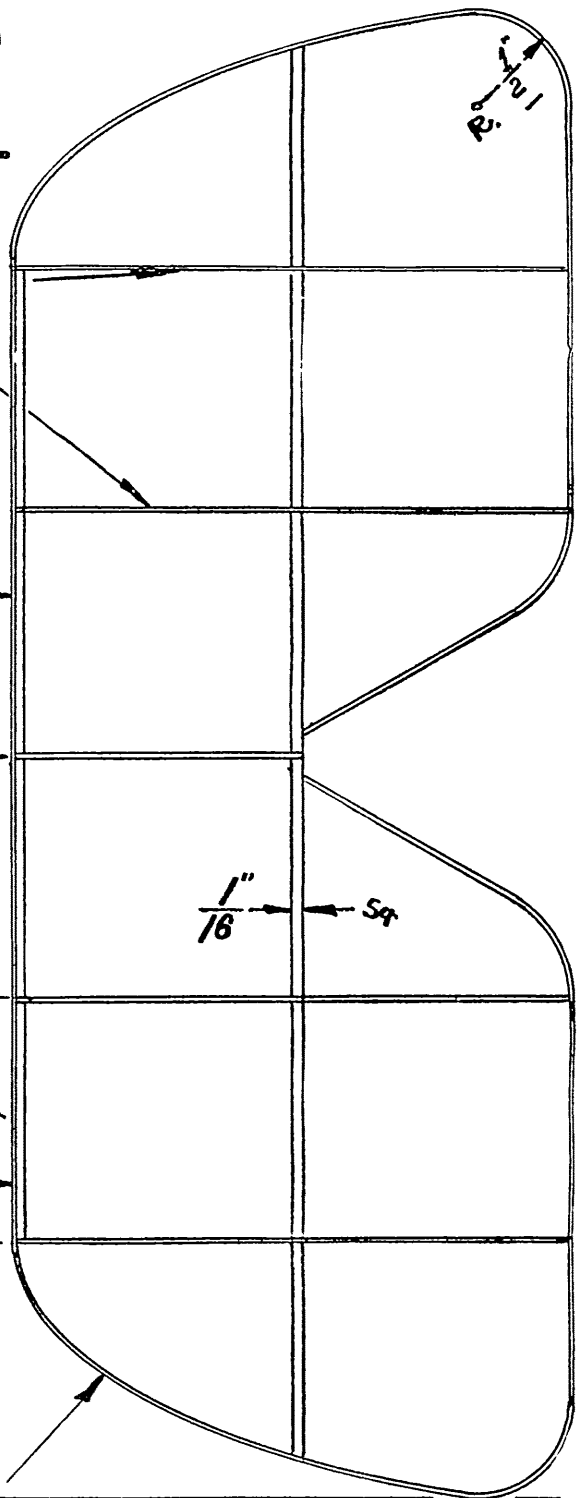

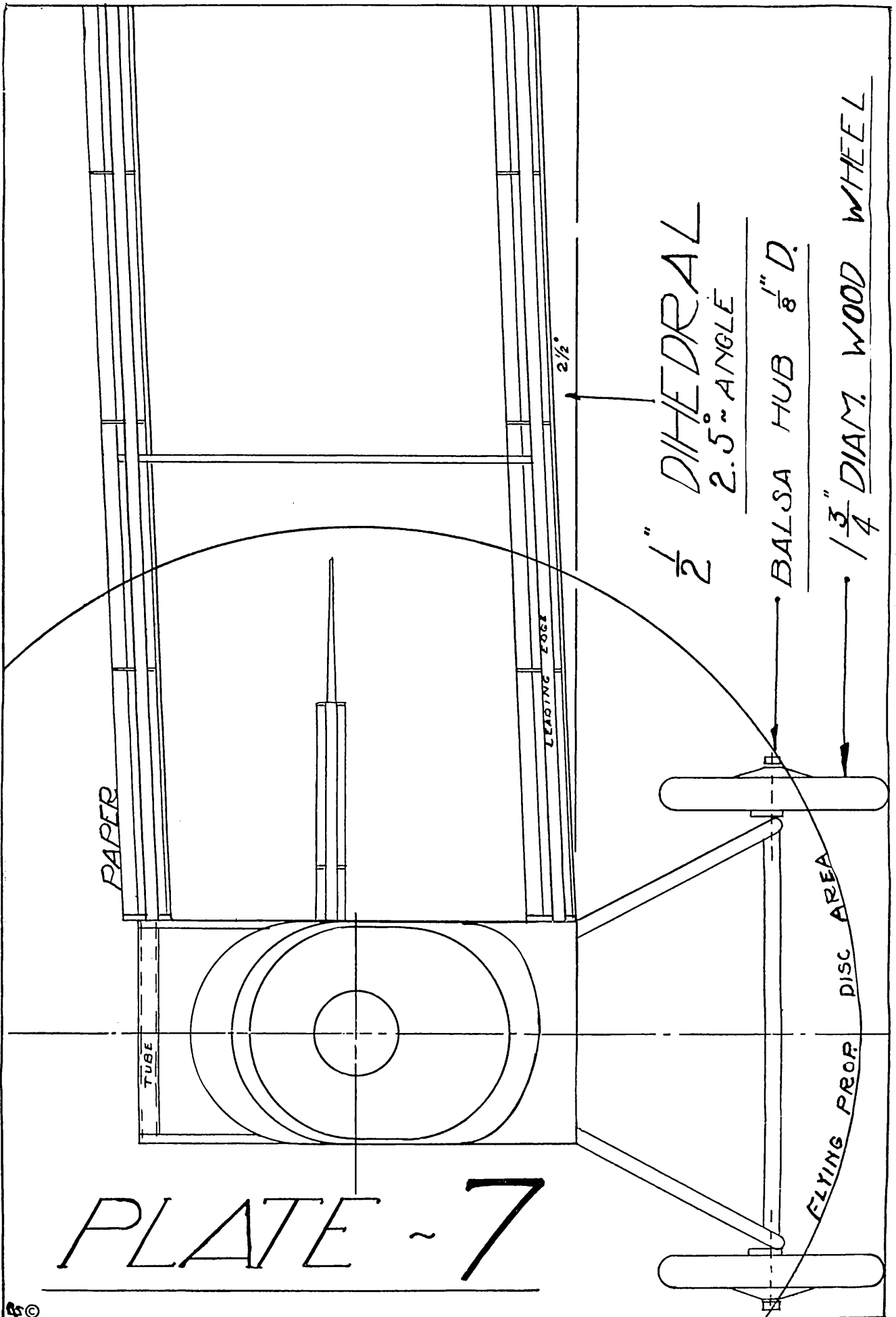

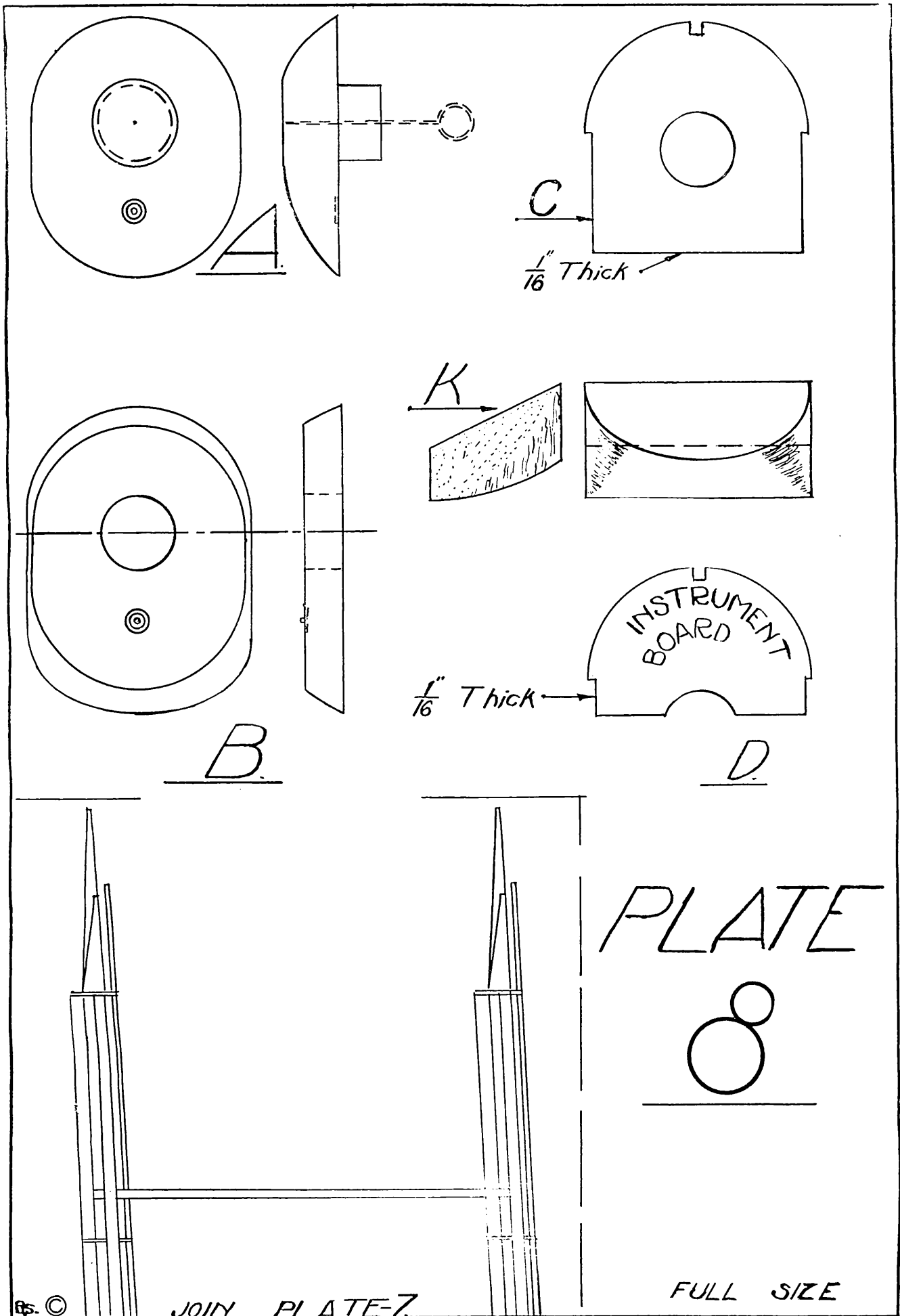
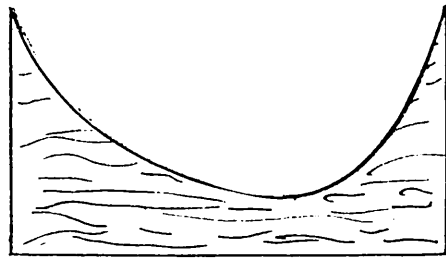
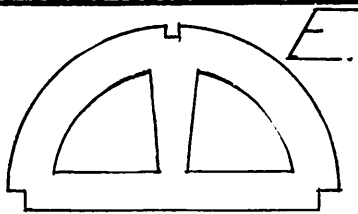
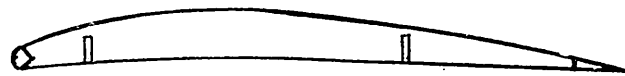
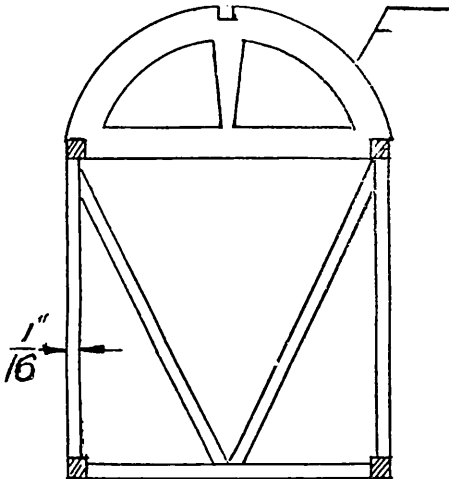

PLATE 9



COCKPIT
COWLING
 $\frac{1}{64}$ Balsa



WING RIB - 24 Needed

WING STRUTS
8 REQUIRED

$\frac{1}{16} \times \frac{3}{16}$ Balsa

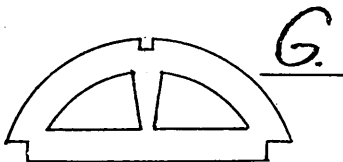

S HOOK

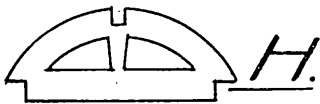

SHORT STRUT
- 4 REQUIRED
 $\frac{1}{16} \times \frac{1}{4}$ Balsa

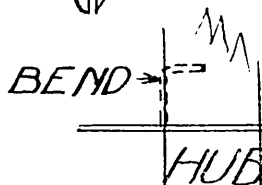
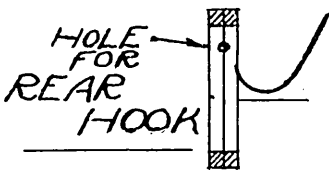
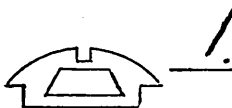

PROP. SHAFT

REAR HOOK

$\frac{1}{4}$ WIRE
(.033)



AXLE

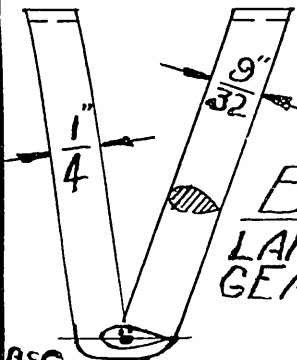

Balsa
LANDING
GEAR

FULL SIZE

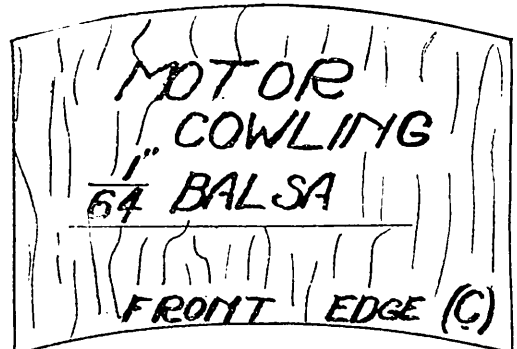

MOTOR
COWLING
 $\frac{1}{64}$ Balsa

FRONT EDGE (C)