

Wiring diagram

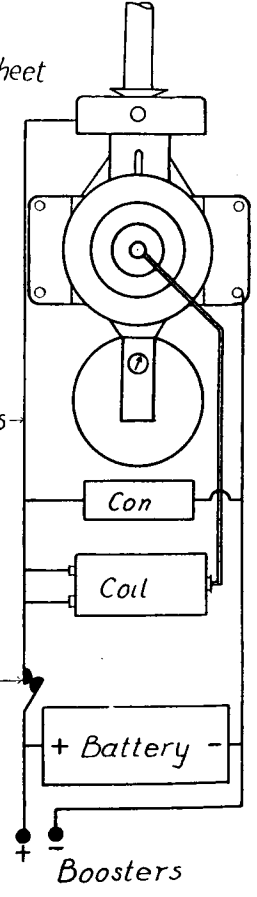

THE POWERHOUSE
 Designed by ~ Sal Taibi
 Drawn by ~ Gordon Murray

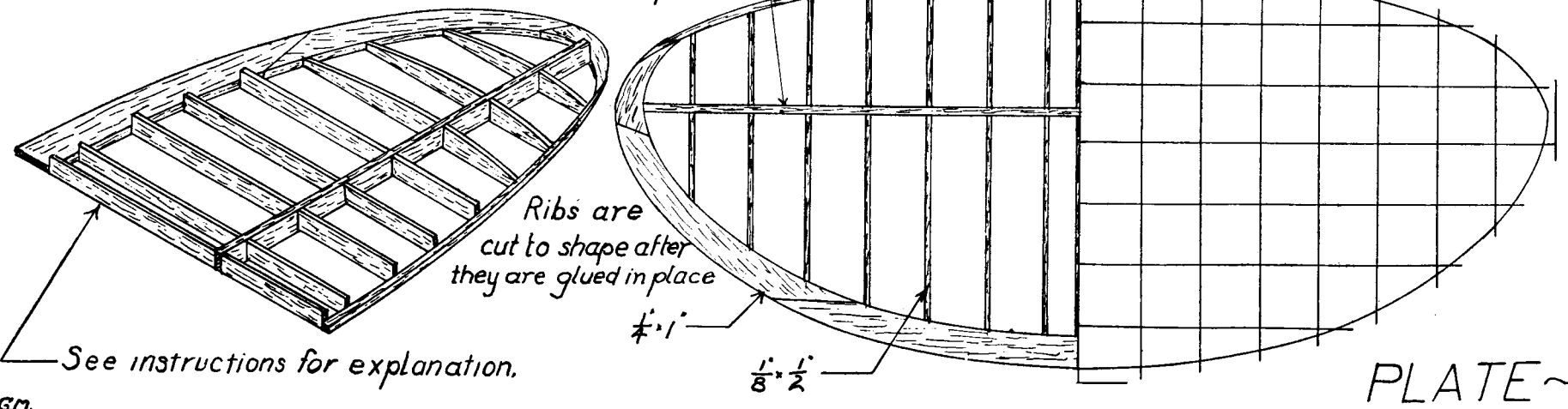
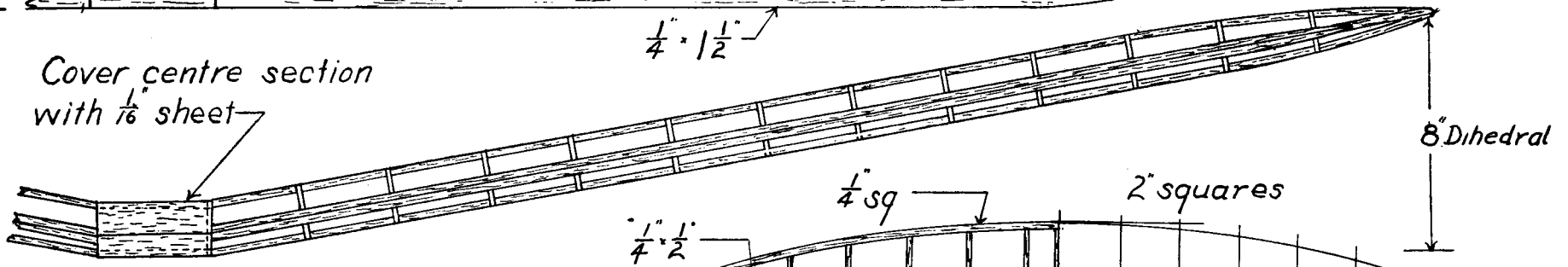
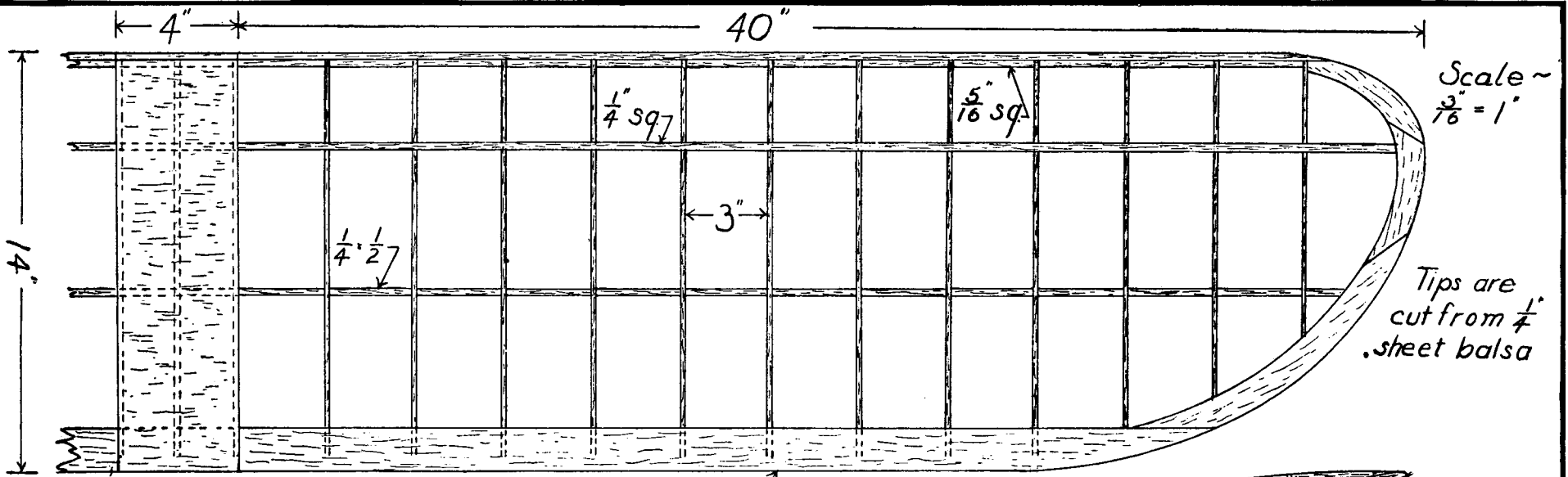

Cut all ribs from $\frac{1}{8}$ sheet balsa.

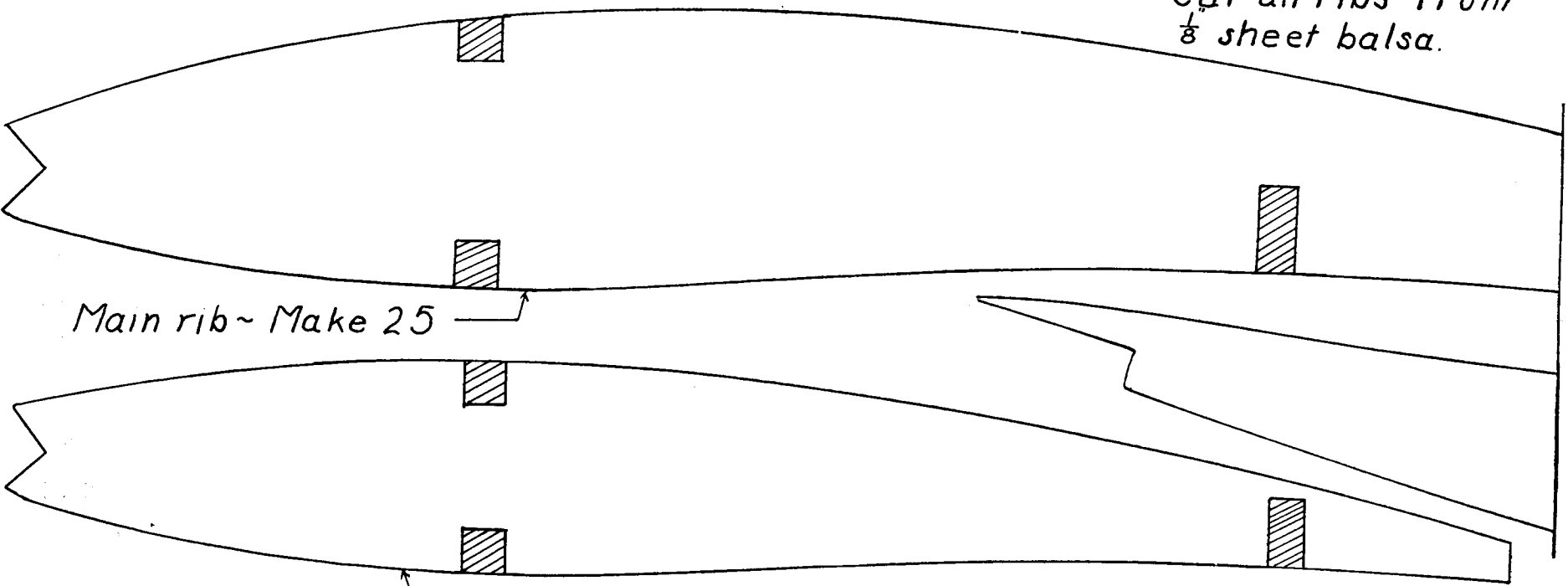

Main rib ~ Make 25

Tip rib ~ Make 2

L.E.

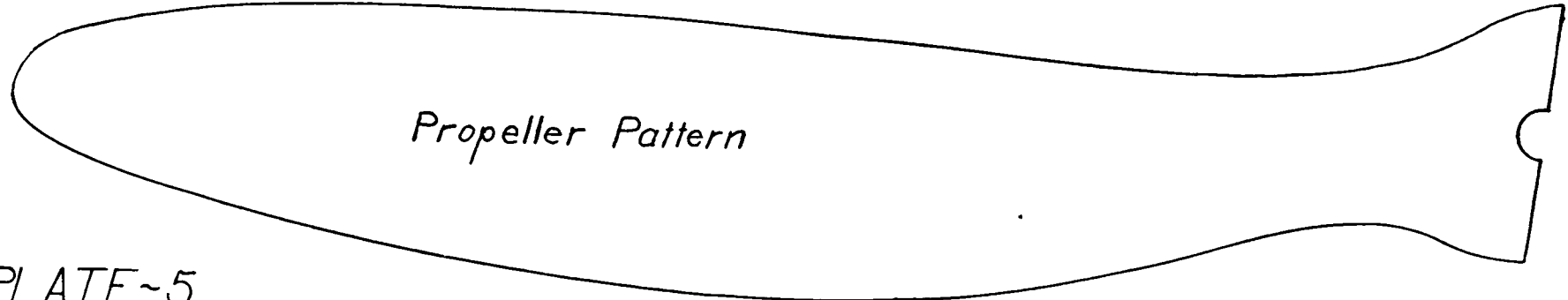
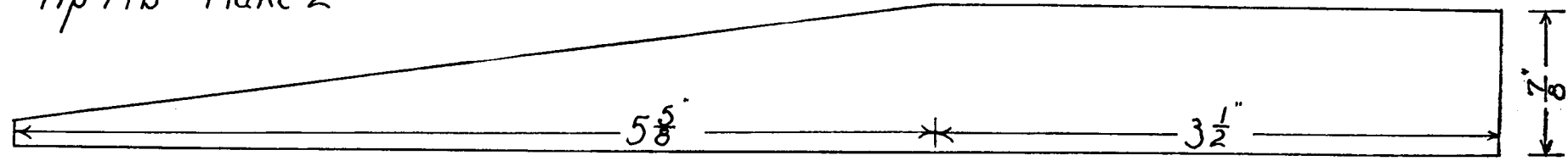

Propeller Pattern

PLATE ~ 2

Cowl ~ Make two
from $\frac{1}{16}$ " sheet

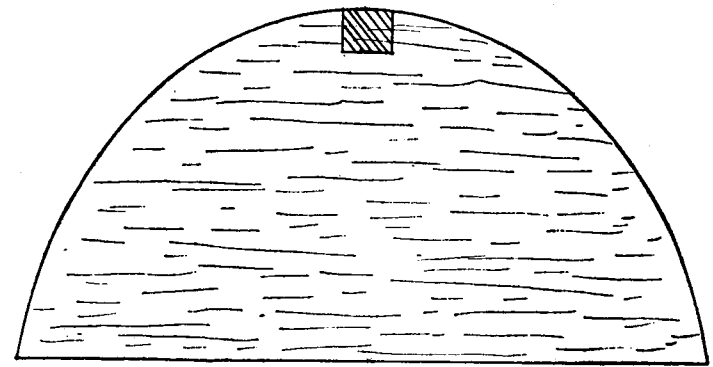
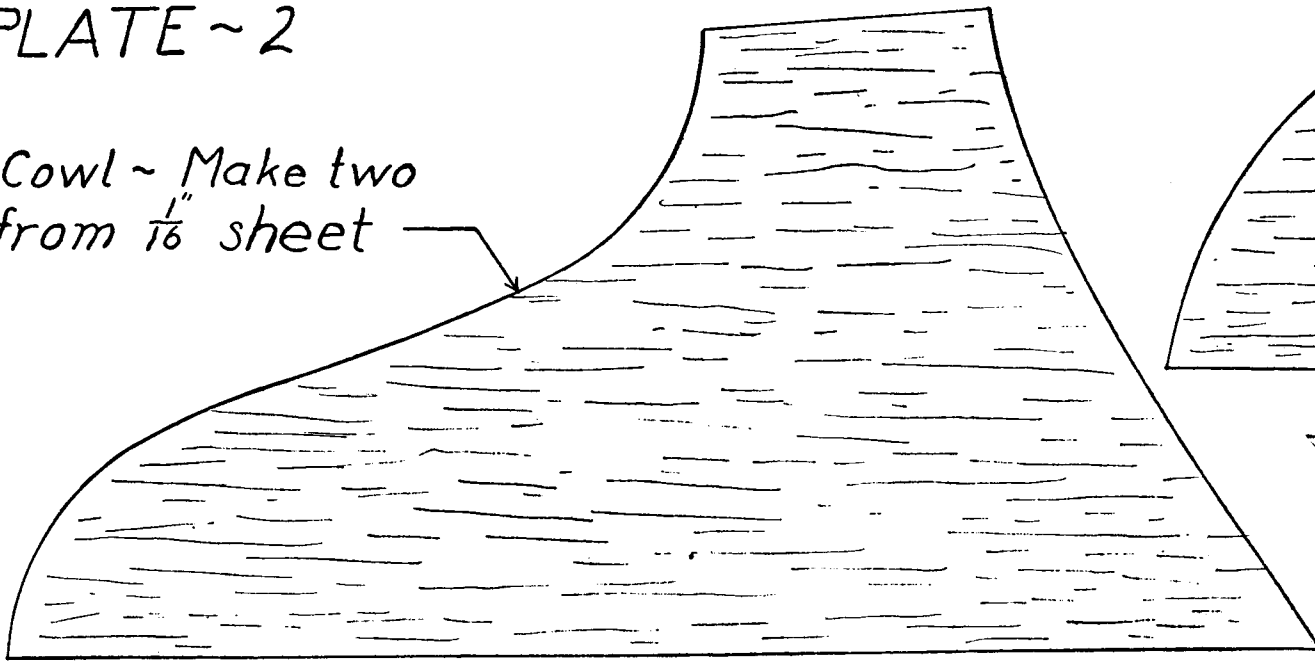

Front former

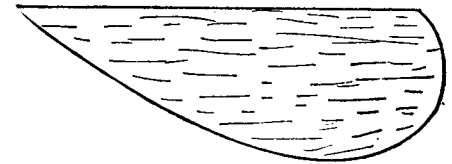

Tailskid is carved
from pine $\frac{1}{4}$ " thick

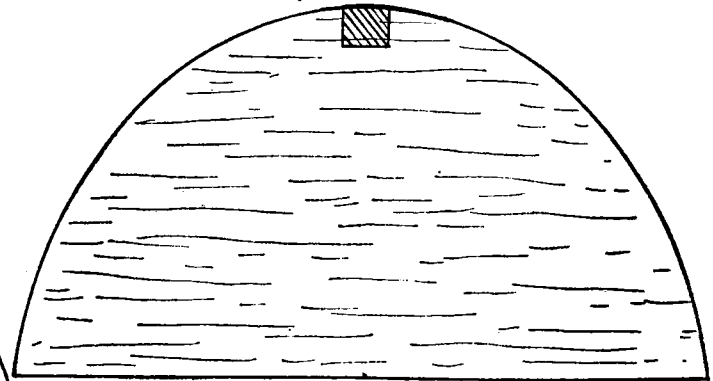

Rear former ~ both
formers are $\frac{1}{8}$ " thick

Windshield Pattern

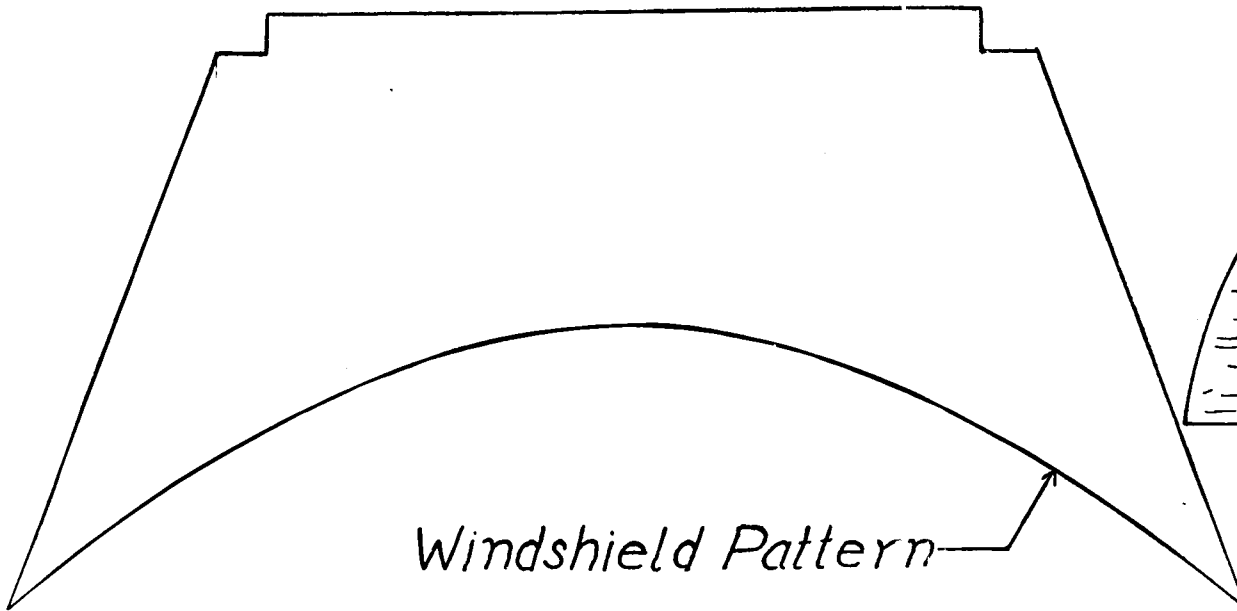

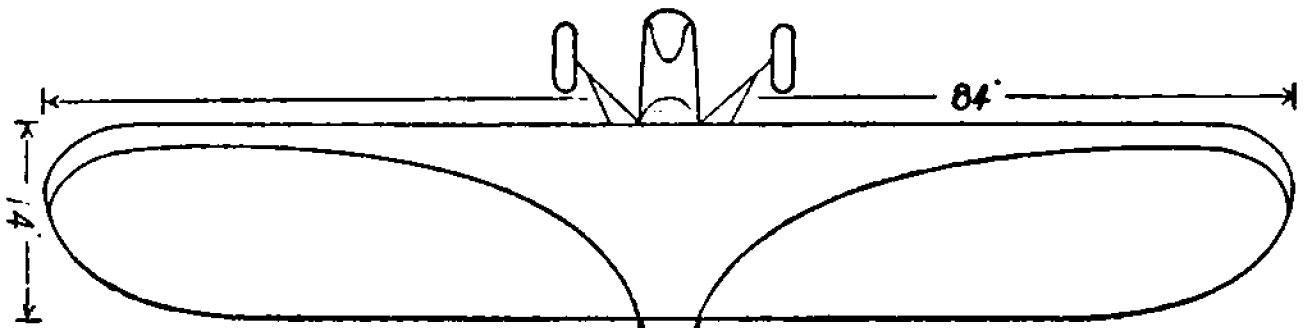

No incidence for wing
or stabilizer

Colour scheme -
Front, red - Rear yellow

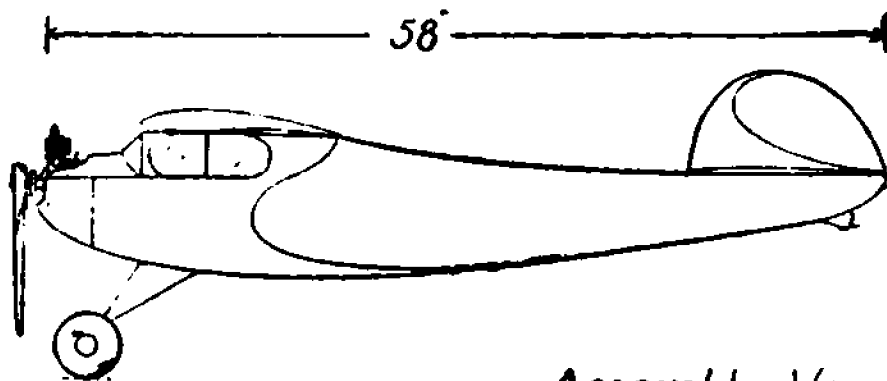
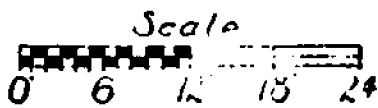
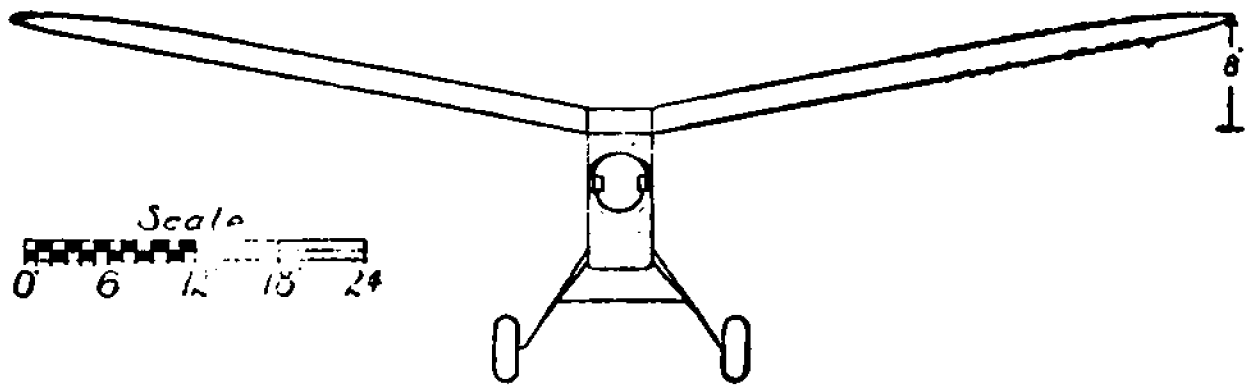
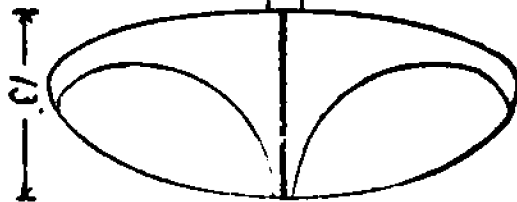

Assembly View