

**- NOTE -**  
 THE ORIGINAL MODEL HAD AN "UPRIGHT" MOUNTED ENGINE. IN A 1937 ISSUE OF POPULAR MECHANICS MAGAZINE THERE IS A PHOTO OF IRWIN HOLDING ONE WITH AN INVERTED ENGINE.....

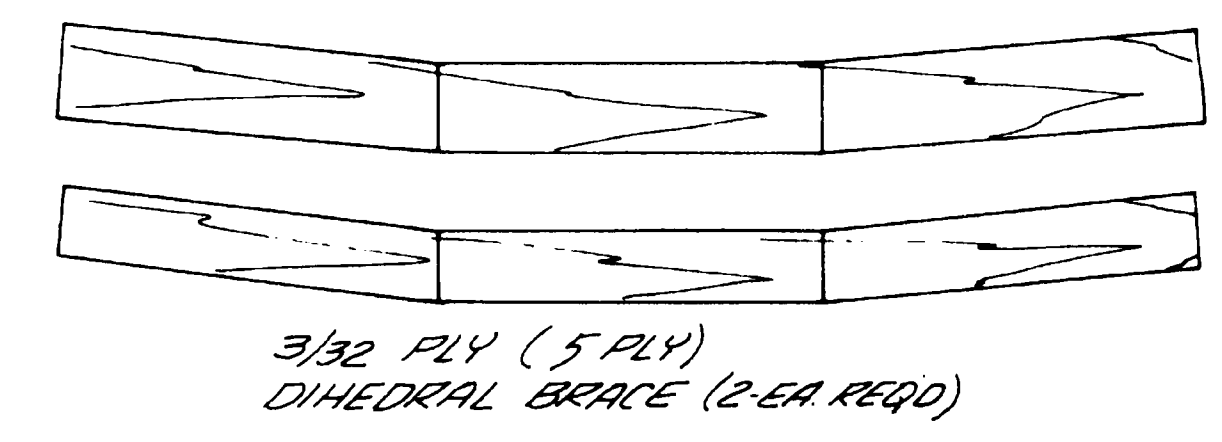

DOCUMENTATION TAKEN FROM PARAMOUNT PRODUCTIONS, INC. PHOTOS DATED 1935. THEY INCLUDE IRWIN OHLSSON, HIS MODEL AND MOVIE STARLET CATHERINE BURKE. THE ORIGINAL ENGINE AND PHOTOS ARE NOW IN THE IRWIN OHLSSON COLLECTION.....

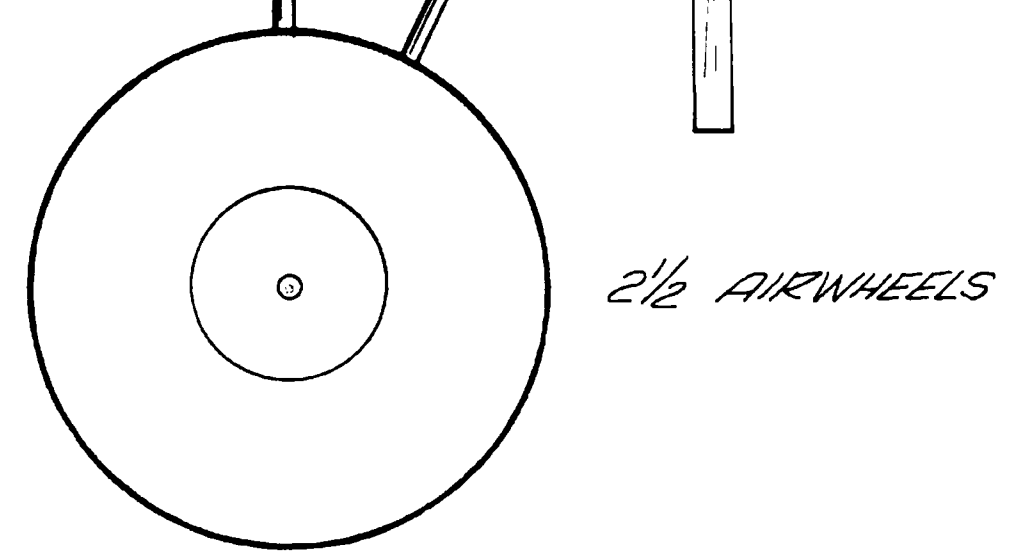
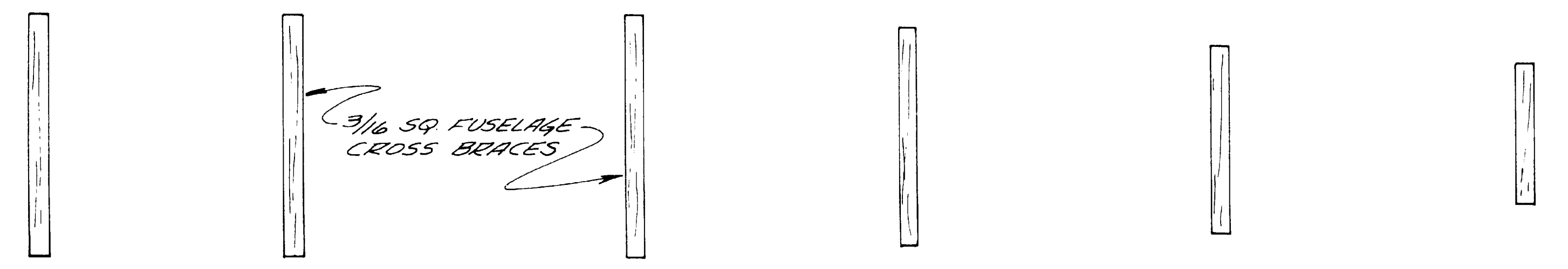
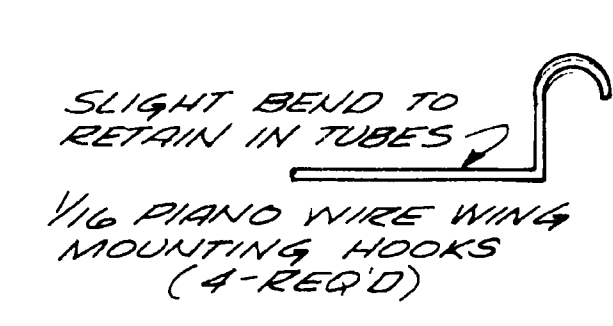
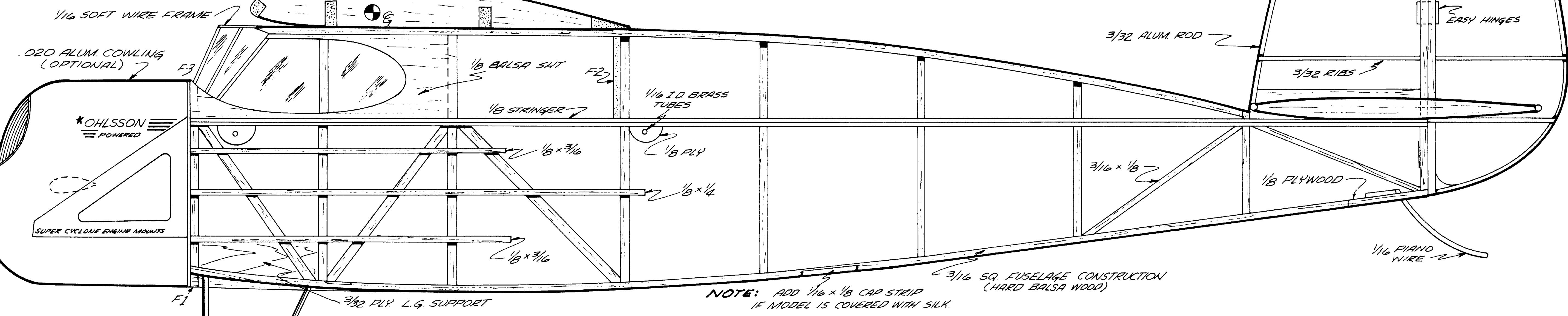
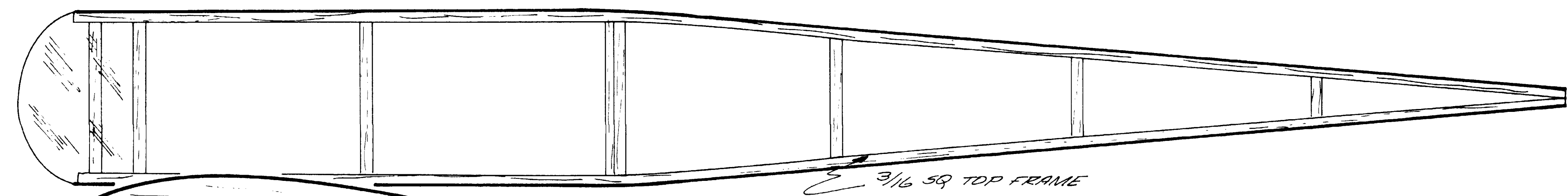

**OHLSSON 1934 CABIN MODEL**  
 POWERED BY OHLSSON "ORIGINAL" .12  
 FLYING WEIGHT 24 oz.  
 DRAWN BY DAN C. LUTZ 7-15-86  
 TRACED FOR R.C.M.B. BY AL. NOVOTNIK

3/32 ALUM. ROD (WELDING ROD)

3/32 RIBS  
18-REQ'D

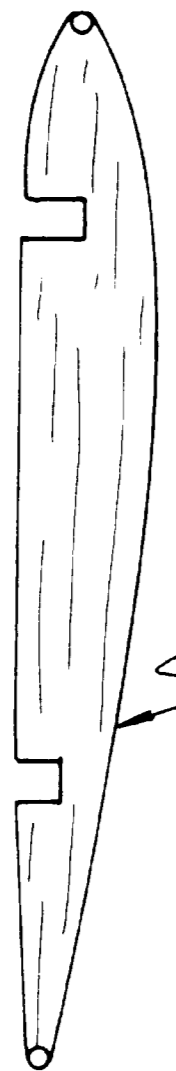
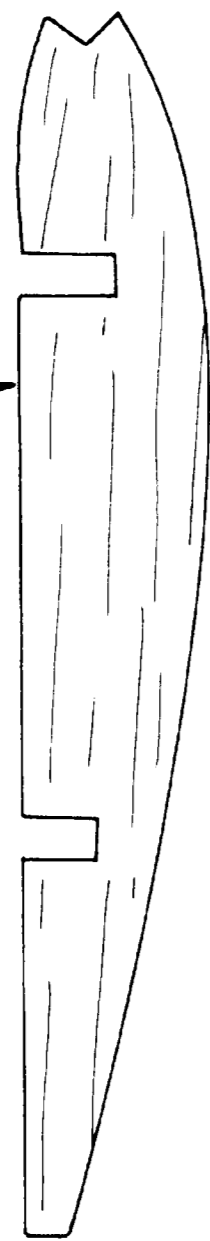
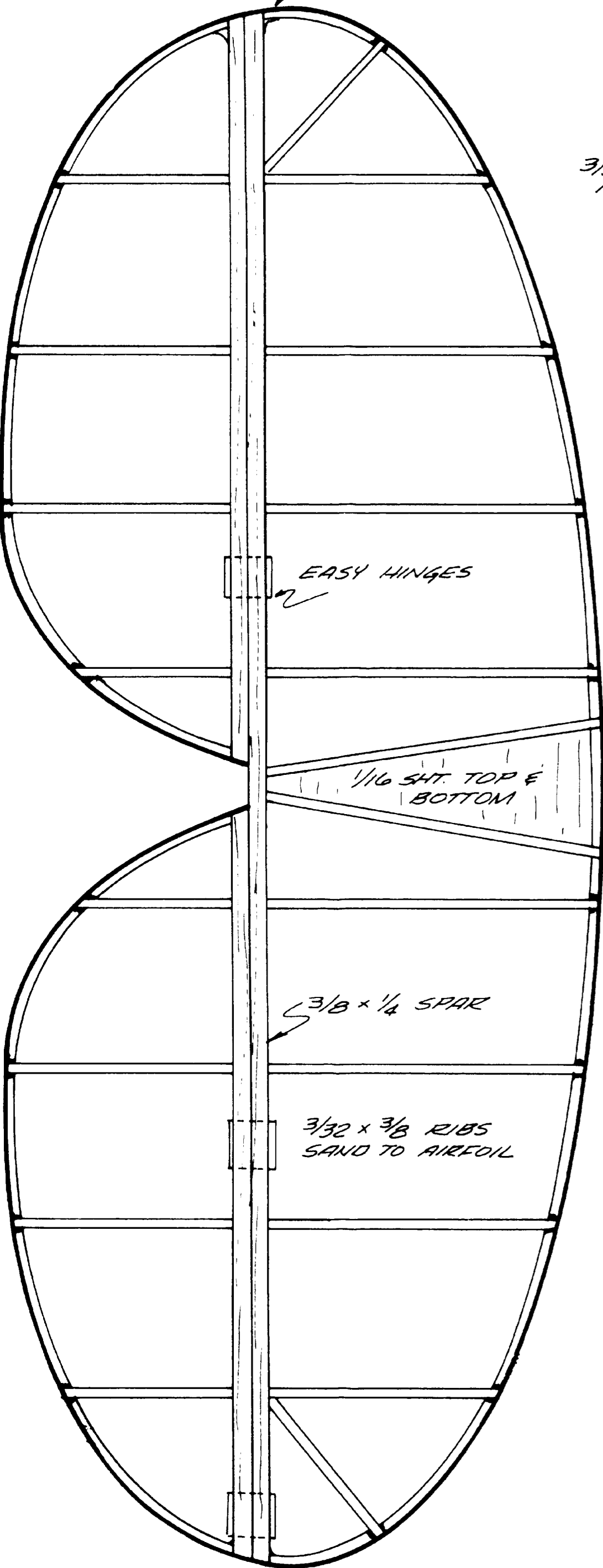

TIP RIB  
(2-REQ'D)

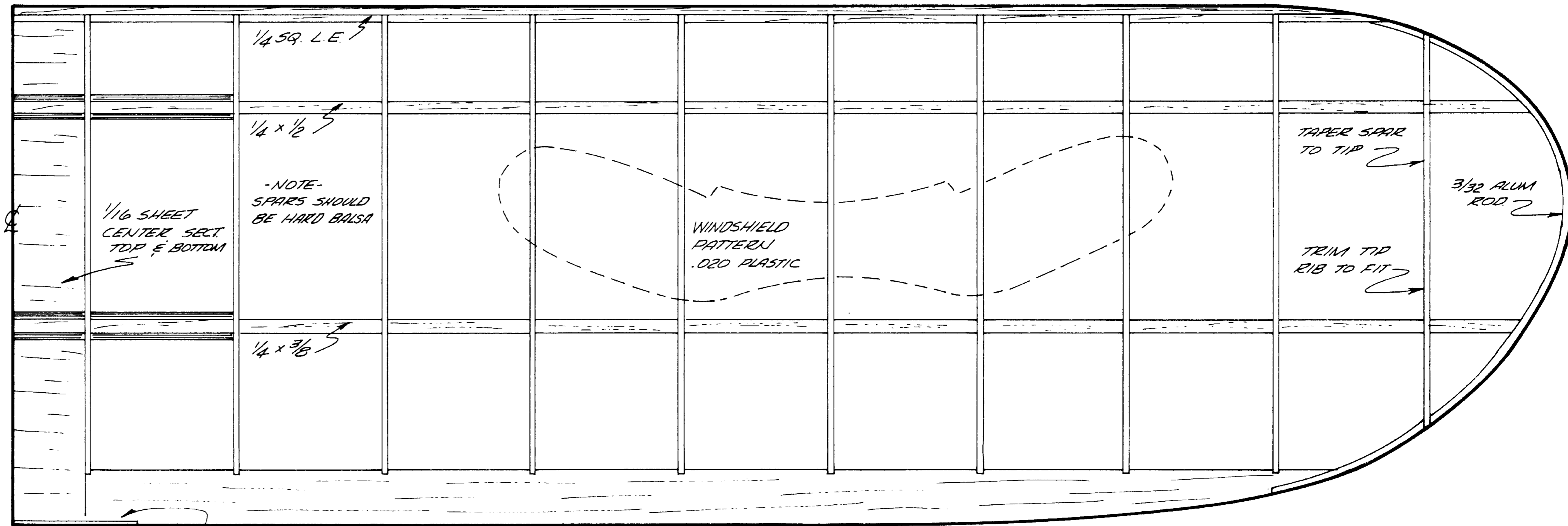

.045 PIANO WIRE  
T.E. PROTECTOR

3/4 x 1/4 T.E.

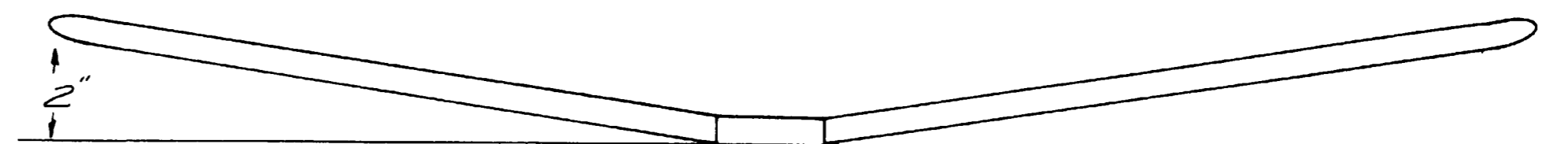

2" DIHEDRAL UNDER EACH TIP

