

NOTE: ORIGINAL MODEL HAD RIBLETS BETWEEN EACH RIB THEY ARE NOT REQ'D

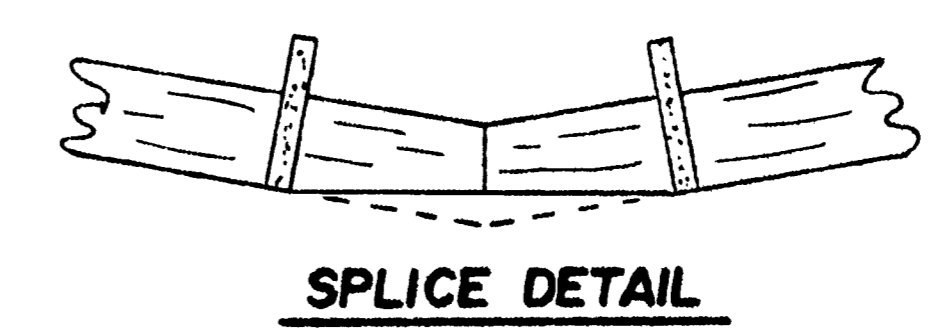

4" DIHEDRAL BOTH TIPS

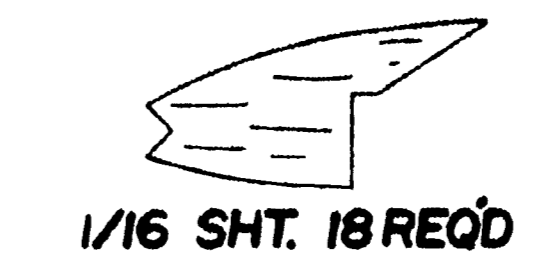
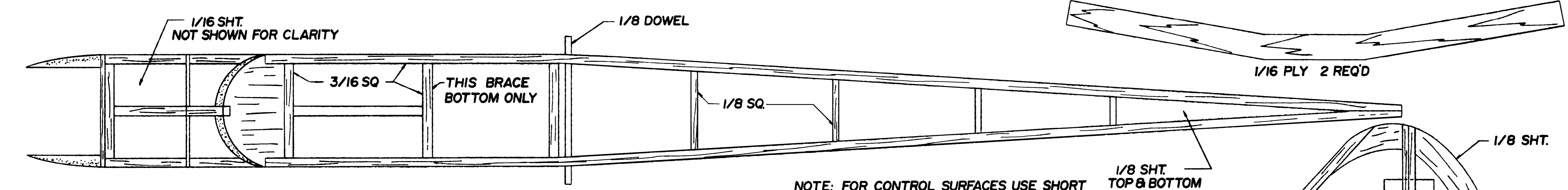

NOTE: FOR CONTROL SURFACES USE SHORT CONTROL HORNS & ROCKET CITY SUPER FLEX NYLON STRIP HINGES CUT 5/16 WIDE. HOT STUFF HINGES IN PLACE

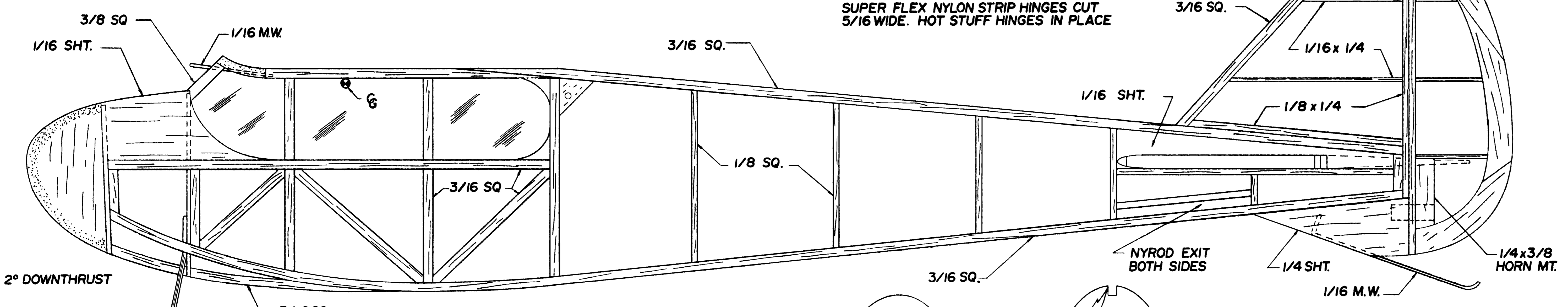

NOTE: STAB & RUDDER ARE BUILT FLAT & THEN SANDED TO SHAPE. SHIM UP LEADING & TRAILING EDGES AS REQ'D

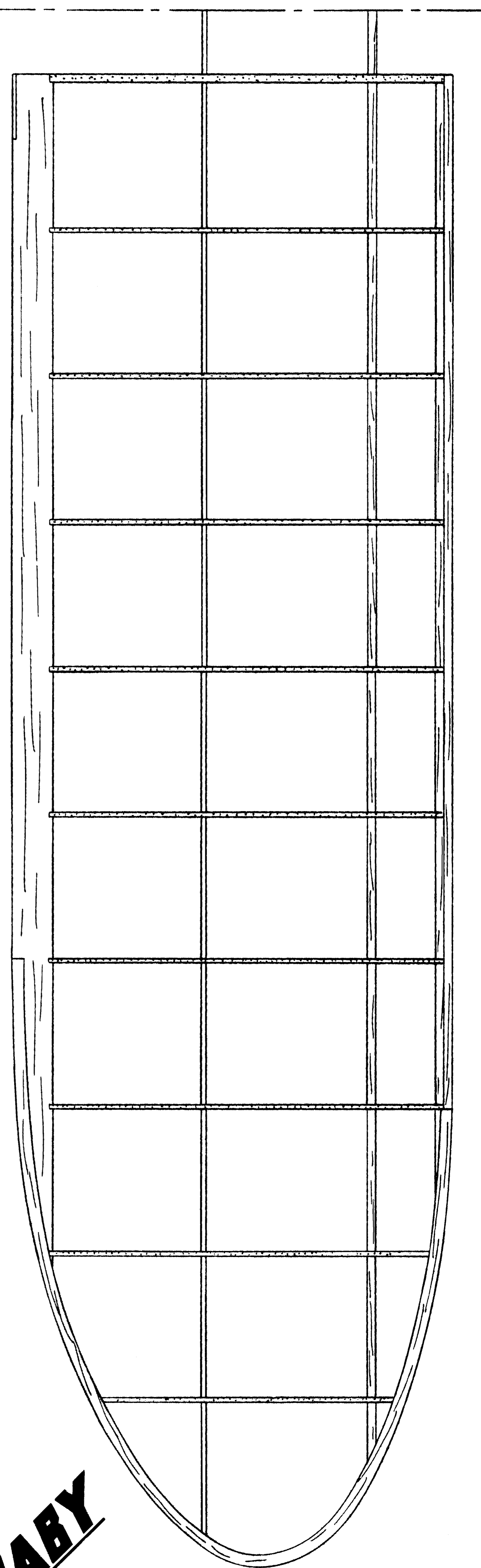
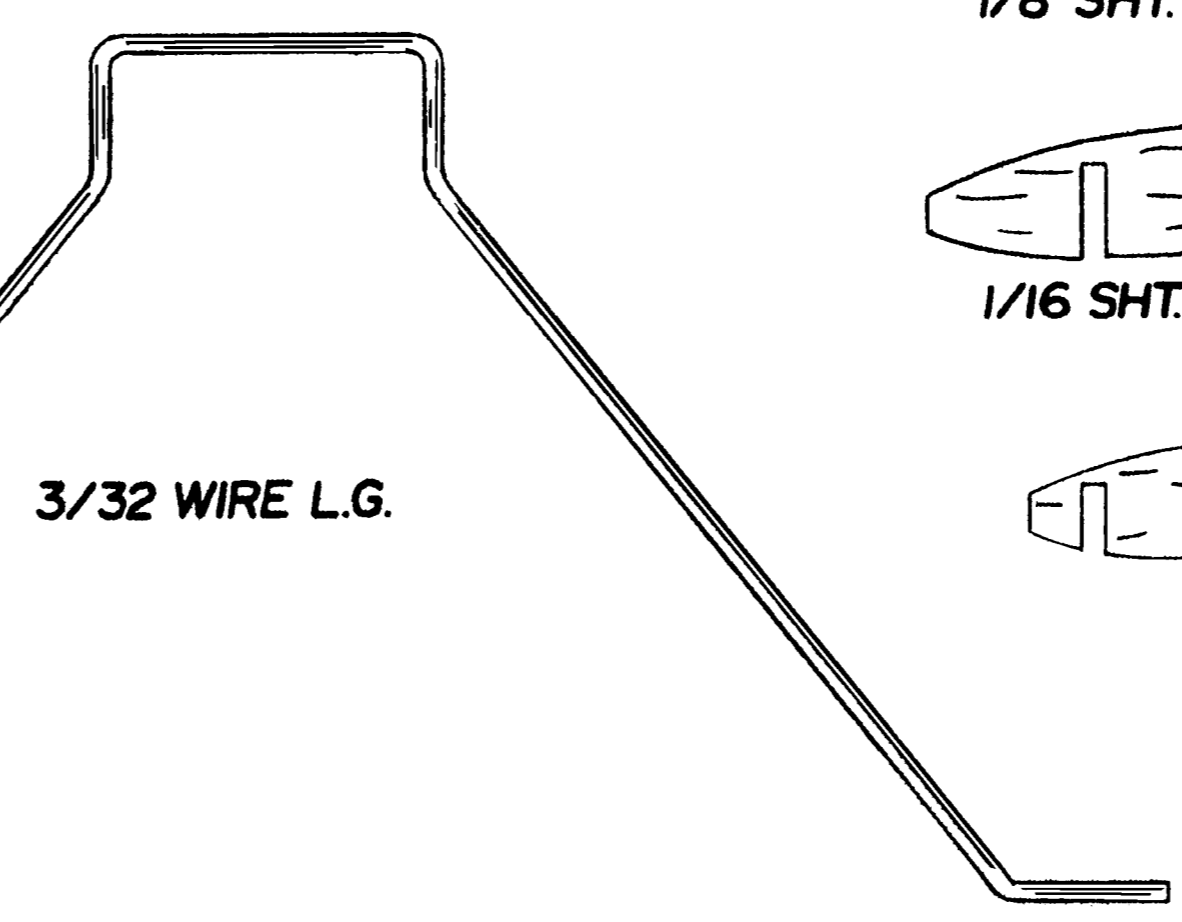
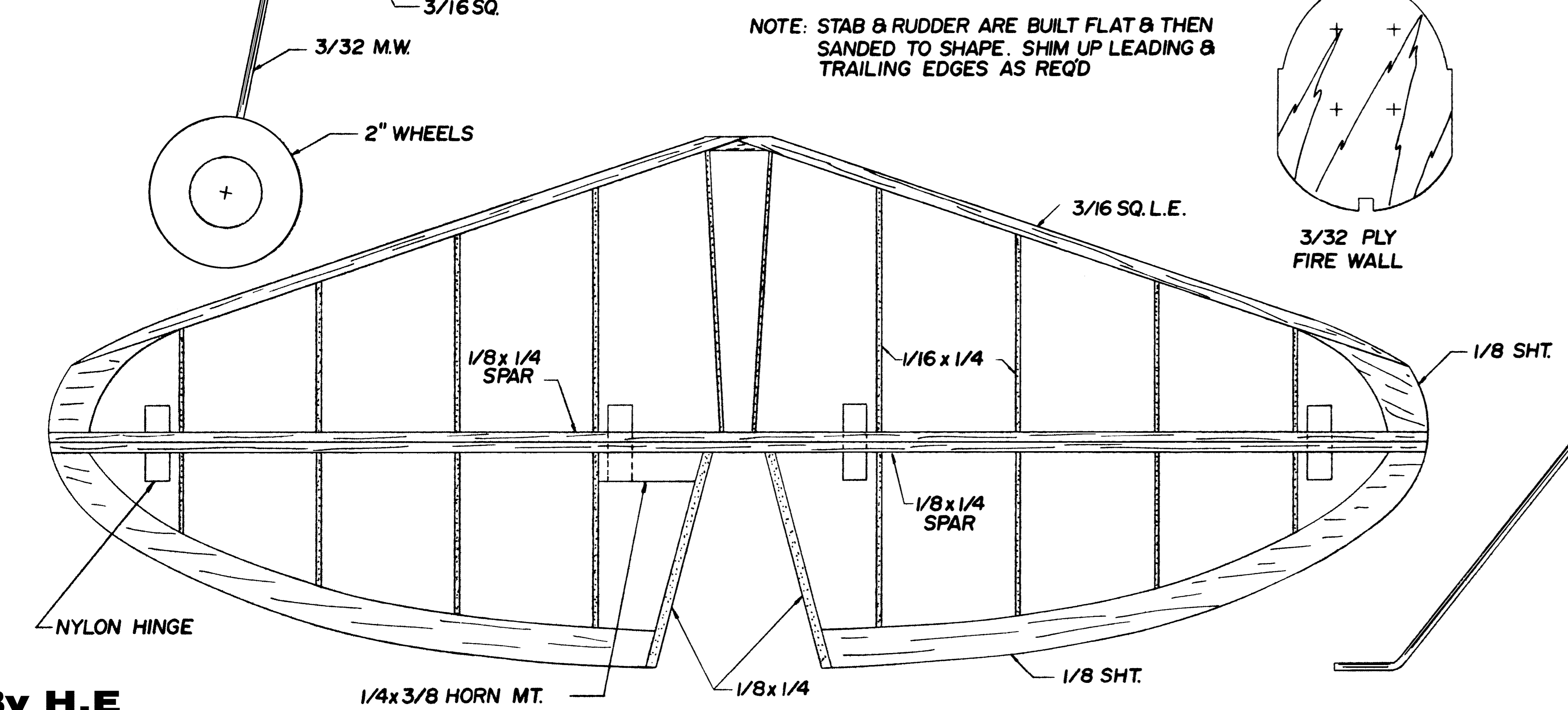
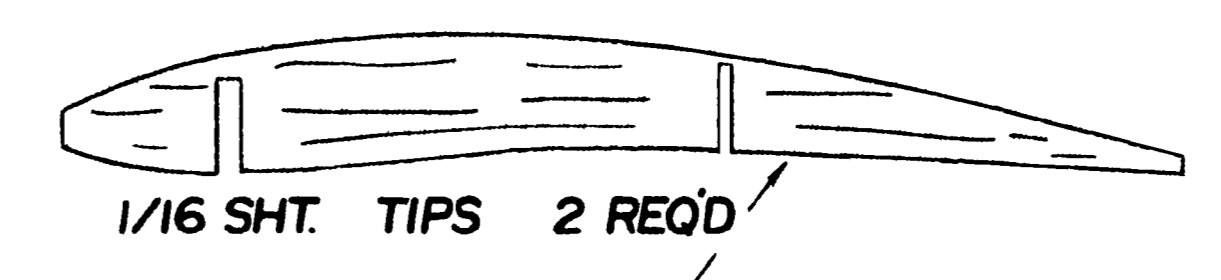
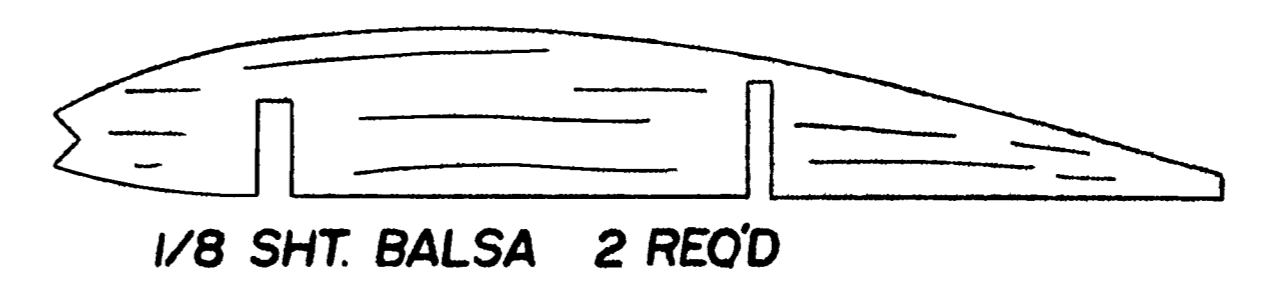
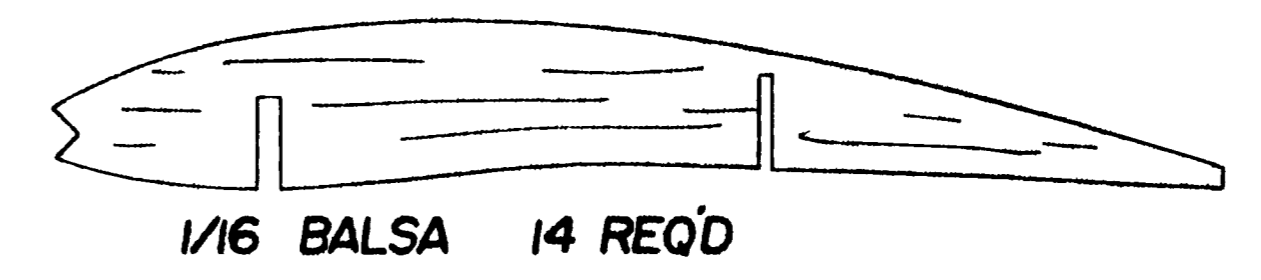
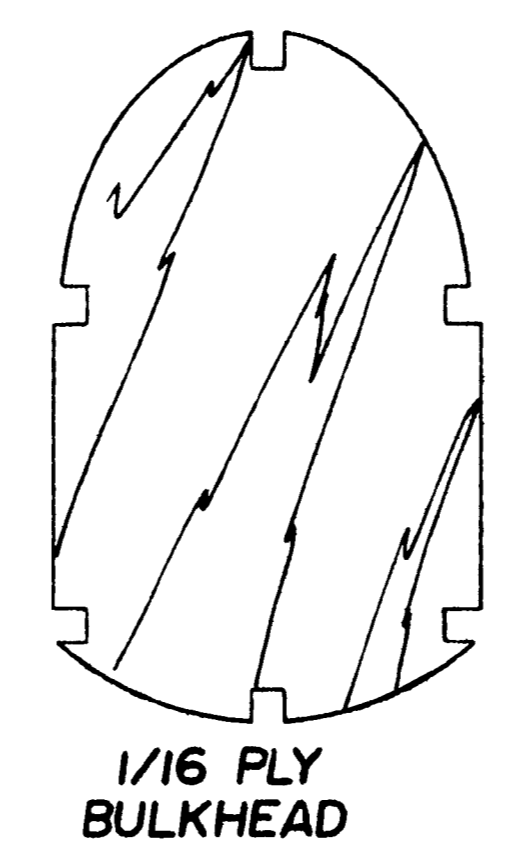
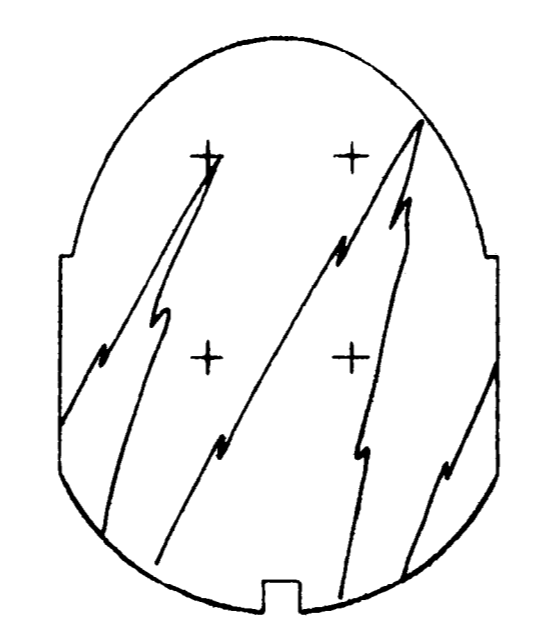

FLY BABY

Designed by PETER M. BOWERS
Conversion to R/C 1/2A TEXACO
By KELSO BARNETT & JIM REYNOLDS

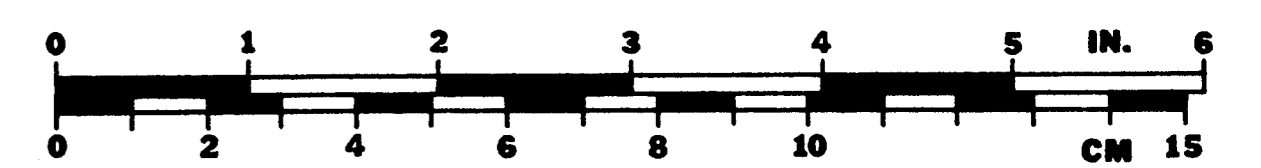

MODEL BUILDER magazine
Plan No: 7842

By H.E