

▷ DIMENSIONS TO BUNT ENAMEL USED

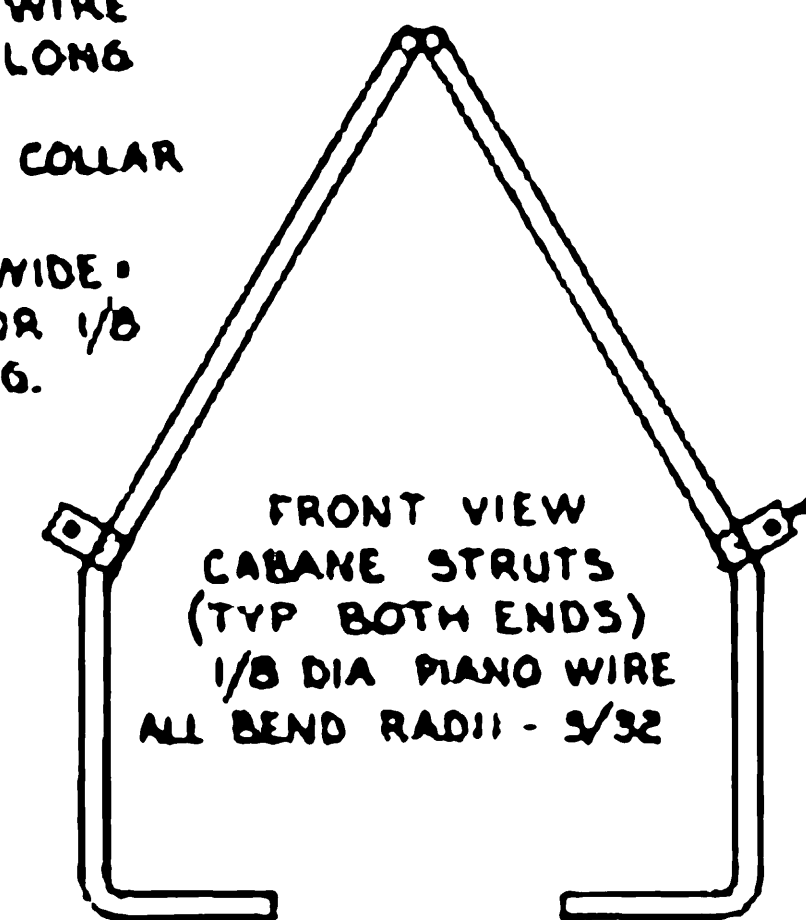

025 BRASS SHEET - WRAP AROUND CABANE & SOLDER DRILL 1/16 DIA HOLE (TYP 4 PLCS)

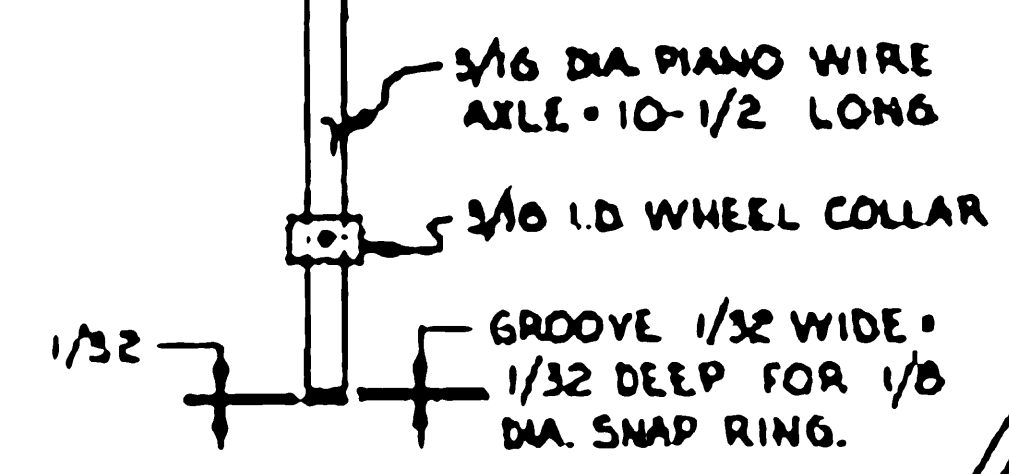
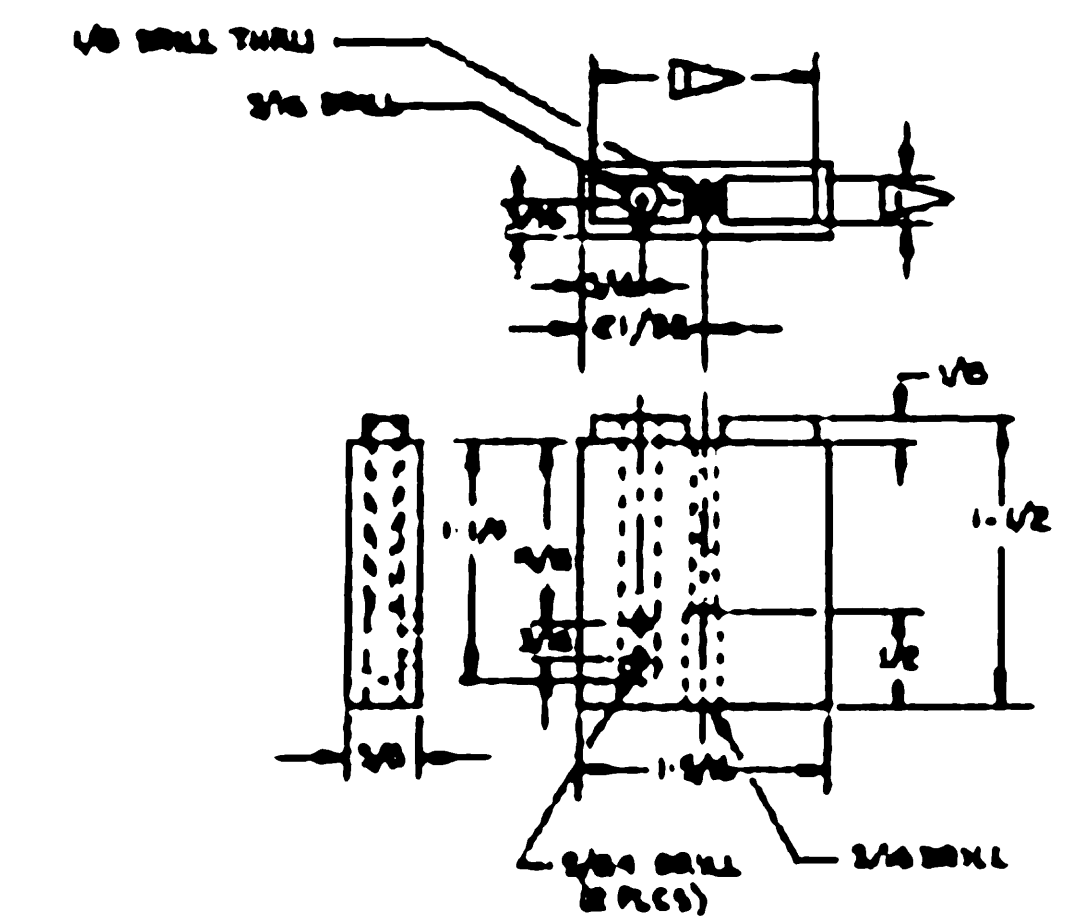
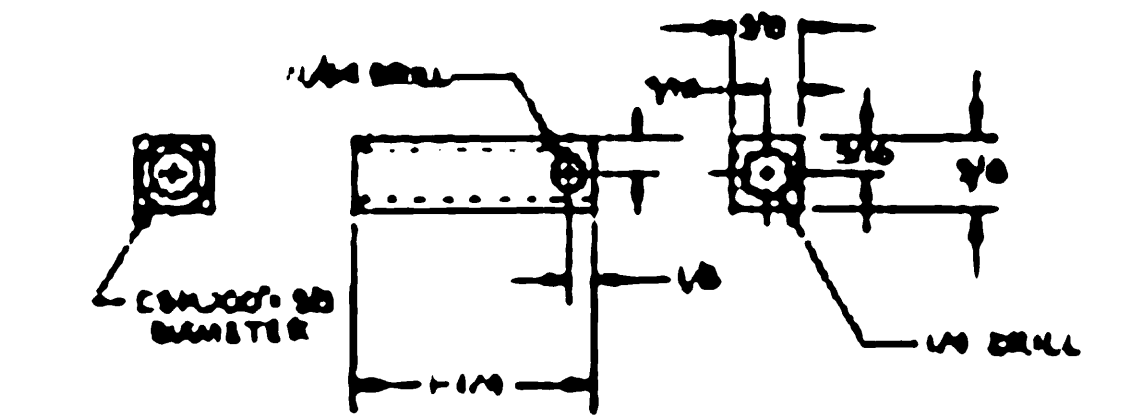
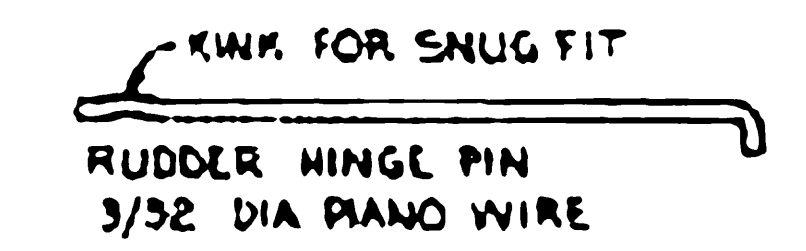
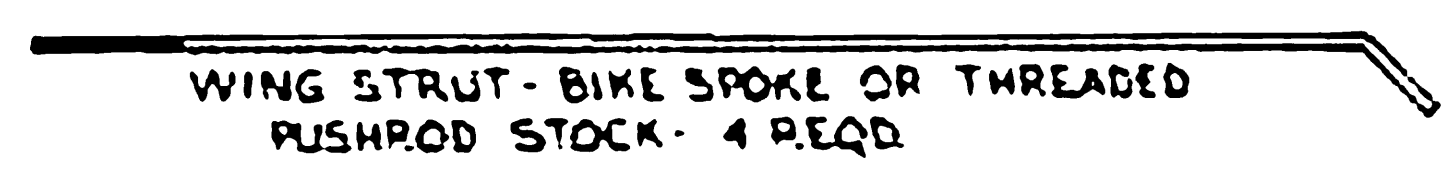

NOTE: ALL MATERIAL IS Balsa UNLESS INDICATED OTHERWISE.

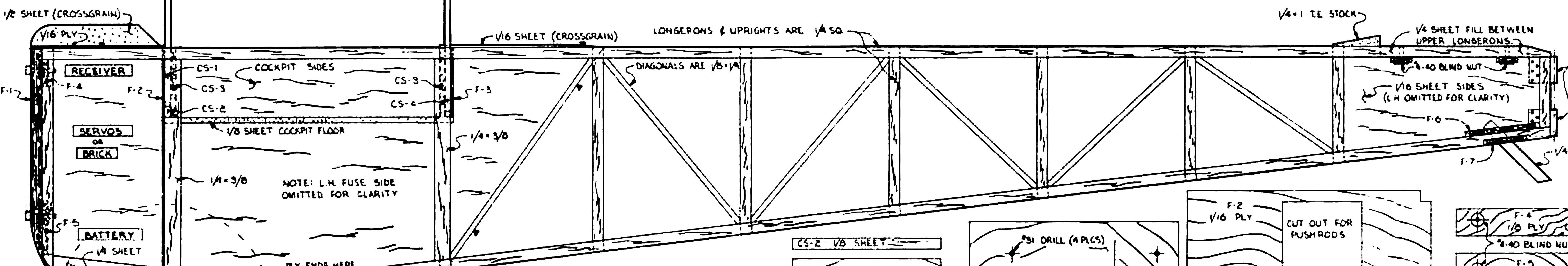
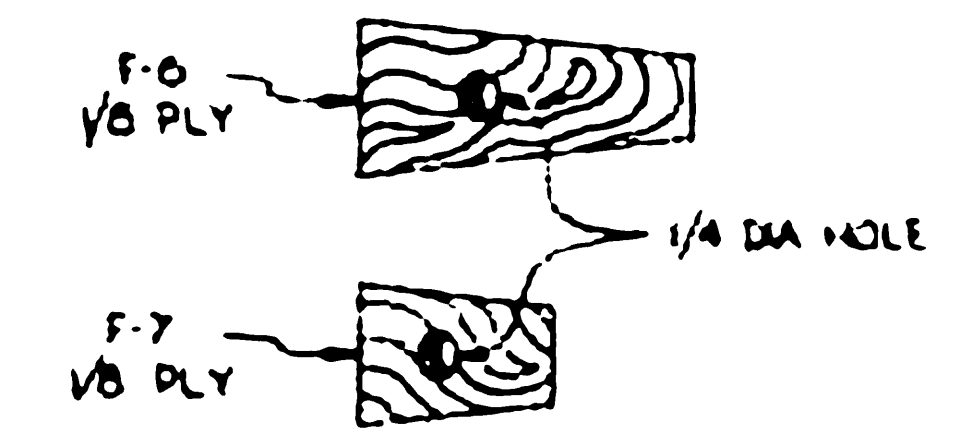
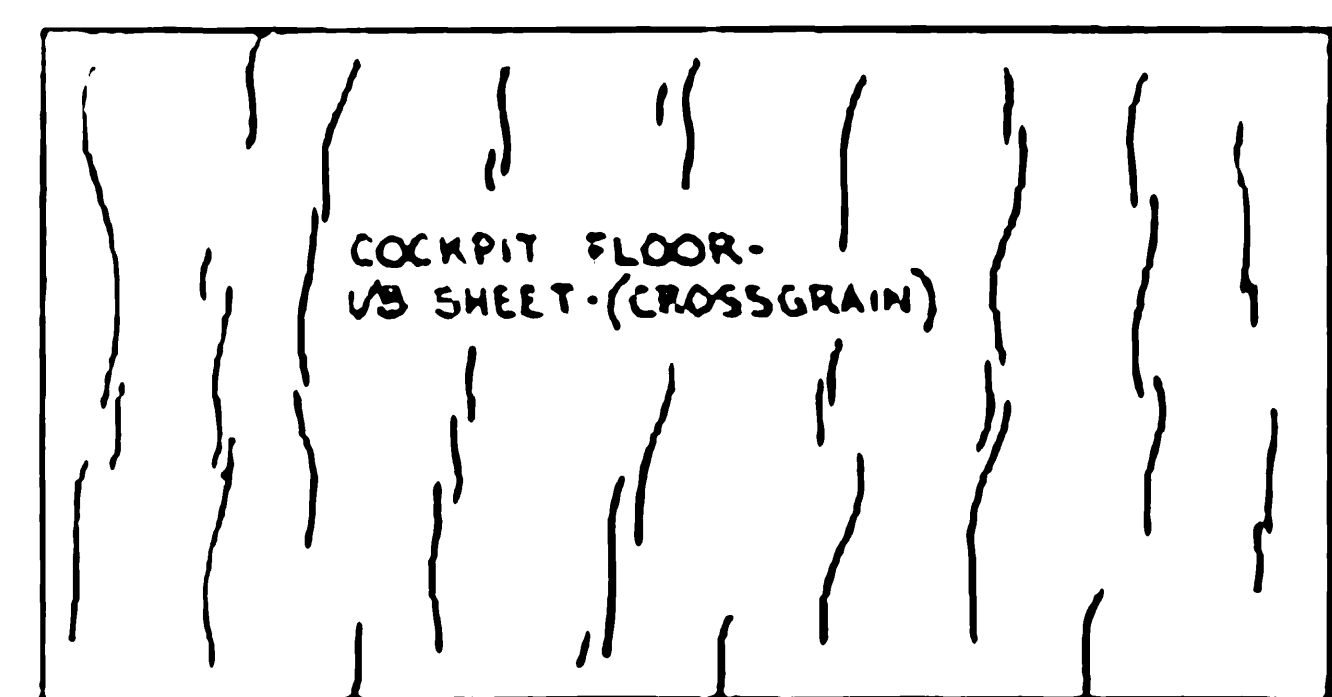
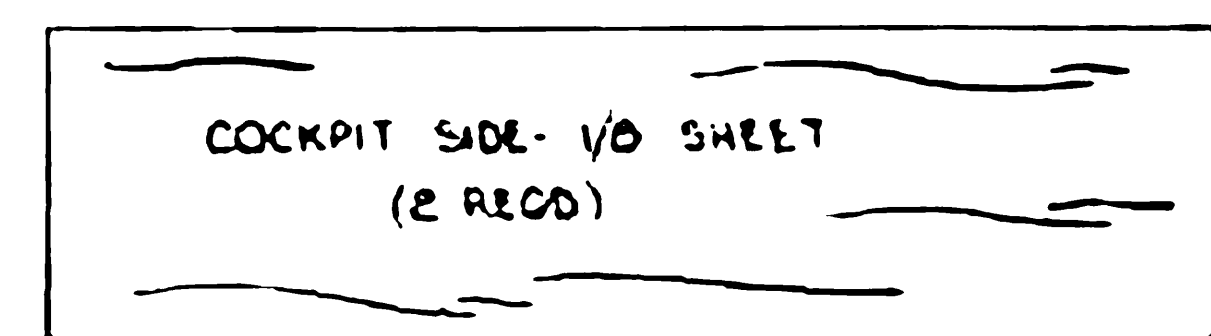
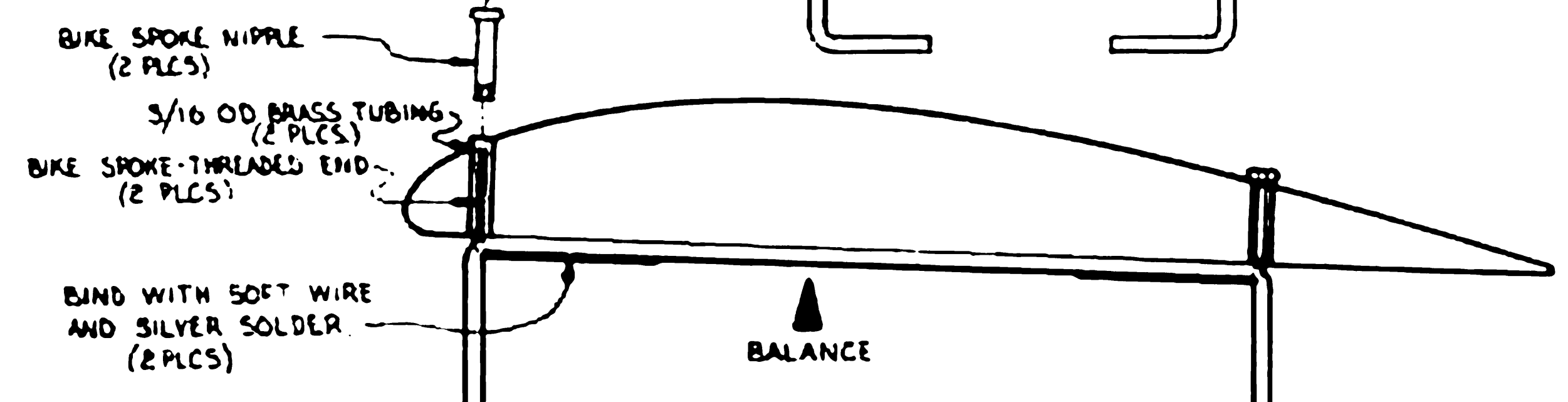

SEE SHEET 2 FOR RUDER HINGE DETAILS.

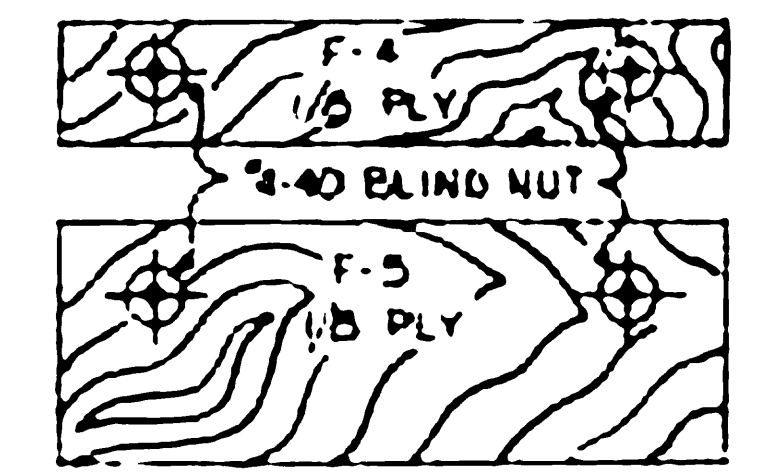
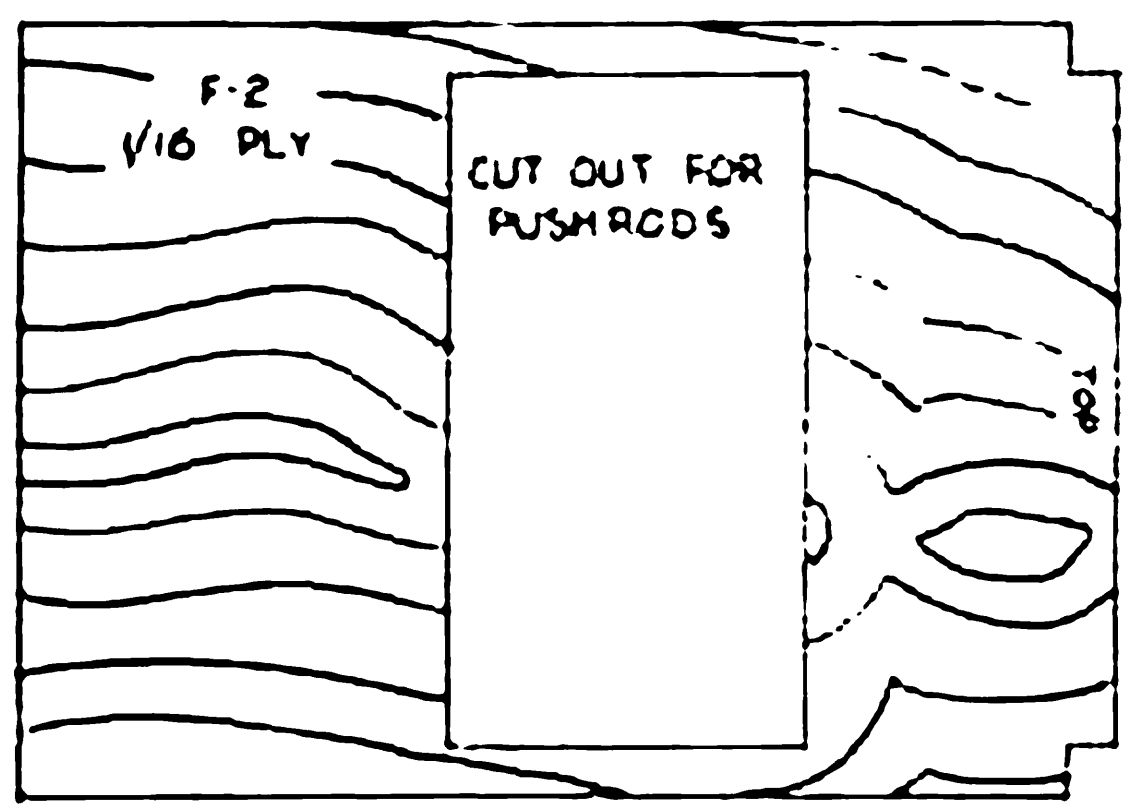
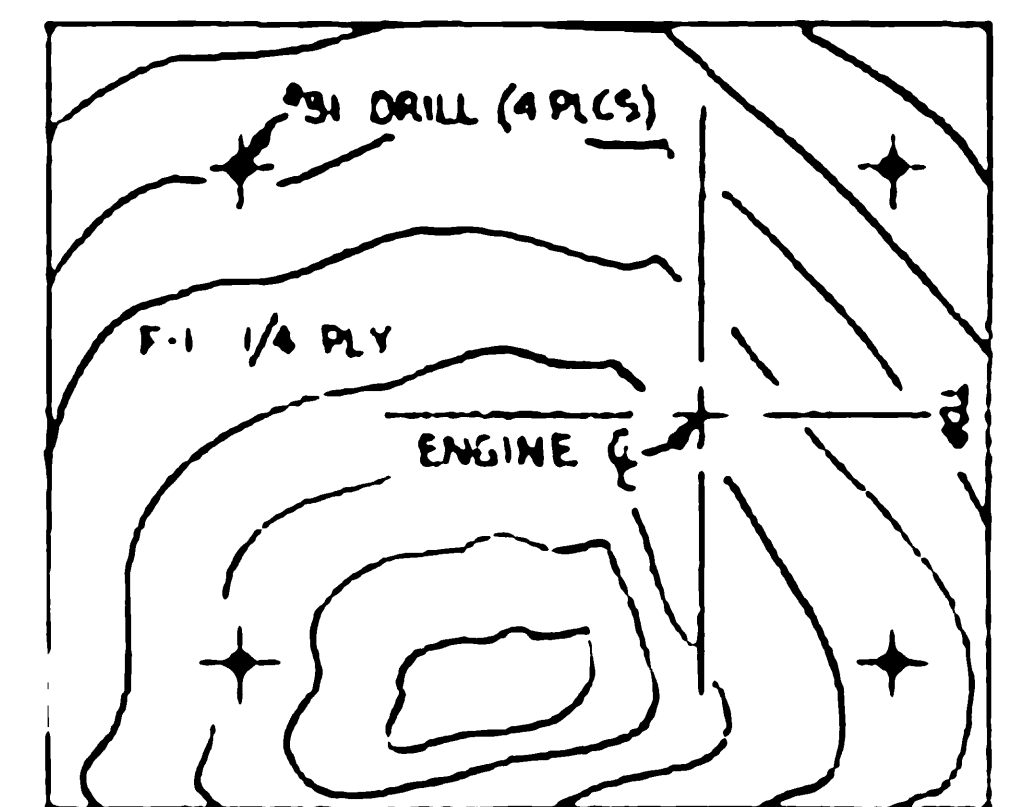
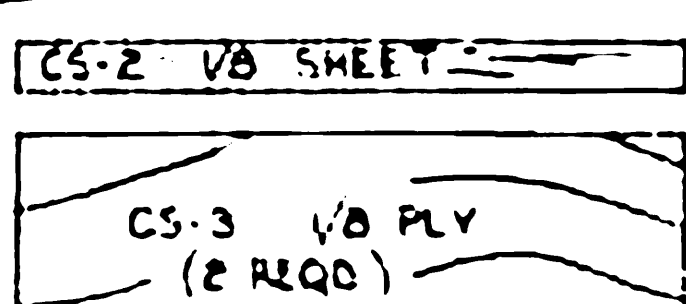
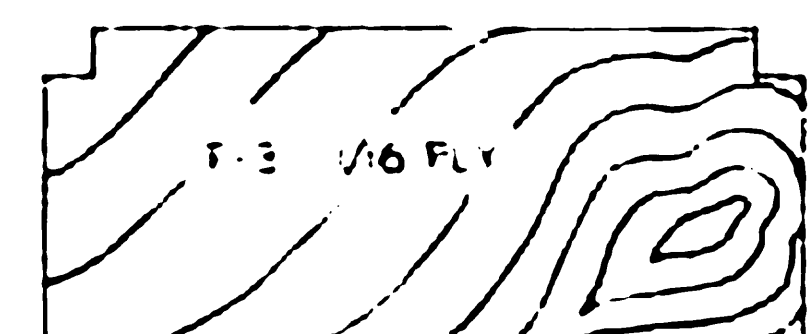
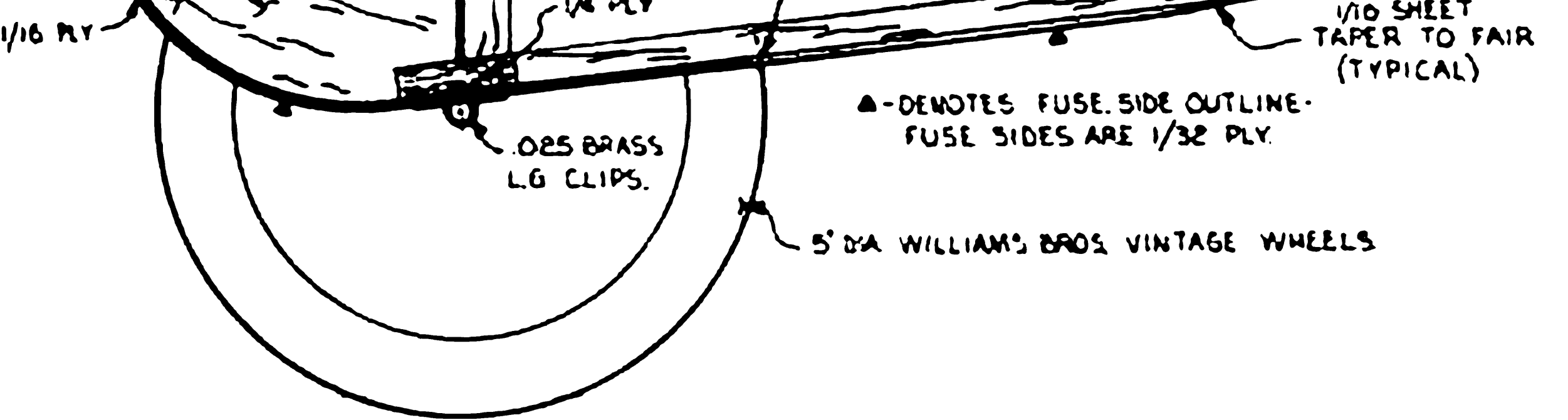

SPAN - 74"  
 AREA - 703 SQ. IN  
 LENGTH - 32.5"  
 POWER - MODIFIED FOX 36

# ALBATROS SPORT FLUGZEUG

DESIGNED BY: JEFF BREECE  
 DRAWN BY: CHIC BUMGARDNER  
 DETAILED FOR MODEL BUILDER BY: S. A. PATTERSON  
 SHEET 1 OF 2

0 1 2 3 4 5 6 inches

**MODEL BUILDER** magazine  
 Plan No: 5761-A

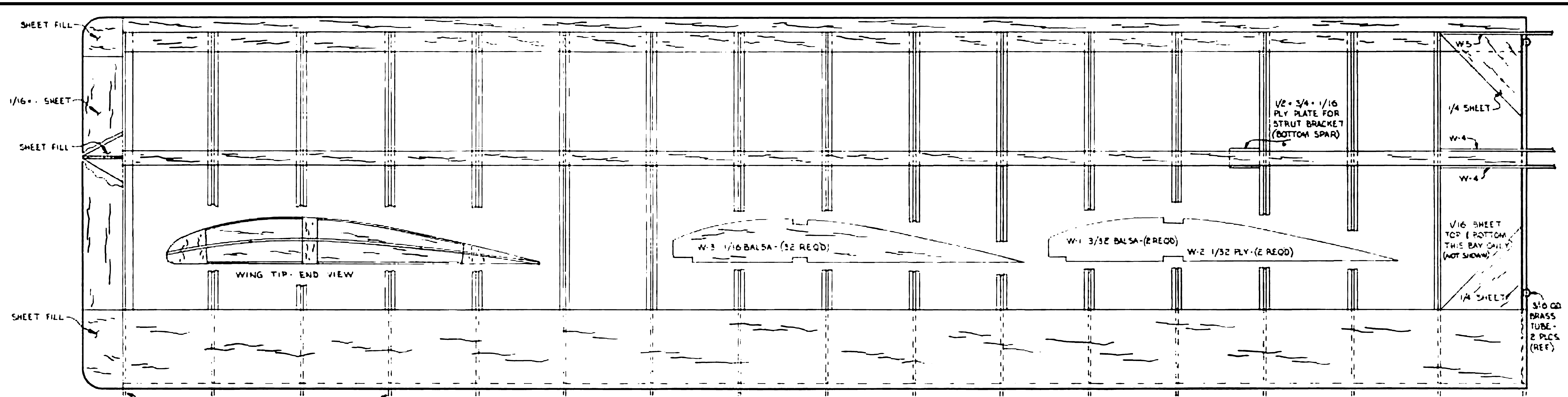

GUIDES TO ALIGN RIBS DURING CONSTRUCTION

NOTE: TOP L.E. SHEETING, TOP CAP STRIPS, AND SHEAR WEBS OMITTED FROM WING PLAN VIEW FOR CLARITY.

STRUT BRACKET DETAILS

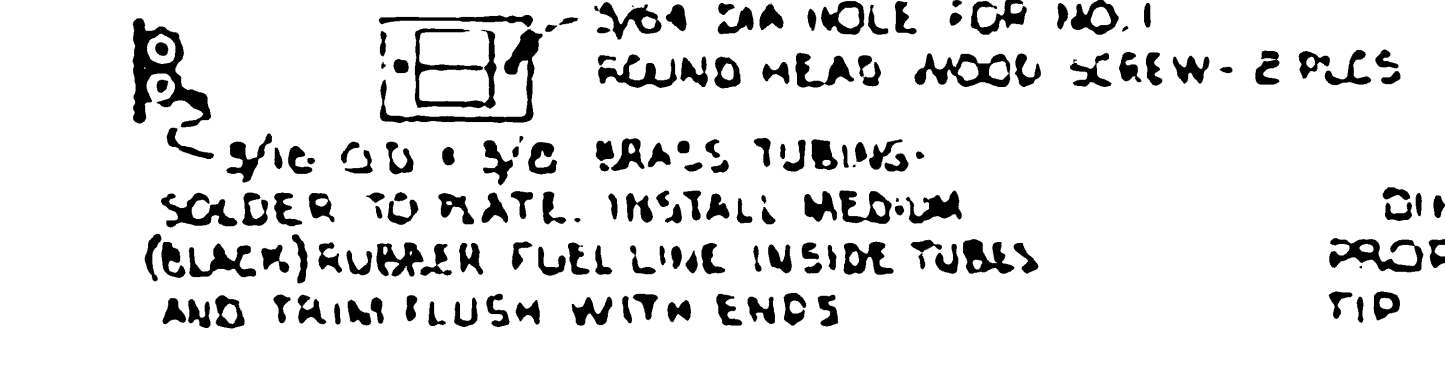

DIHEDRAL ANG. L: PROP UP ONE WING TIP 3-3/4 WHEN JOINING.

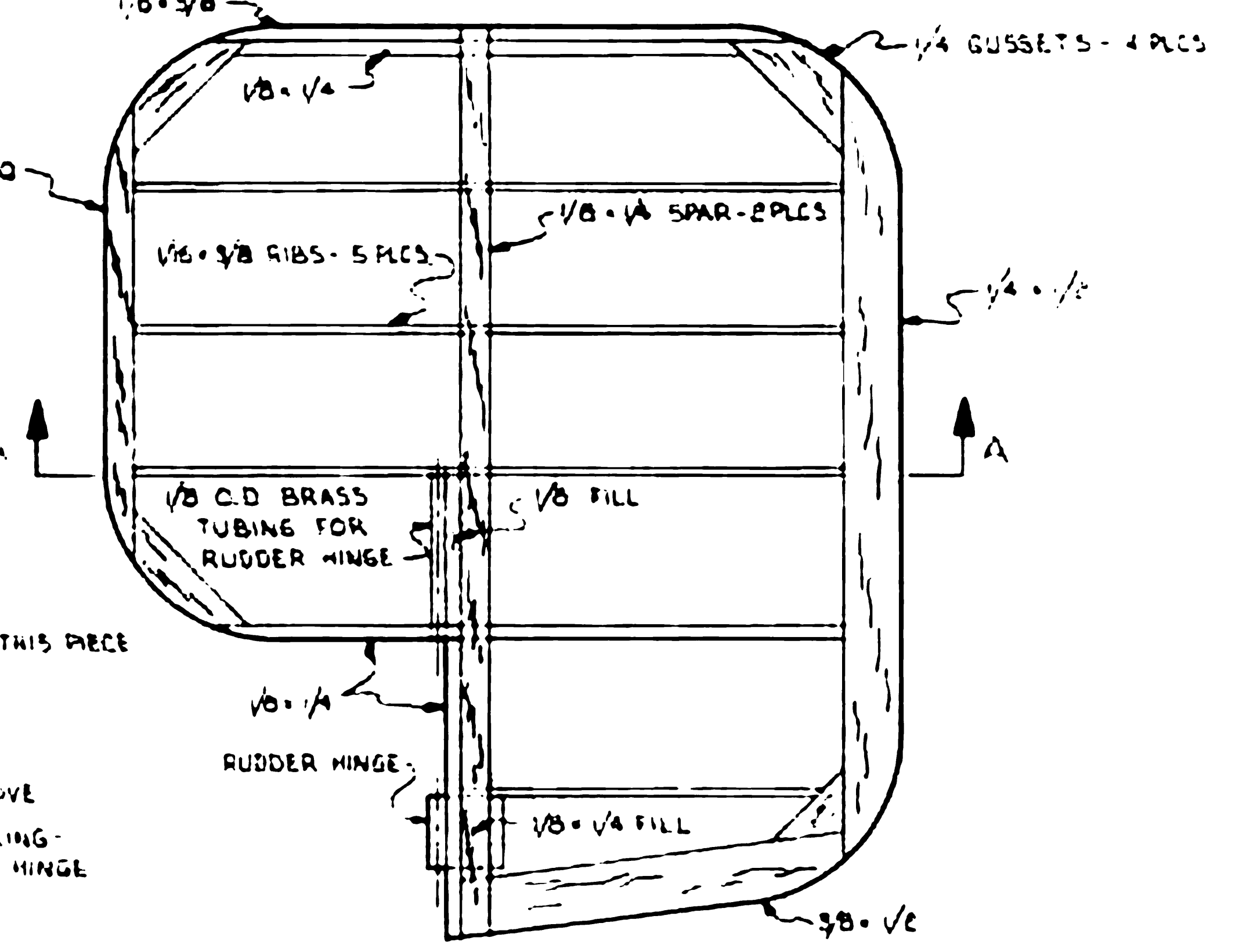
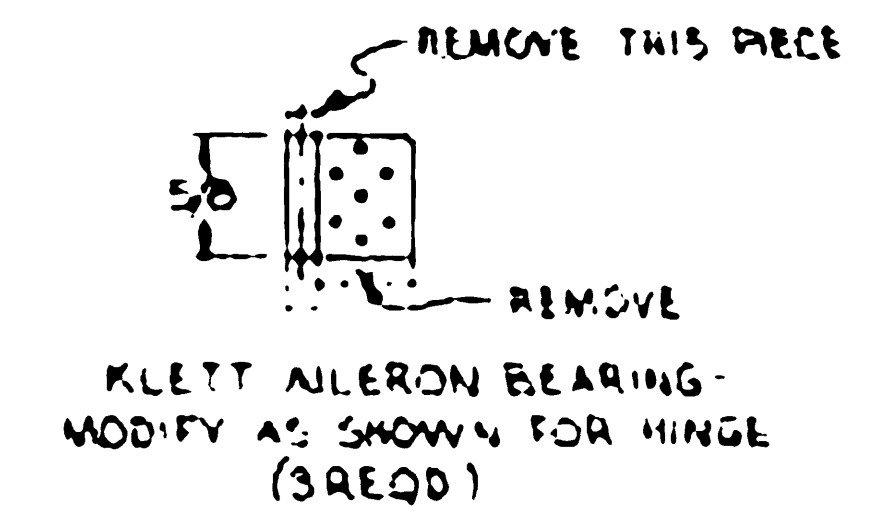
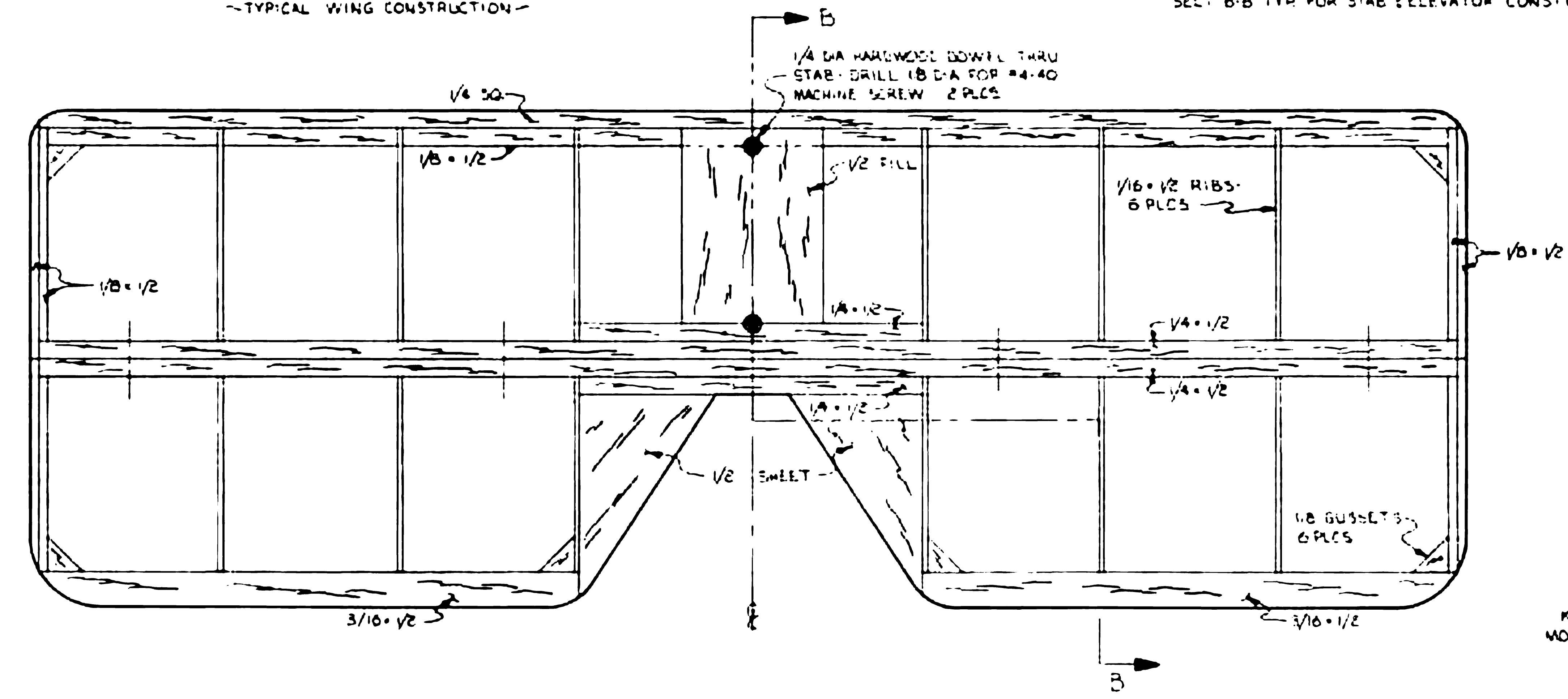
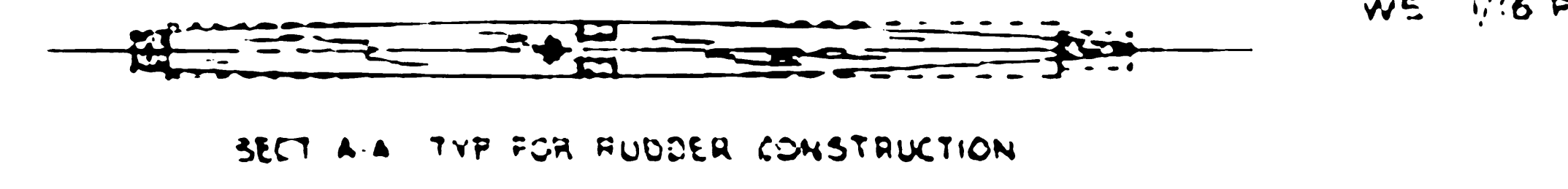
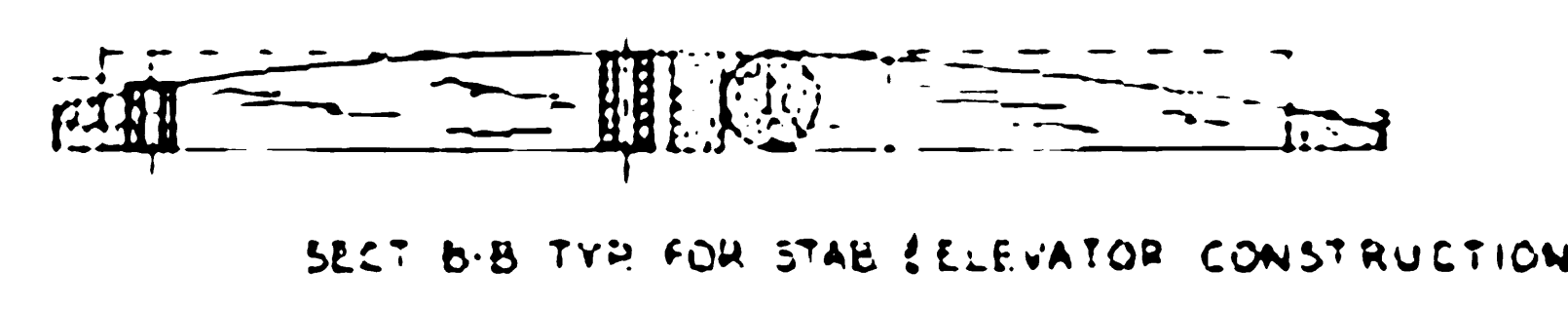
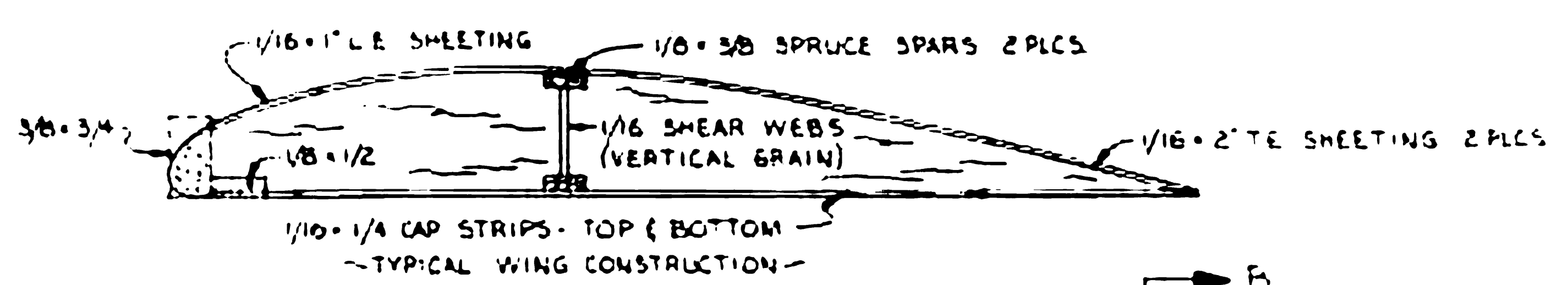
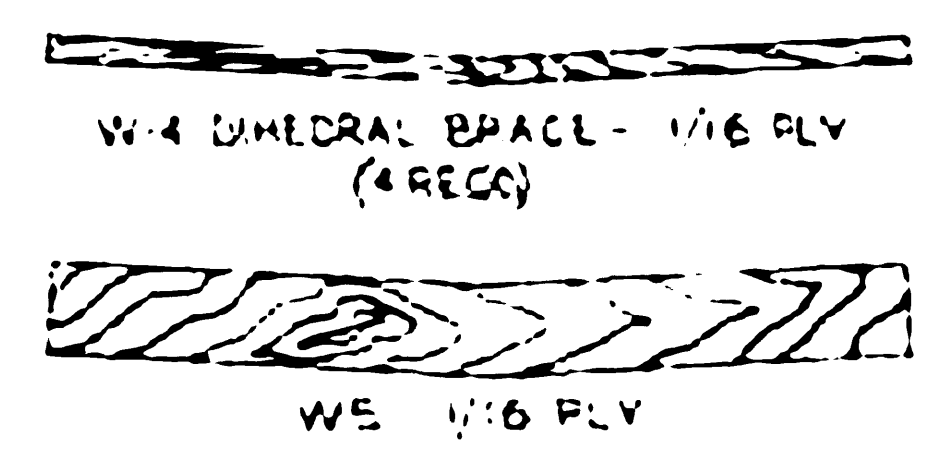

NOTE ALL MATERIAL IS BALSA UNLESS OTHERWISE INDICATED