

1/16 TH SHEET Balsa STRUT SUPPORTS
UNDER SPAR ON TOP WING, - OVER SPAR ON BOTTOM WING

BOTTOM WING ROOT RIBS

TOP WING ROOT RIBS
1/8 BY 1/4 LEADING EDGE

3/32 BY 3/8 MAIN SPAR

3/16 TH THICK TIPS

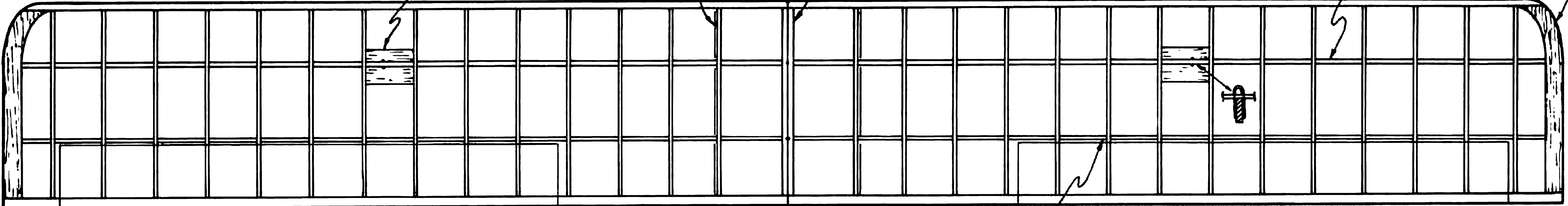

NOSEBLOCK
DETAIL

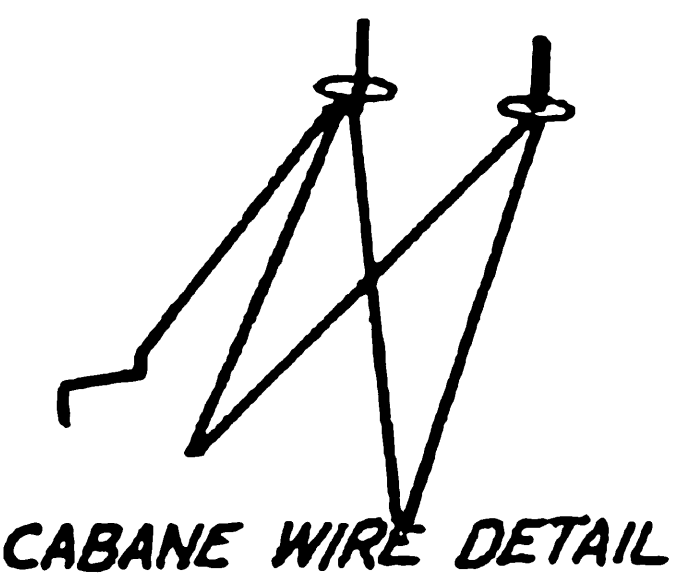
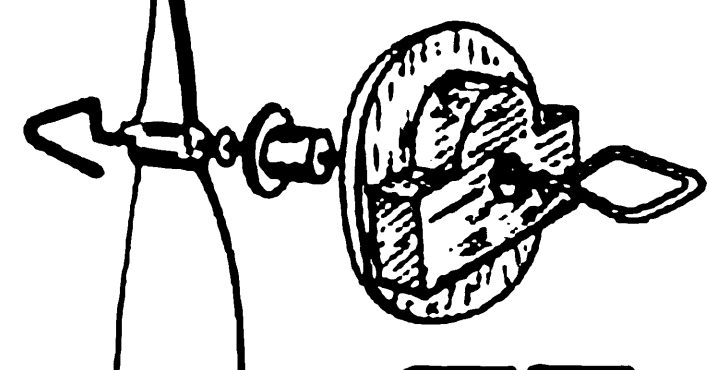

1/16 BY 3/16 TRAILING EDGE

WING PLAN

1/16 BY 1/4 AFT SPAR
1/8 TH THICK TIPS

AILERONS ARE ON BOTTOM WING ONLY

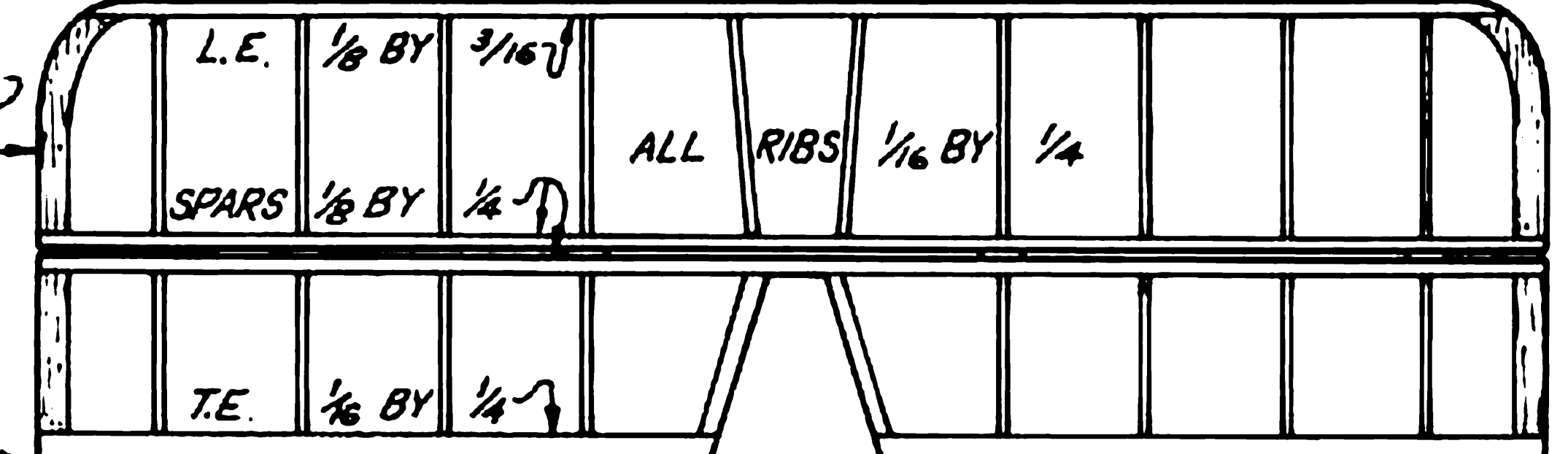

TAB IS ON RIGHT ELEVATOR ONLY
TAIL PLAN

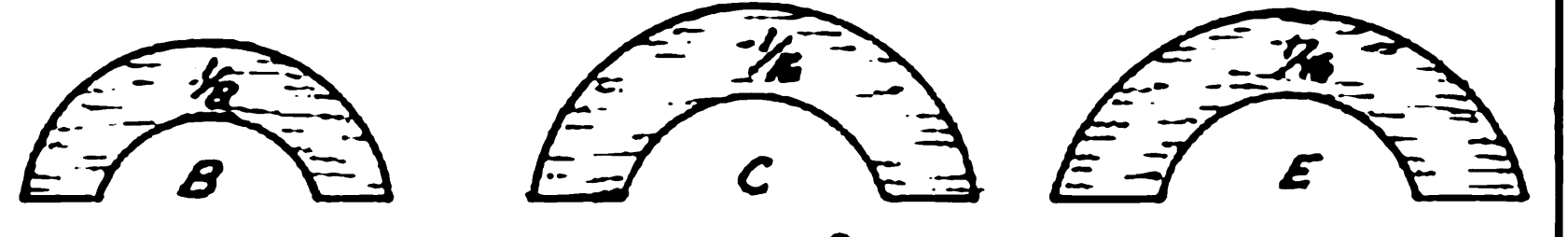
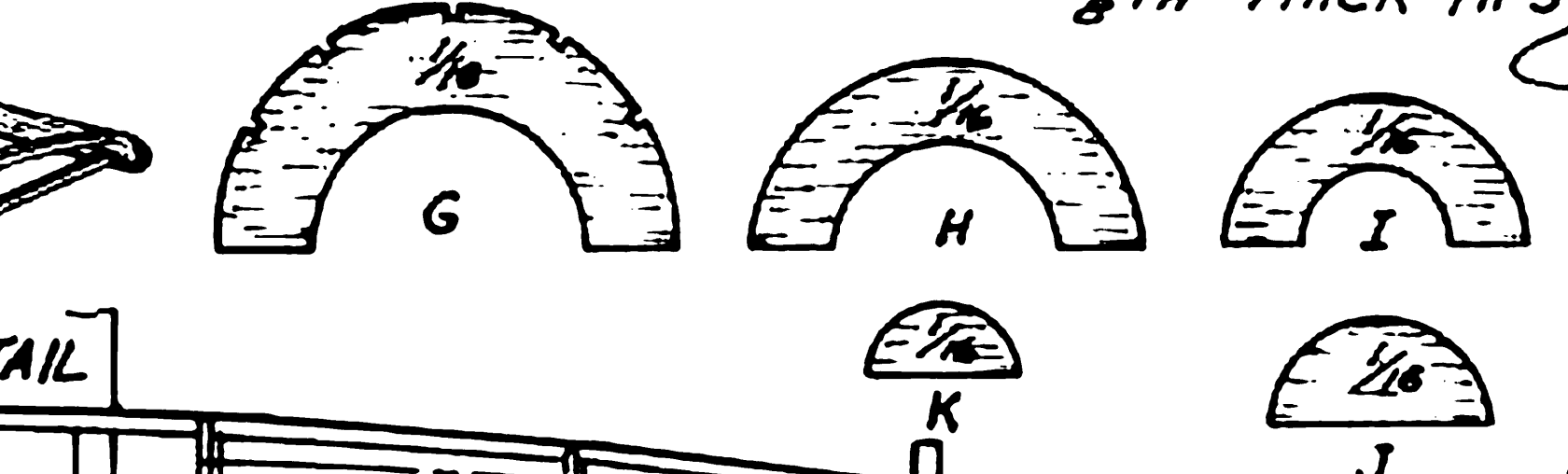
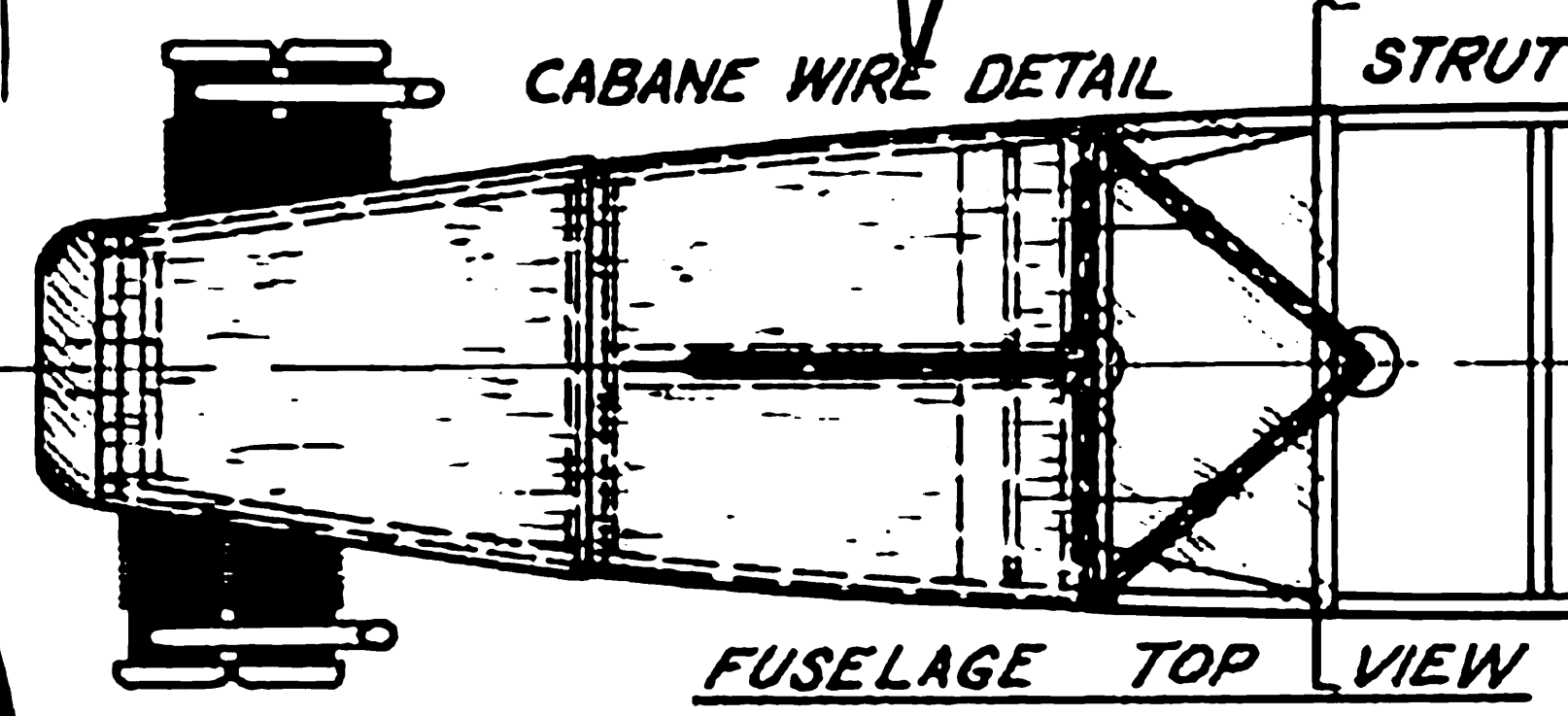

SLICED RIB TOP CAP - 1/16 TH SHEET
RIB BOTTOM CAP - 1/16 TH SQUARE

1/2 SHEET

1/16 SHEET TOP AND SIDES

D & F LAMINATED WINDSHIELD BOWS

11 1/16 TOP WING DIHEDRAL

VERTICAL TAIL PARTS ARE SAME SIZES AS HORIZONTAL TAIL

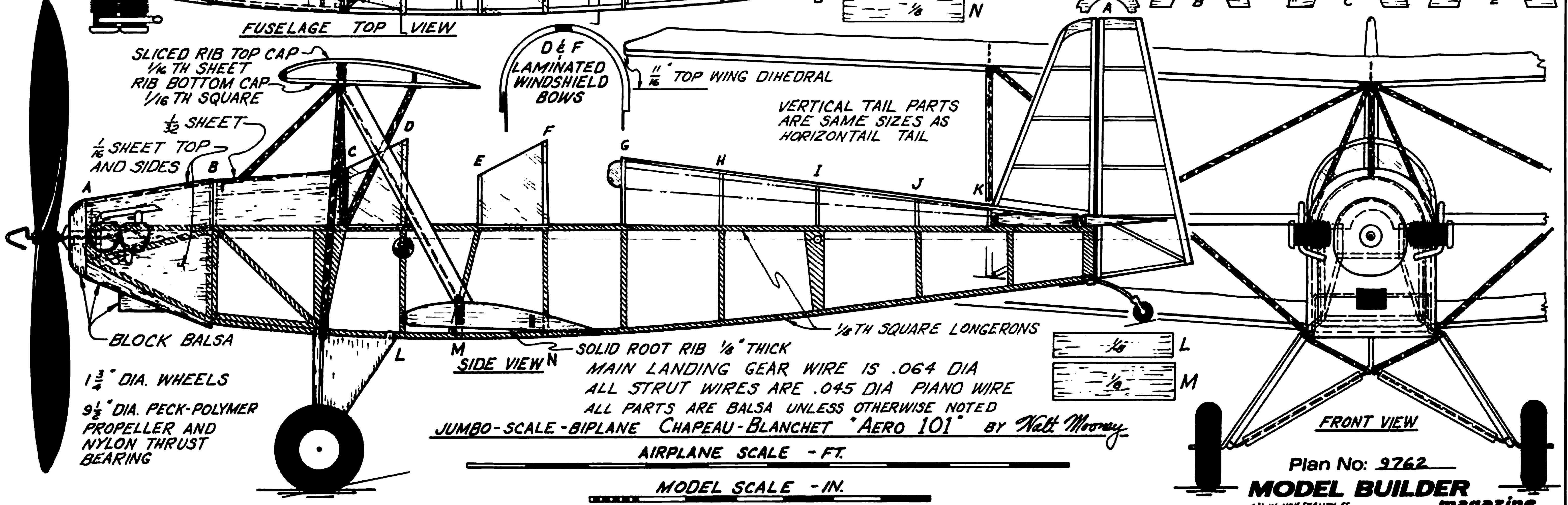

BLOCK Balsa

1 3/4 DIA. WHEELS

9 1/2 DIA. PECK-POLYMER PROPELLER AND NYLON THRUST BEARING

SIDE VIEW

SOLID ROOT RIB 1/8 THICK
MAIN LANDING GEAR WIRE IS .064 DIA
ALL STRUT WIRES ARE .045 DIA PIANO WIRE
ALL PARTS ARE Balsa UNLESS OTHERWISE NOTED

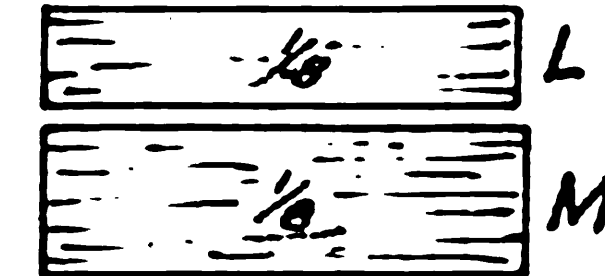

JUMBO-SCALE-BIPLANE CHAPEAU-BLANCHET "AERO 101" by *Nalt Mooney*

AIRPLANE SCALE - FT.

MODEL SCALE - IN.

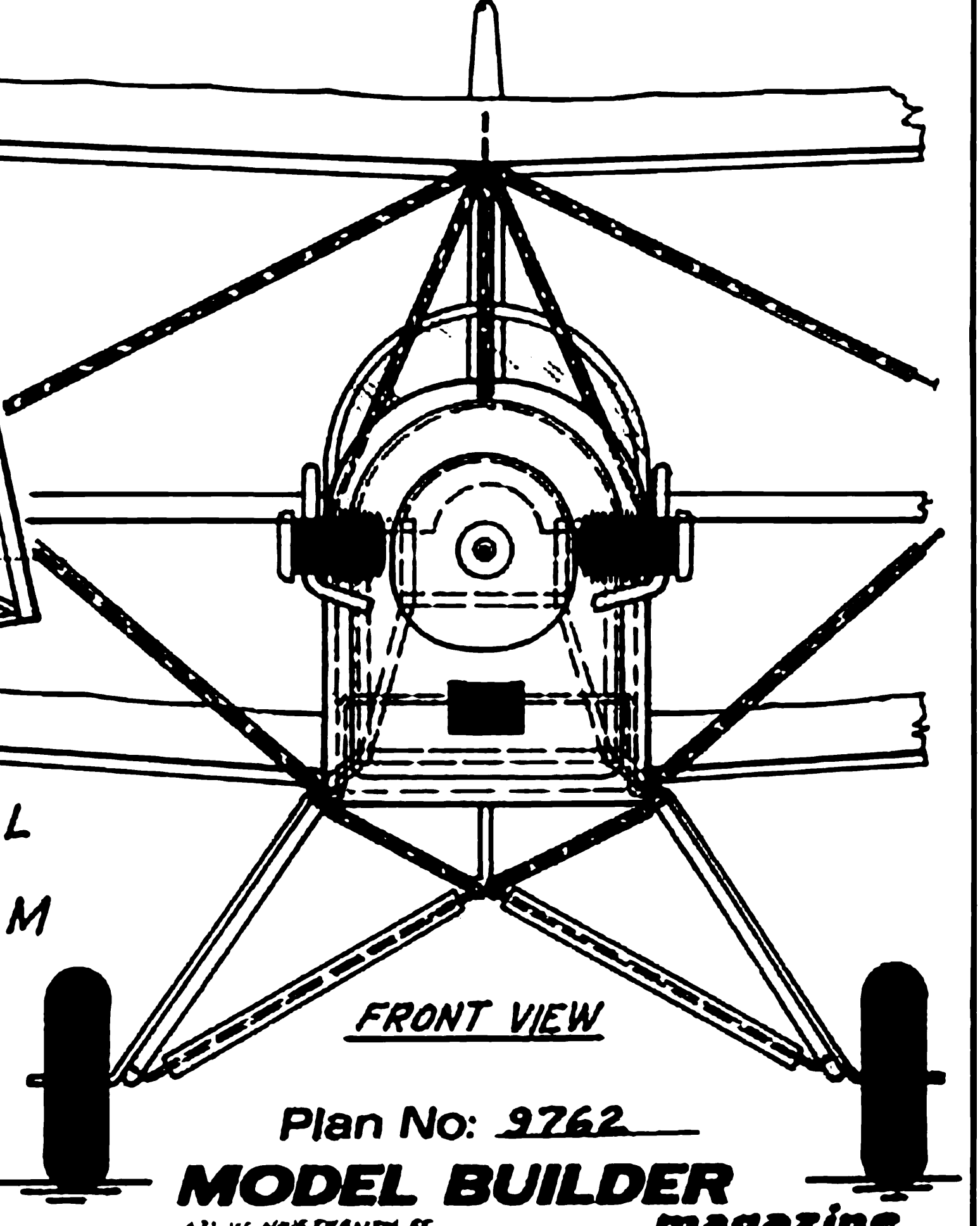

Plan No: 9762

MODEL BUILDER magazine

631 W. MAINTENANCE ST
COSTA MESA, CALIF. 92627