

Spar Slot for 1mmx3

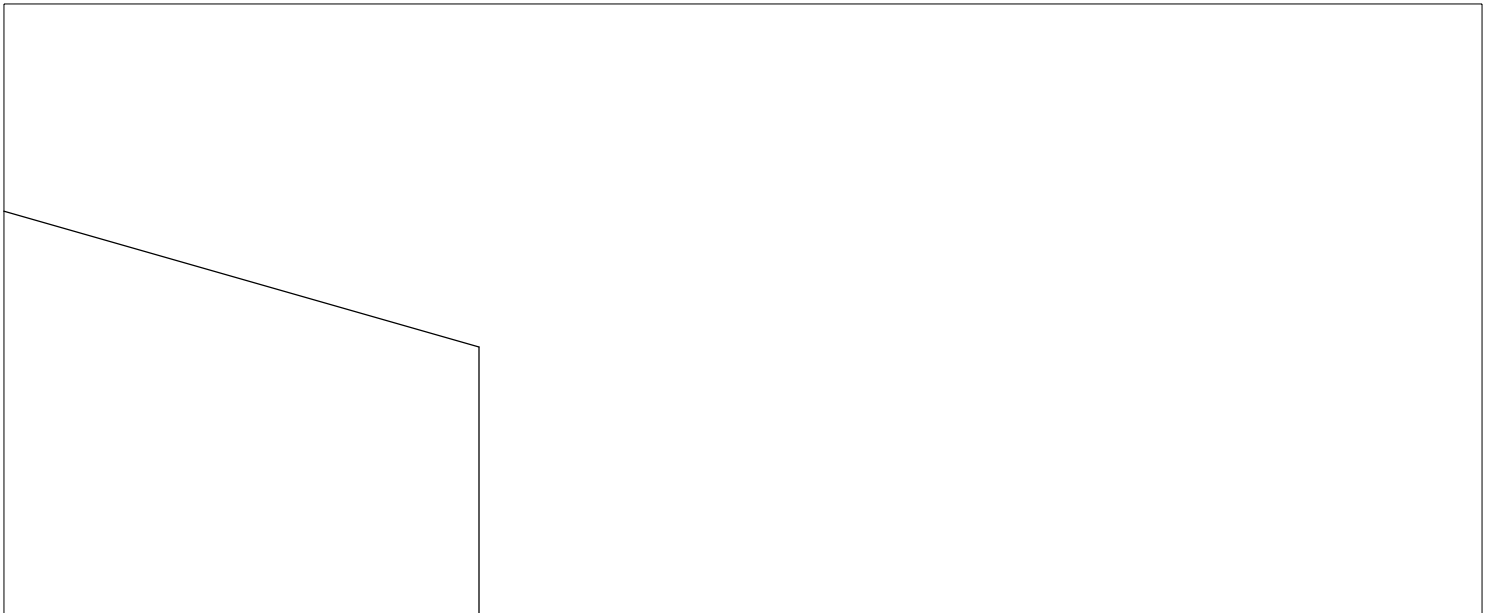

3mm Flat Carbon Spar

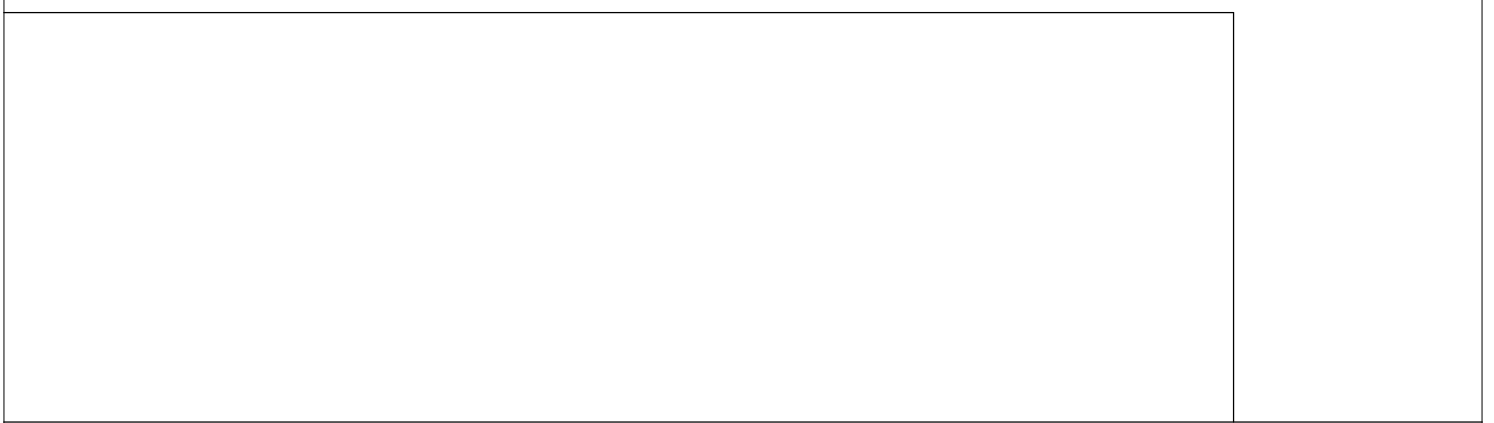

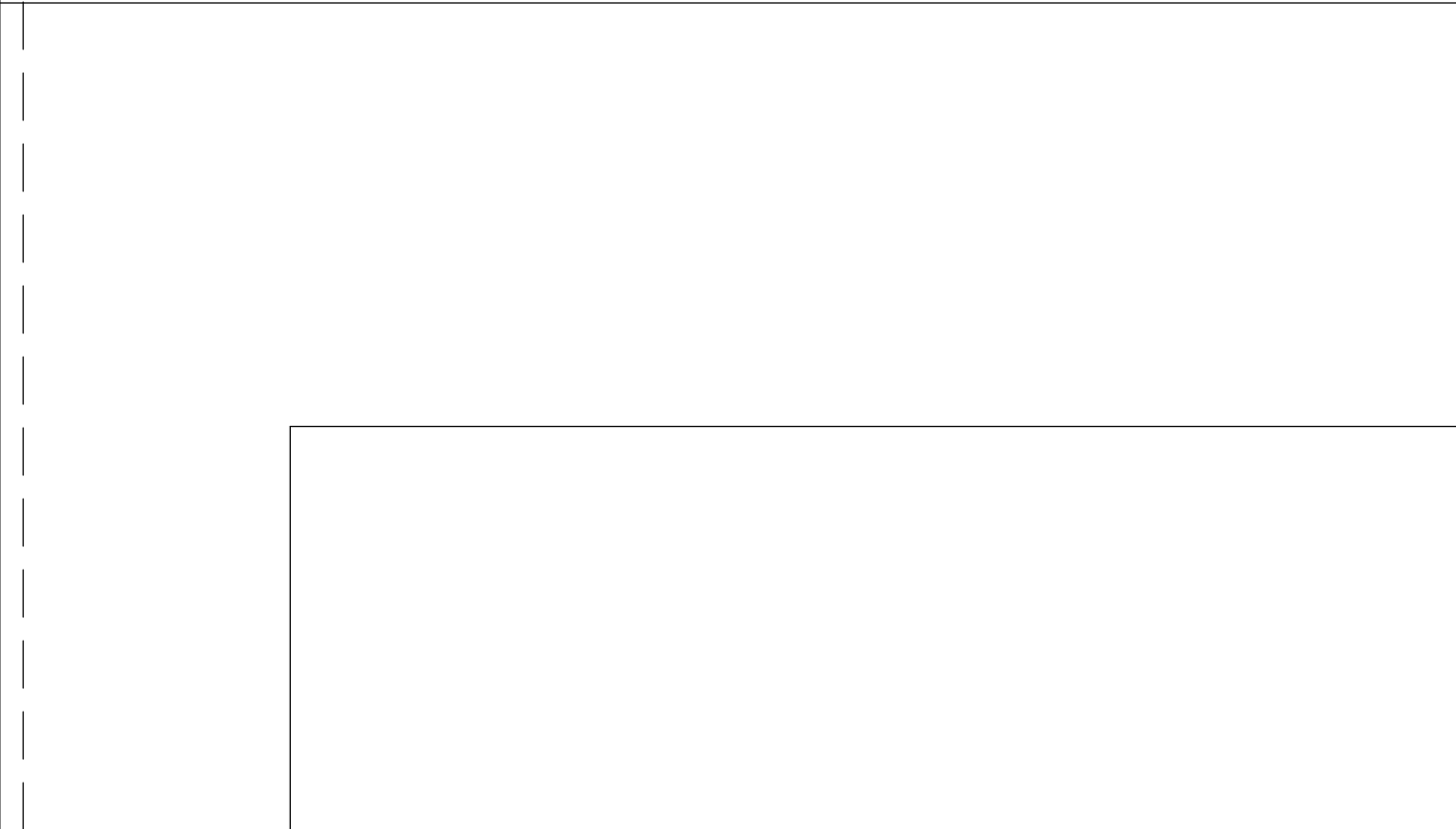
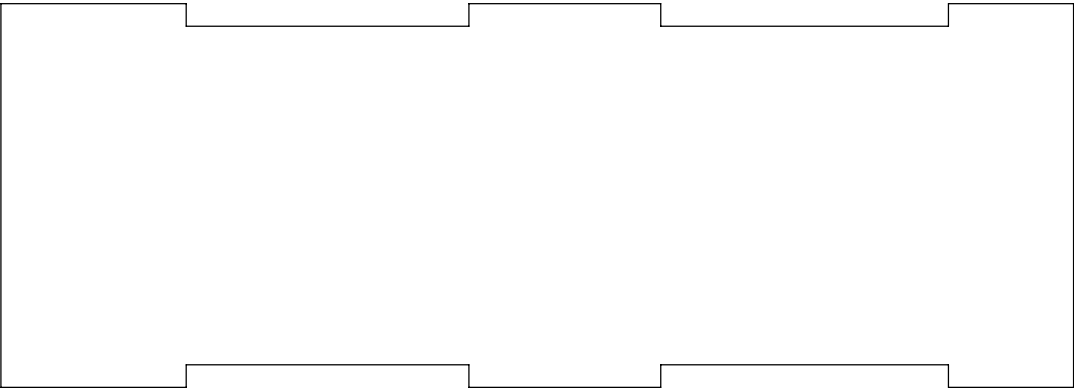

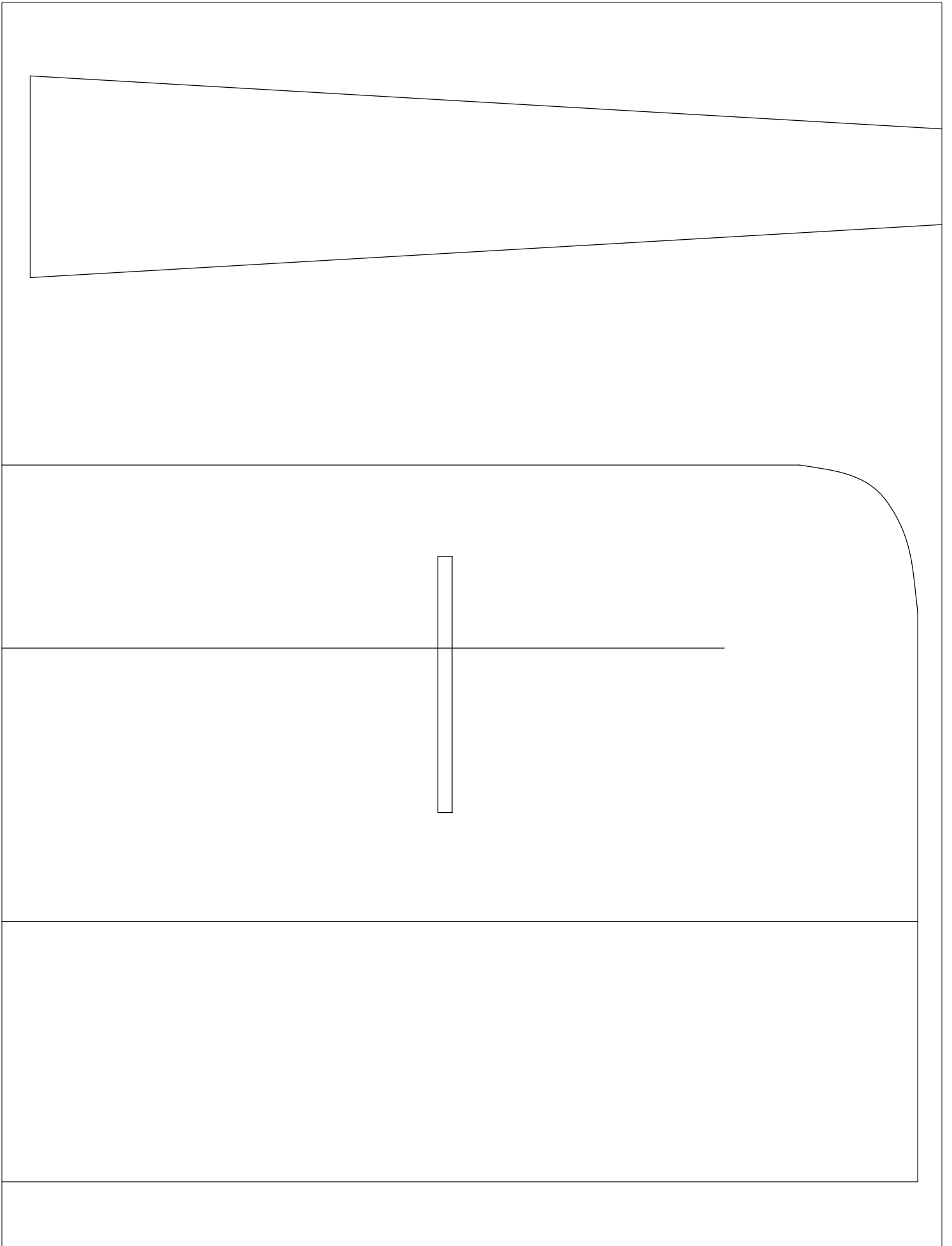

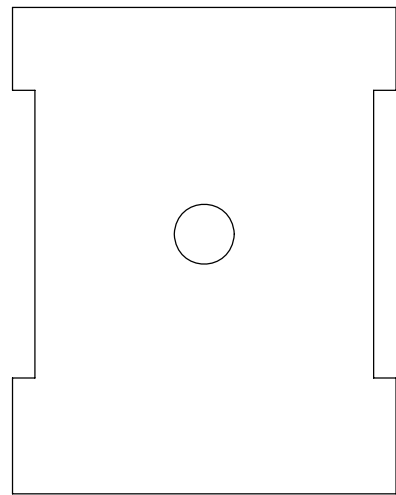
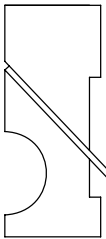
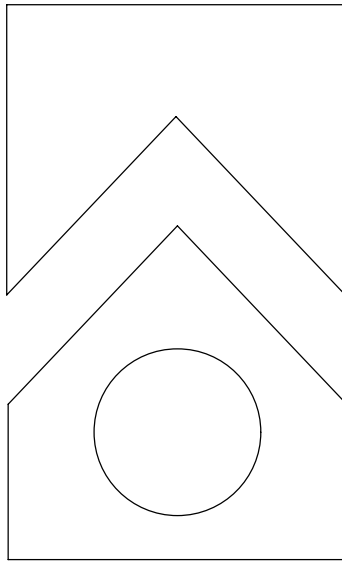
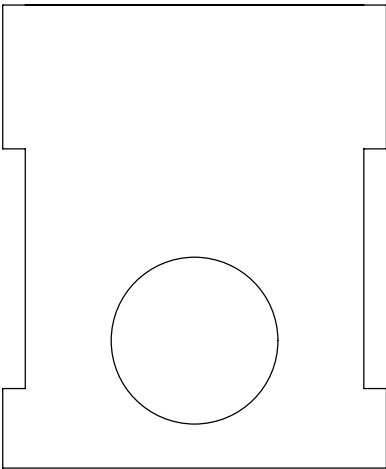
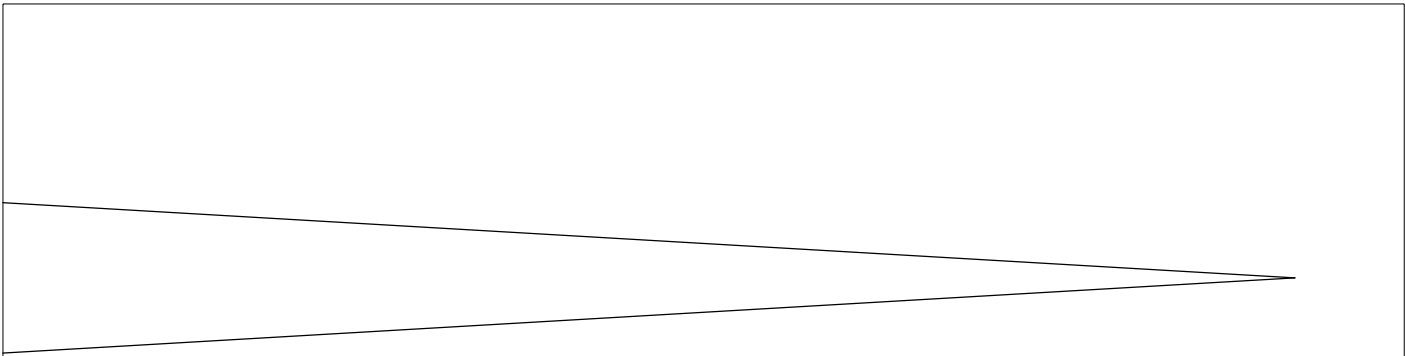

1/8" Lite Ply Firewall

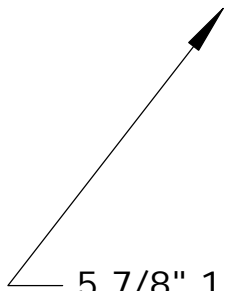

5 7/8" 1.5mm carbon rod gear leg

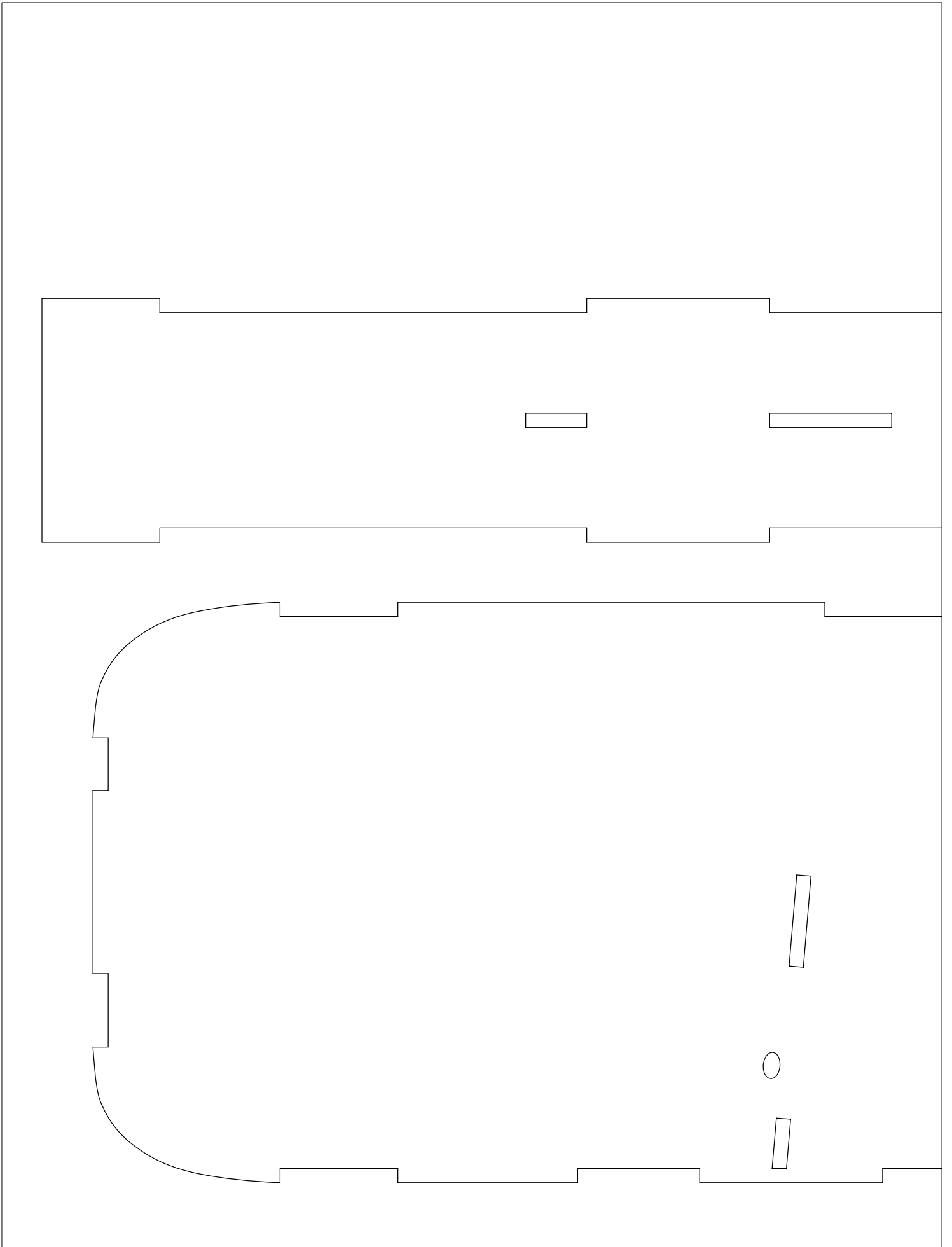

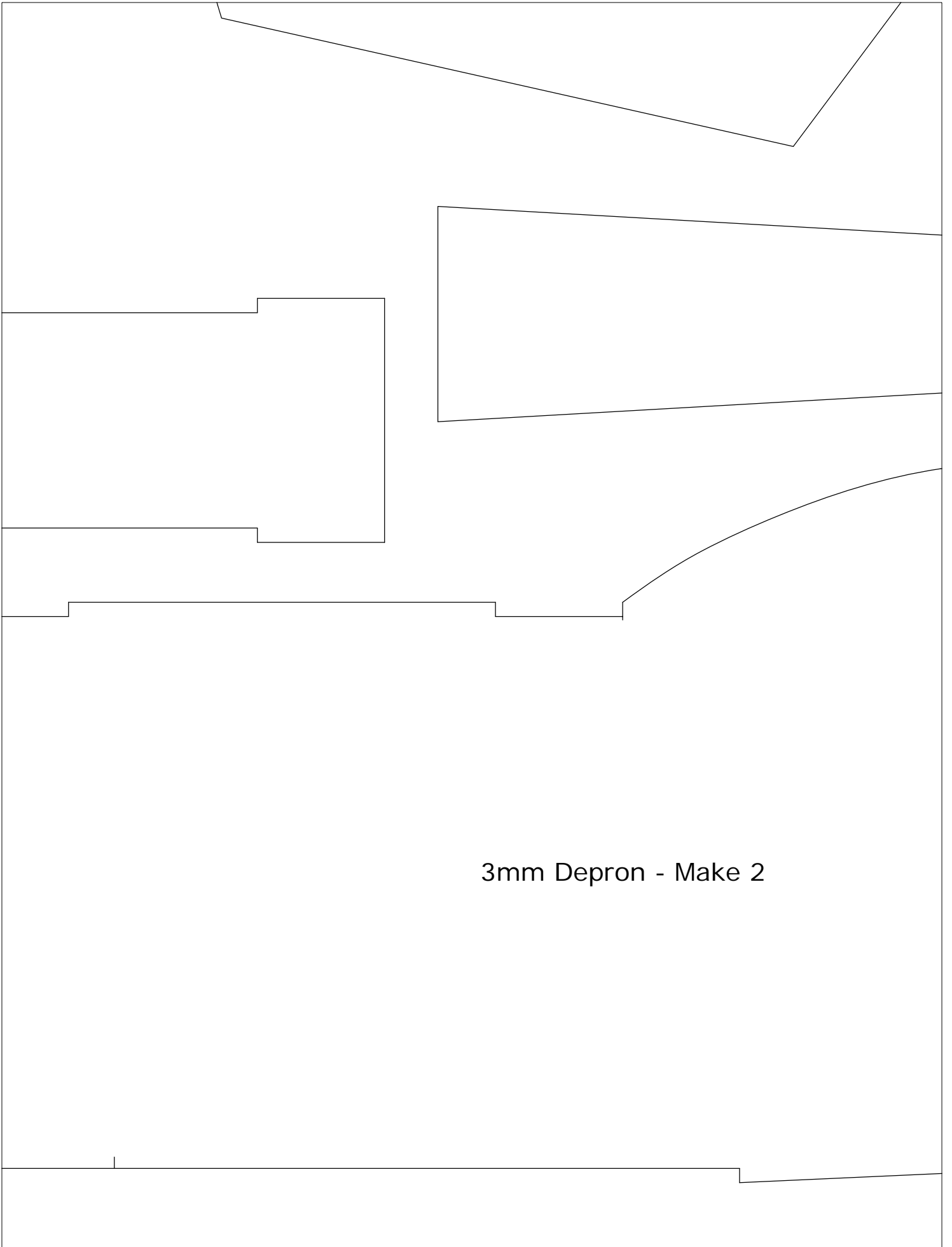

3mm Depron - Make 2



32" Pitts Python

3mm Depron - Make 2

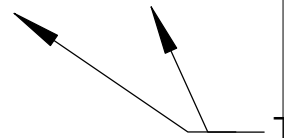
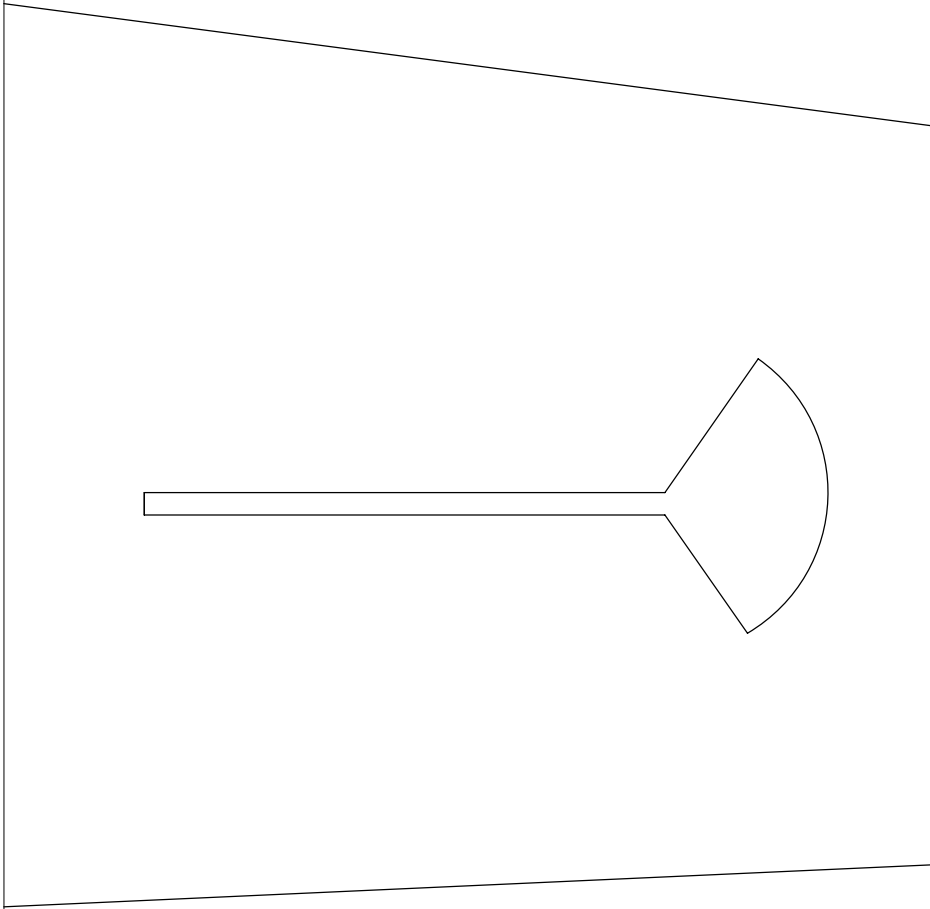
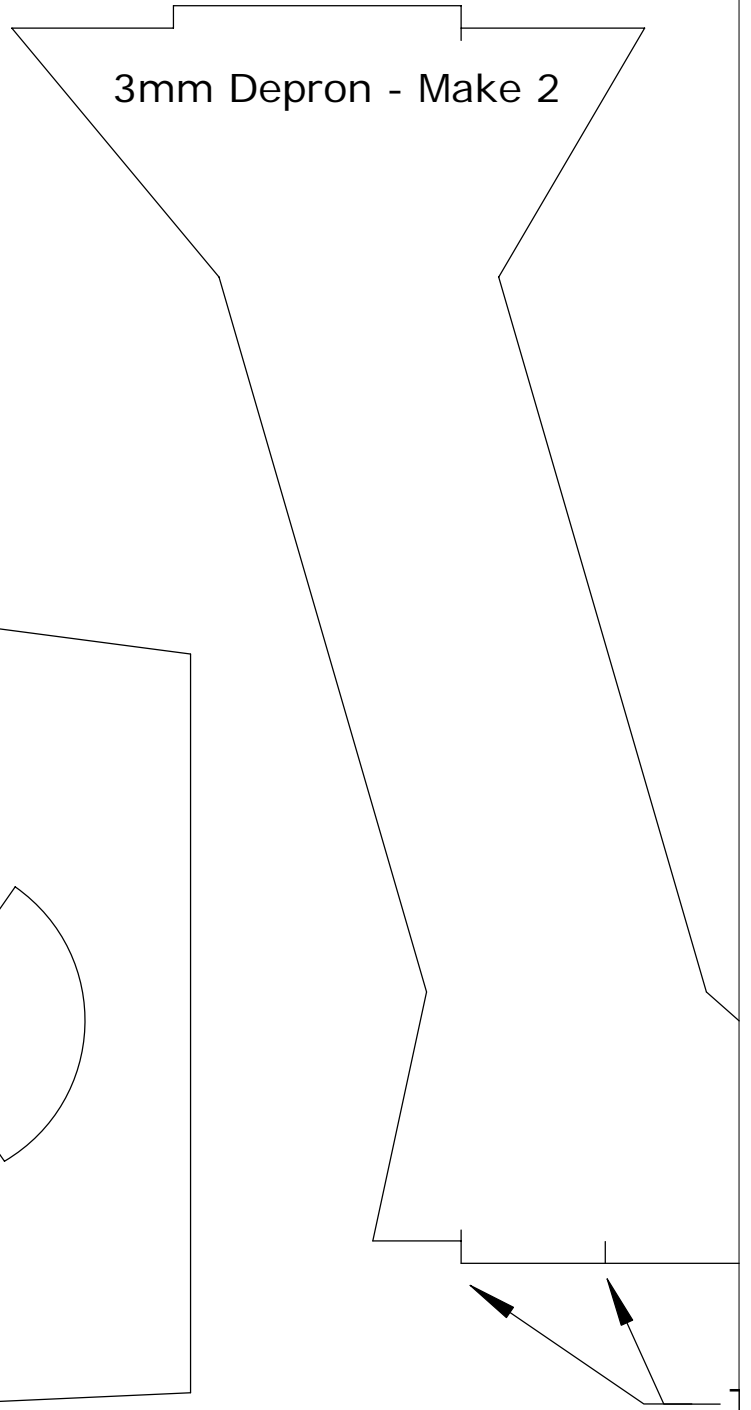
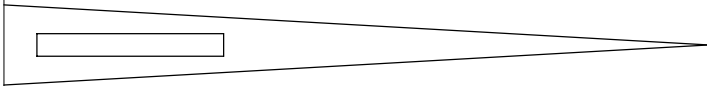

Nose Doubler



Top

3mm Depron - Make 2

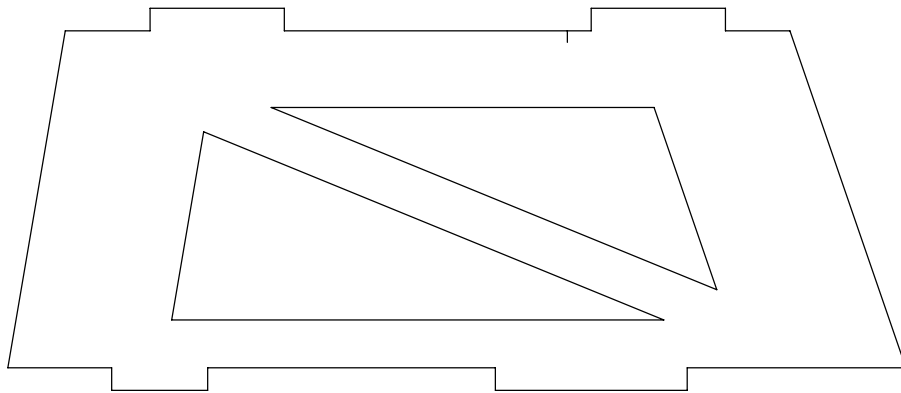

Tick marks (common) are for carbon placement

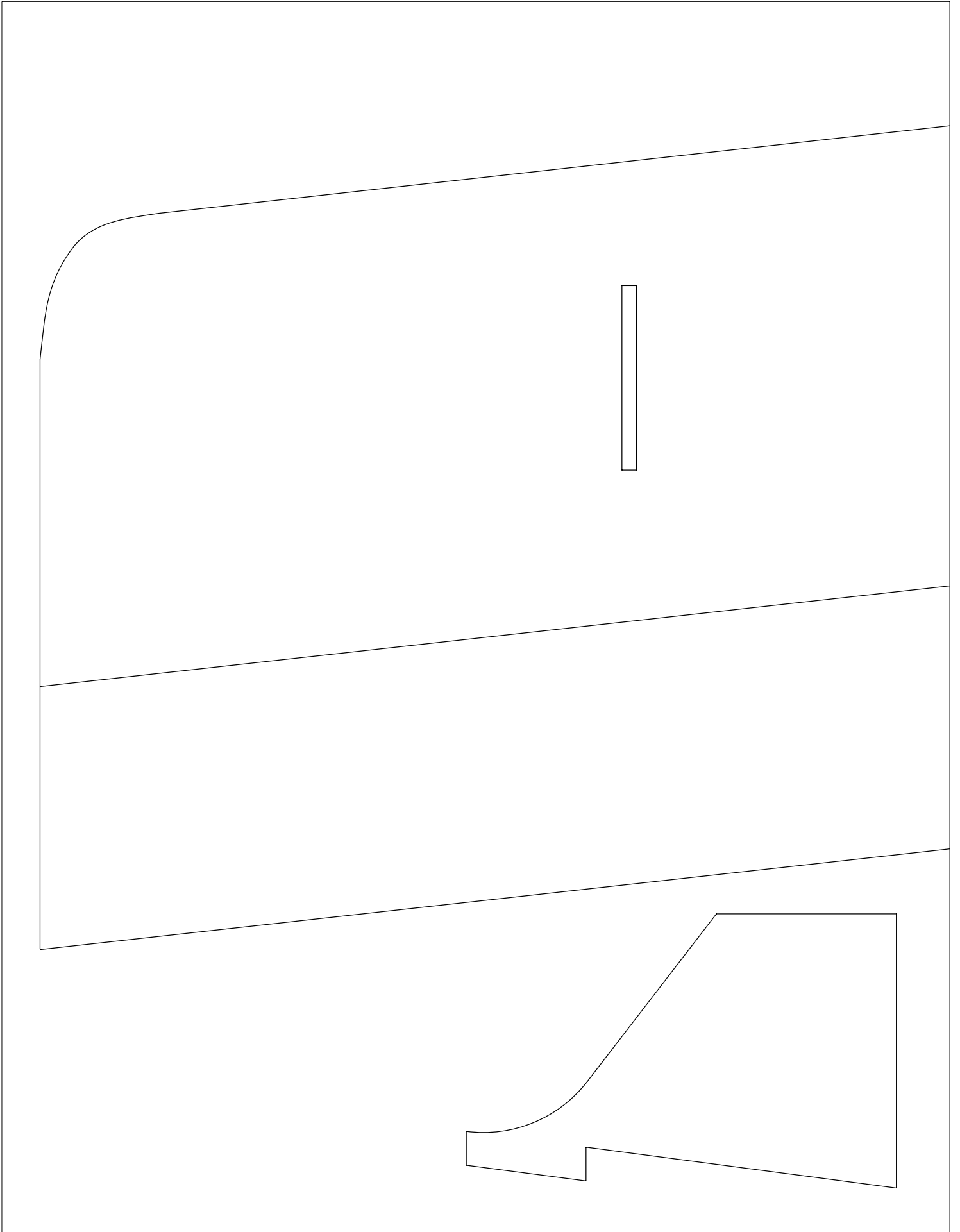

Both wings cut from a single piece of 3mm Depron

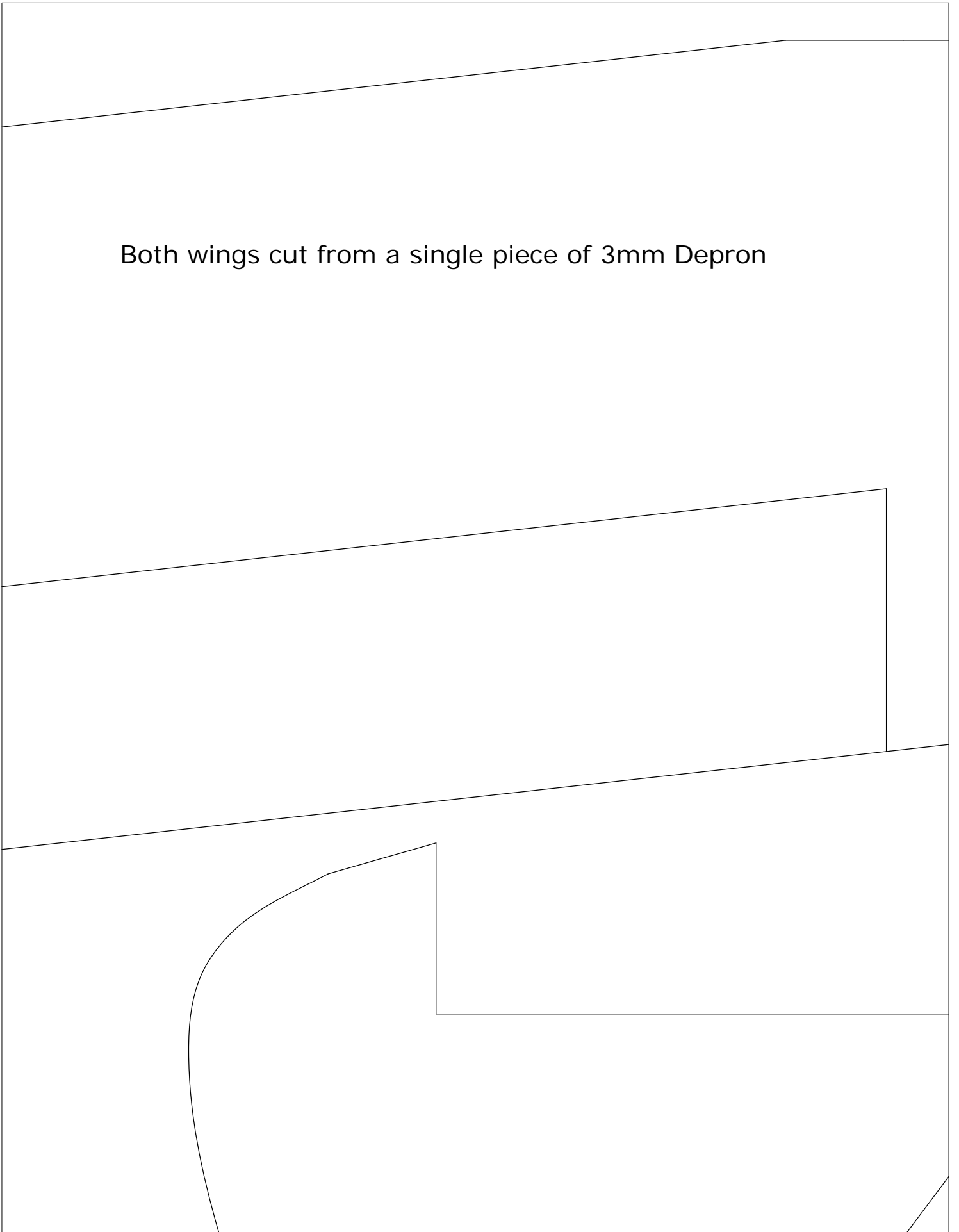

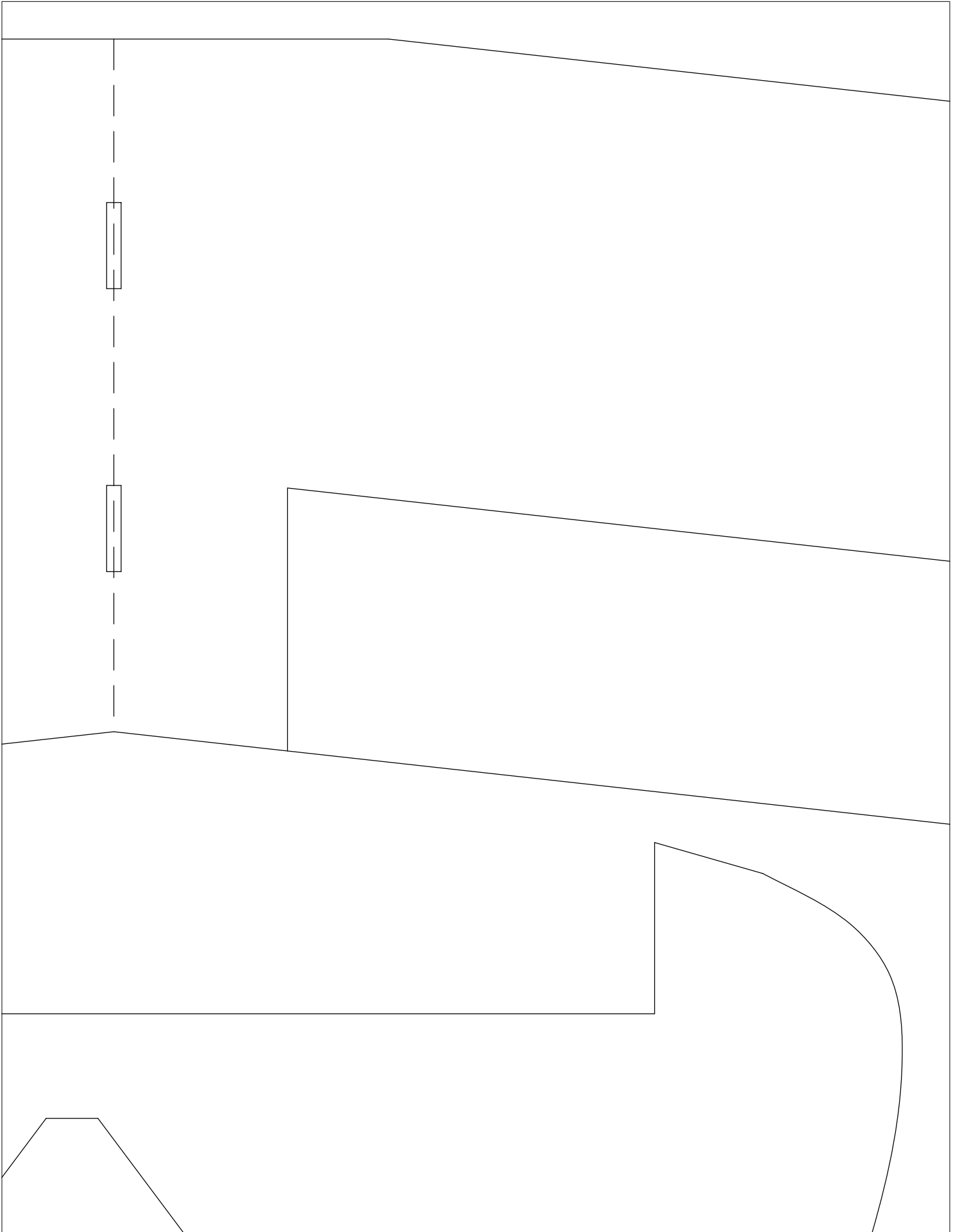

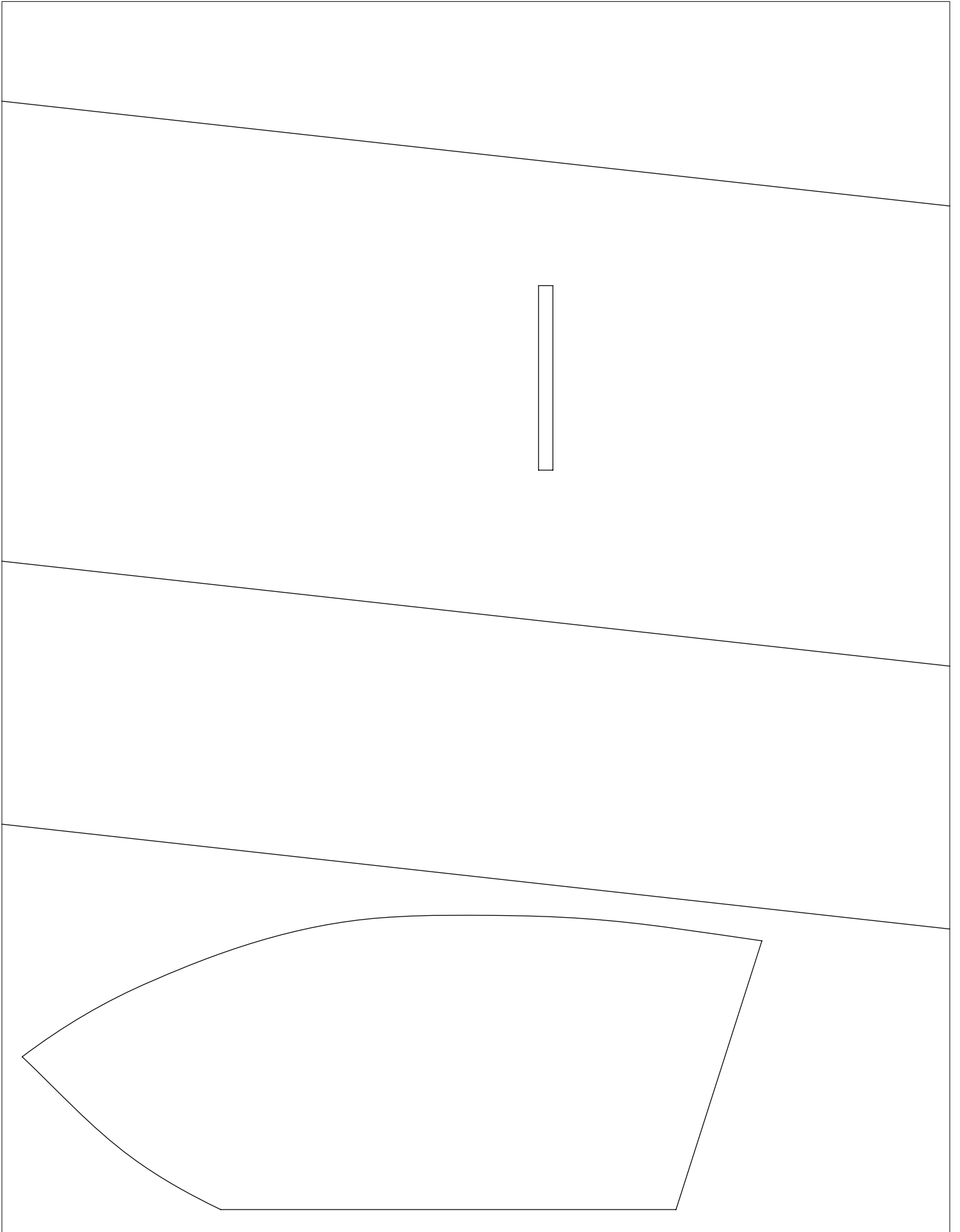

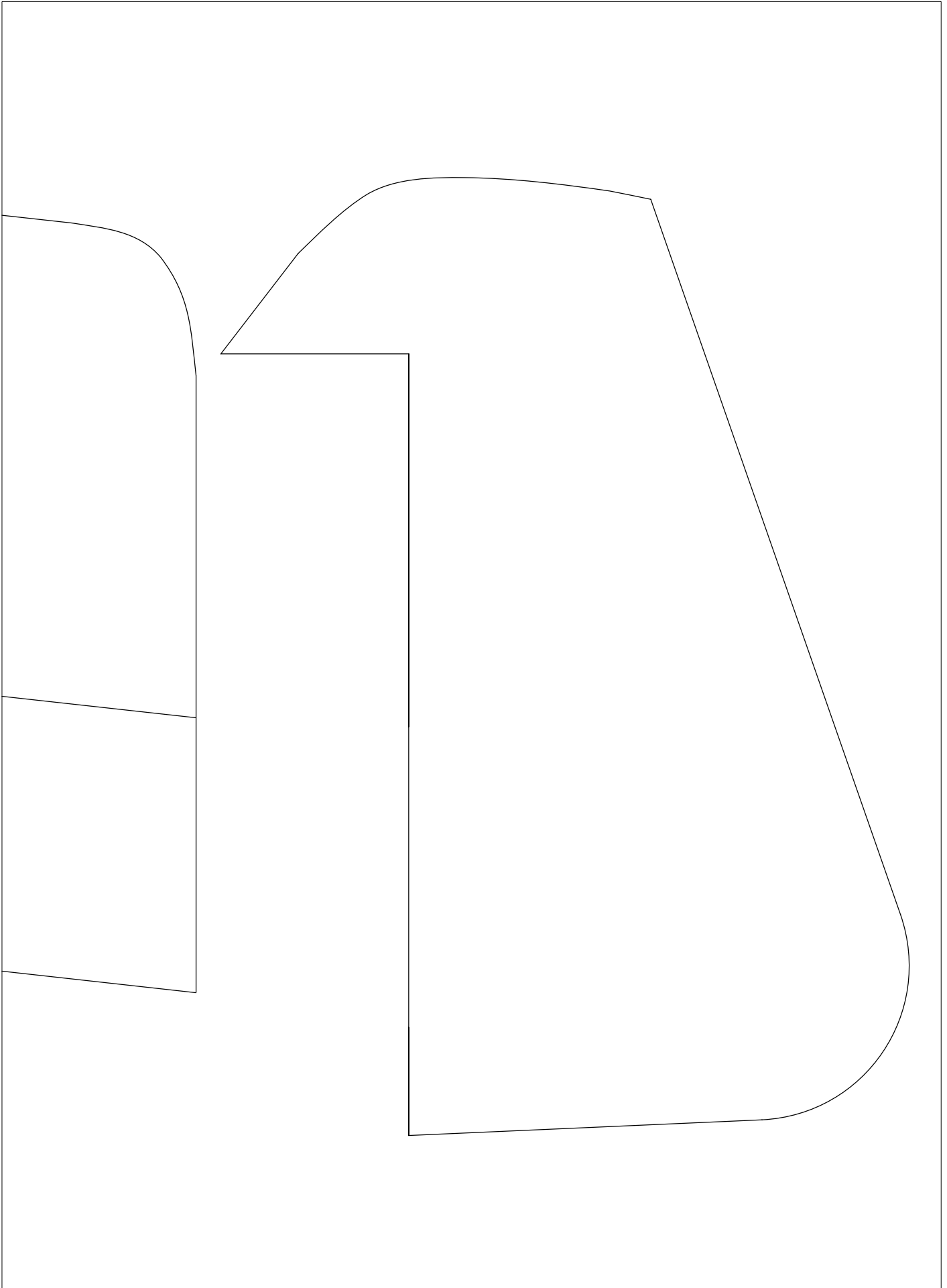

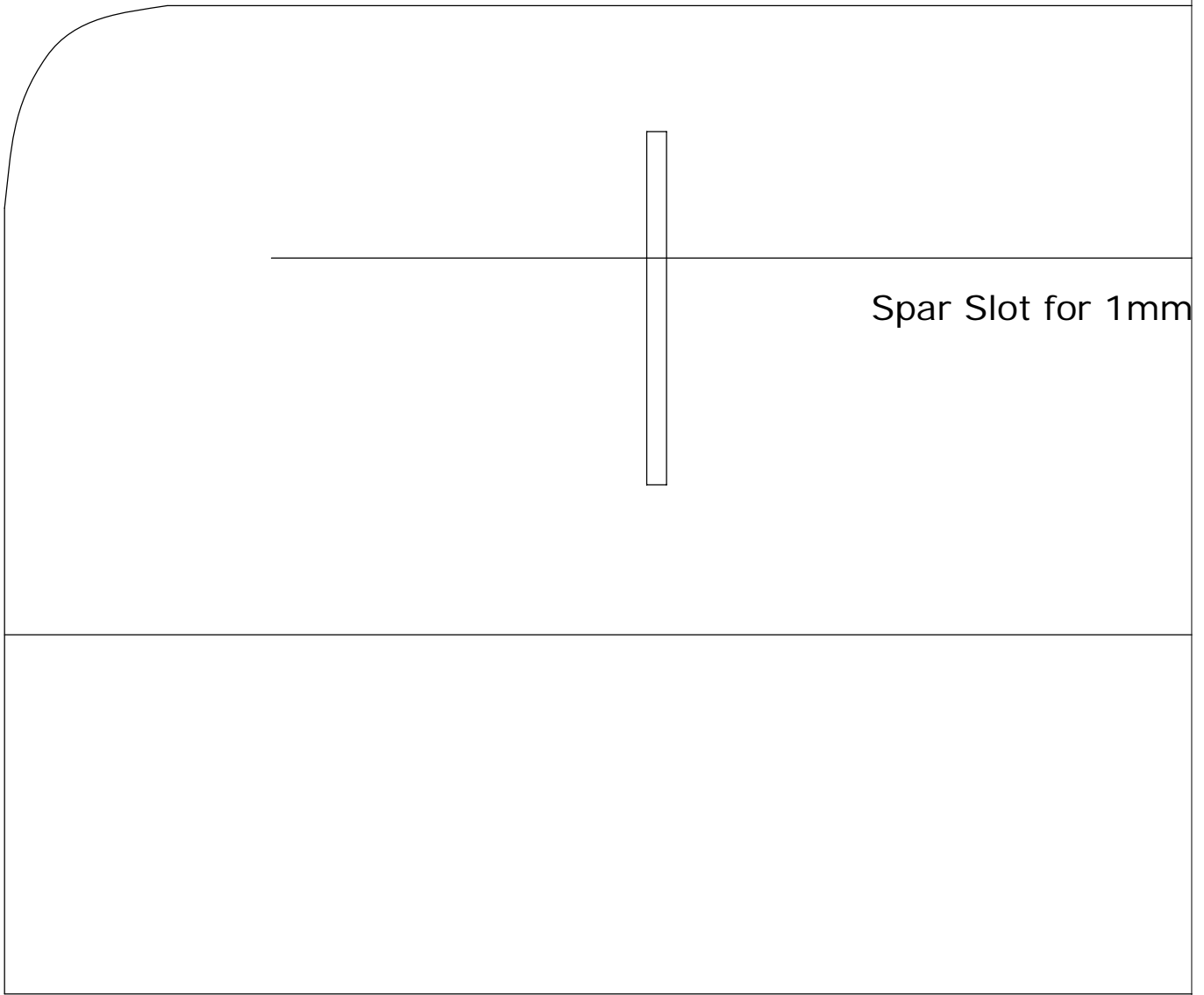
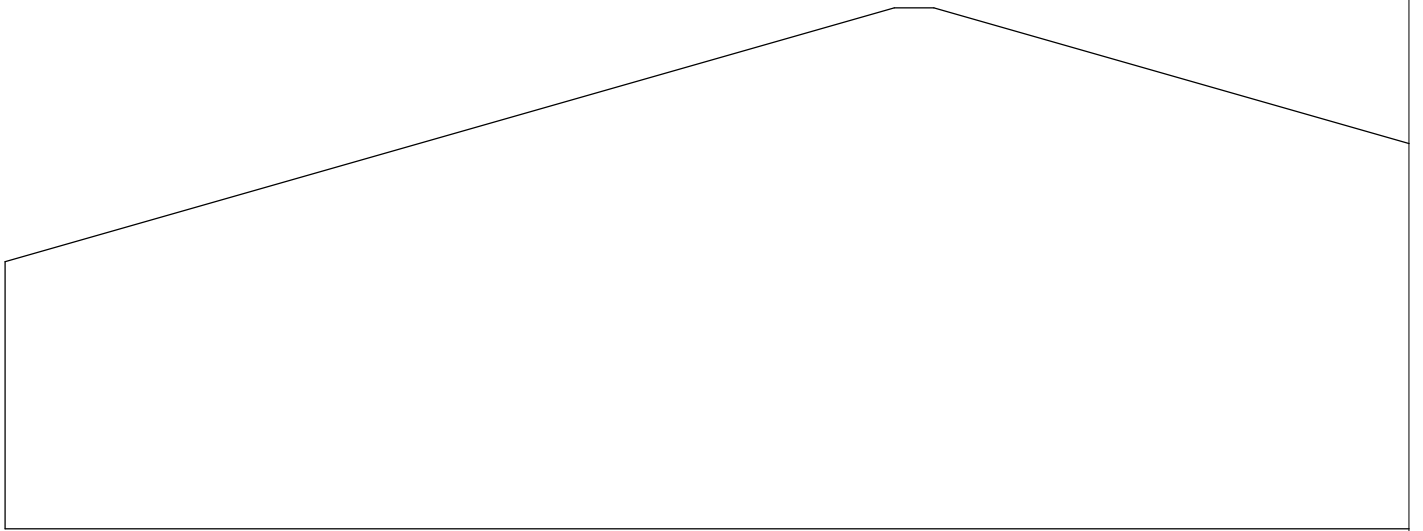

Spar Slot for 1mm

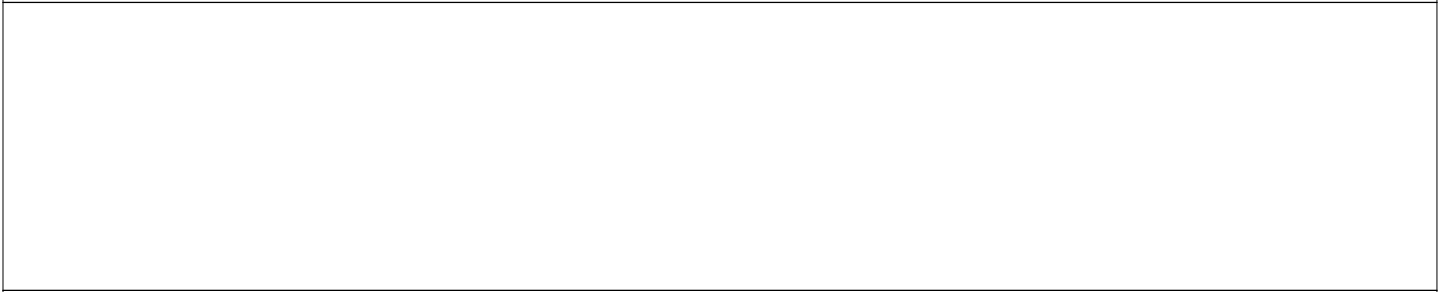
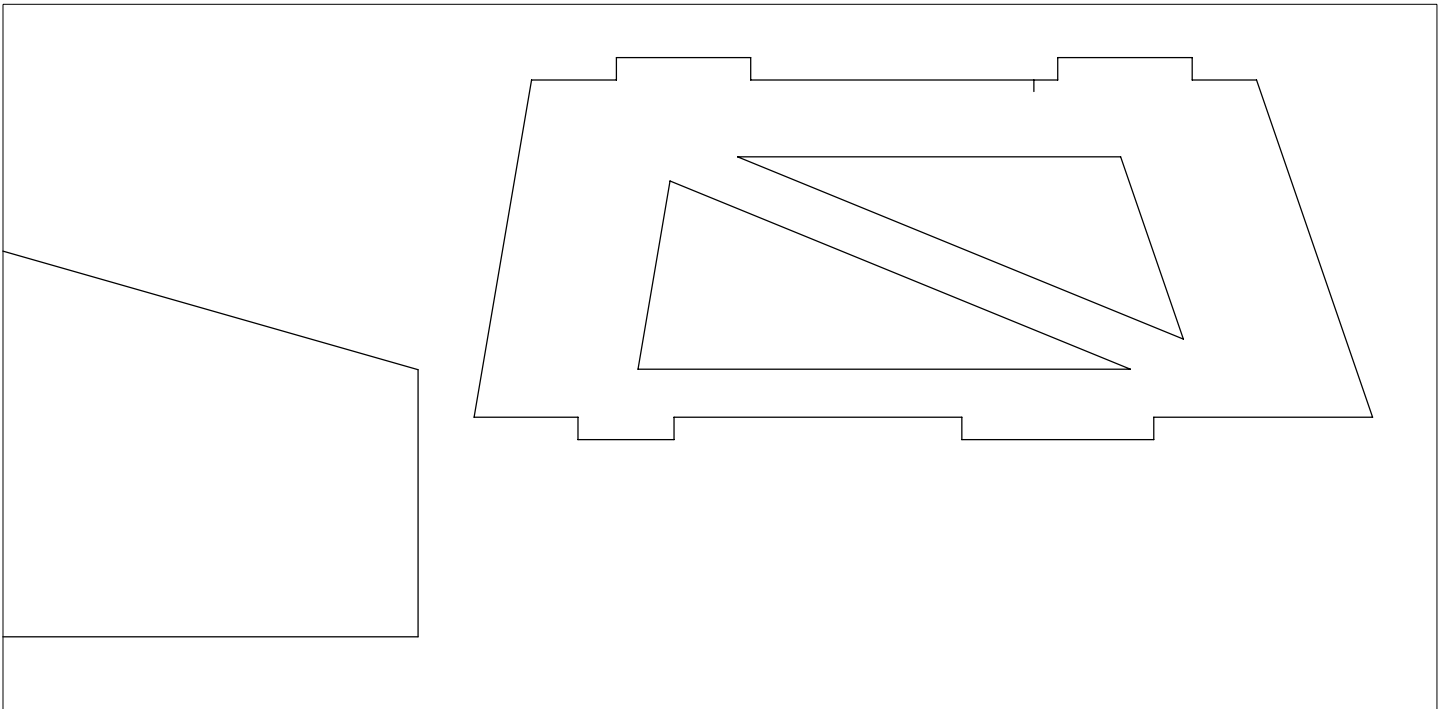

x3mm Flat Carbon Spar



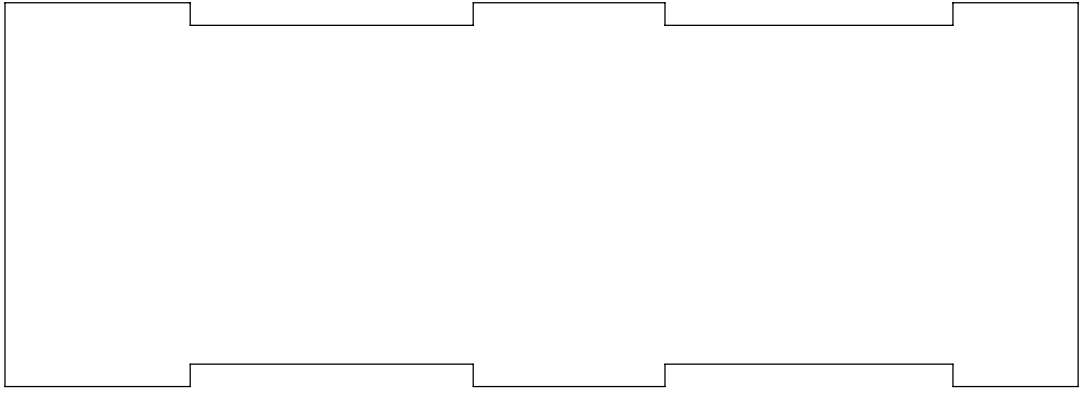

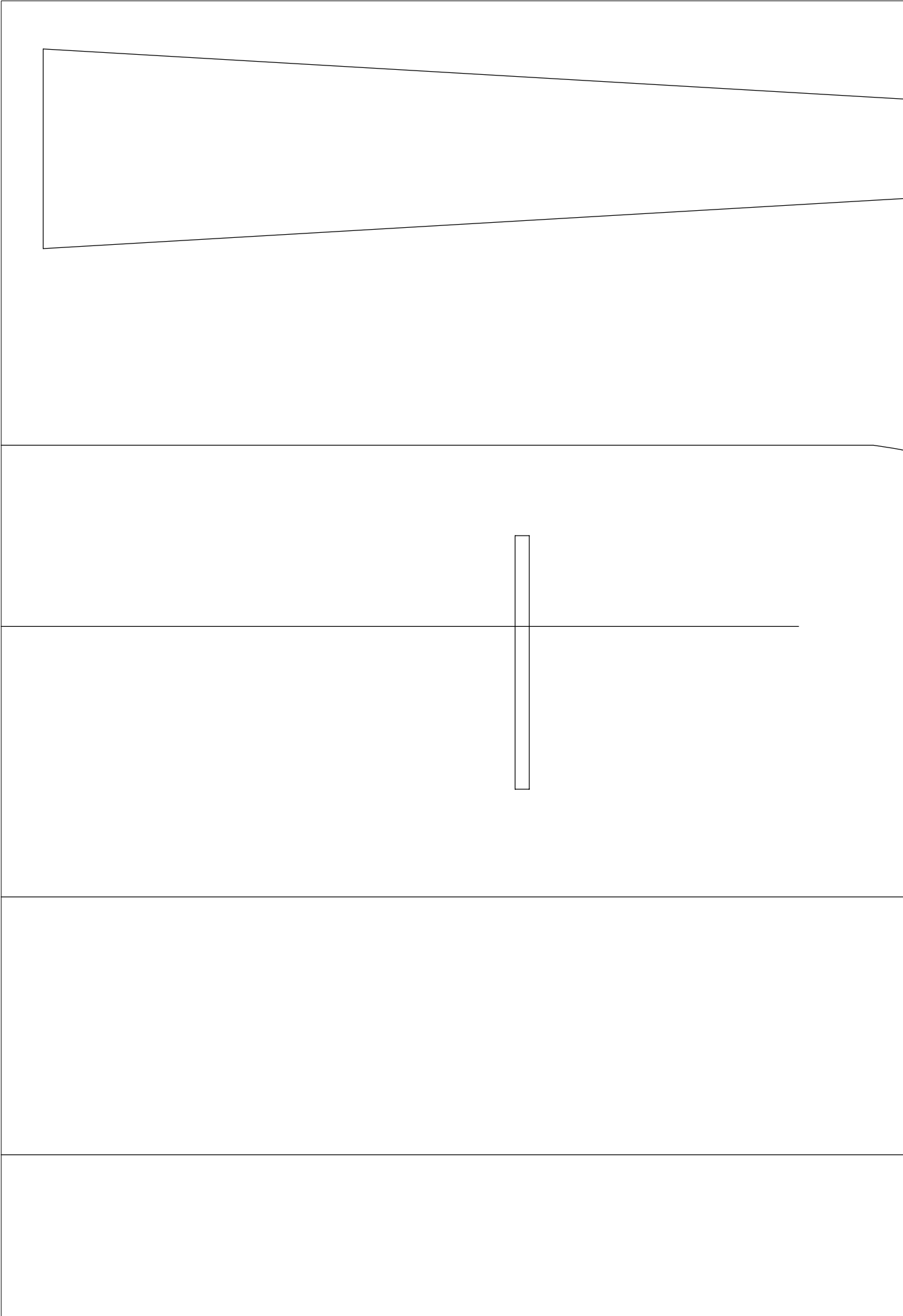

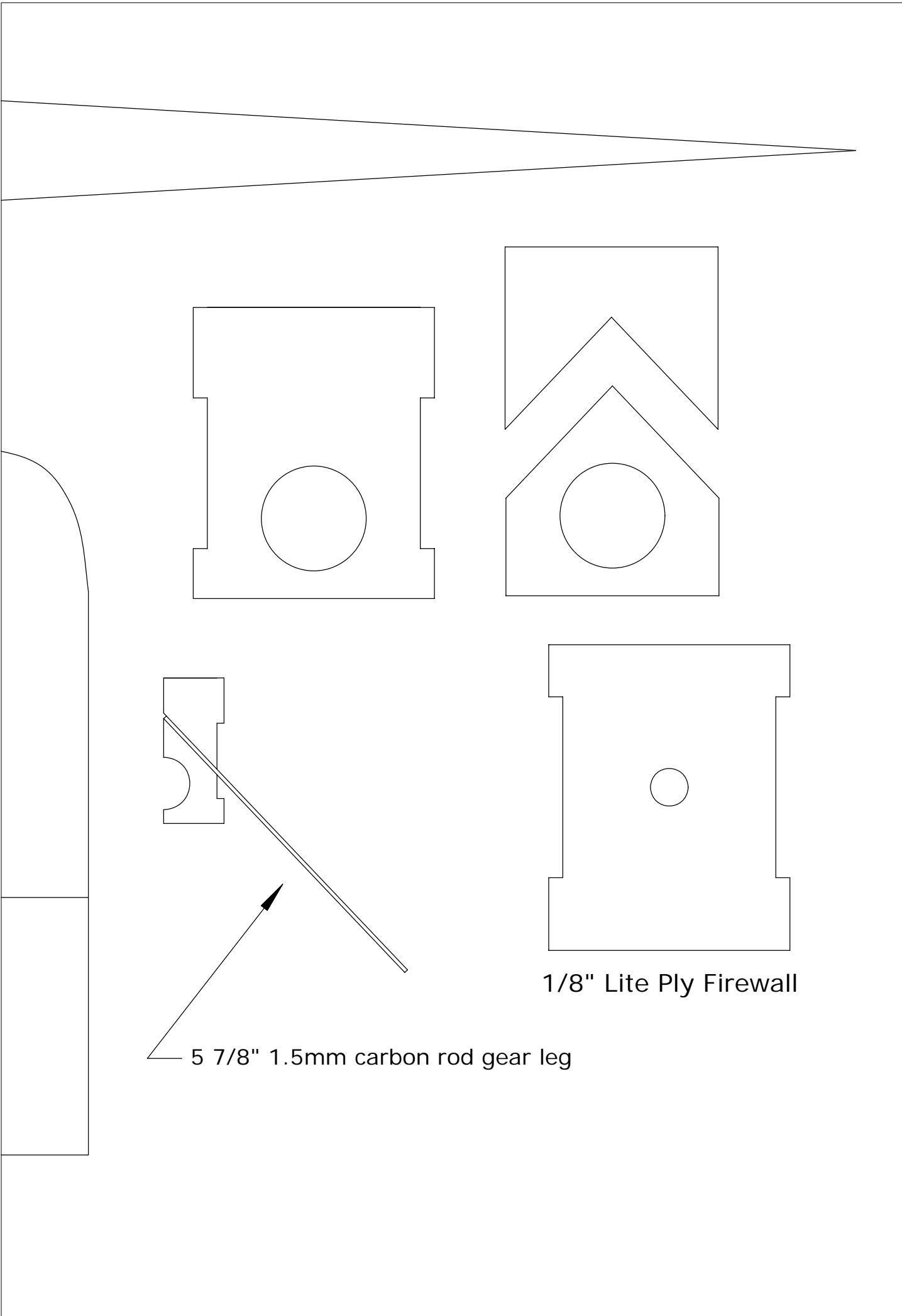

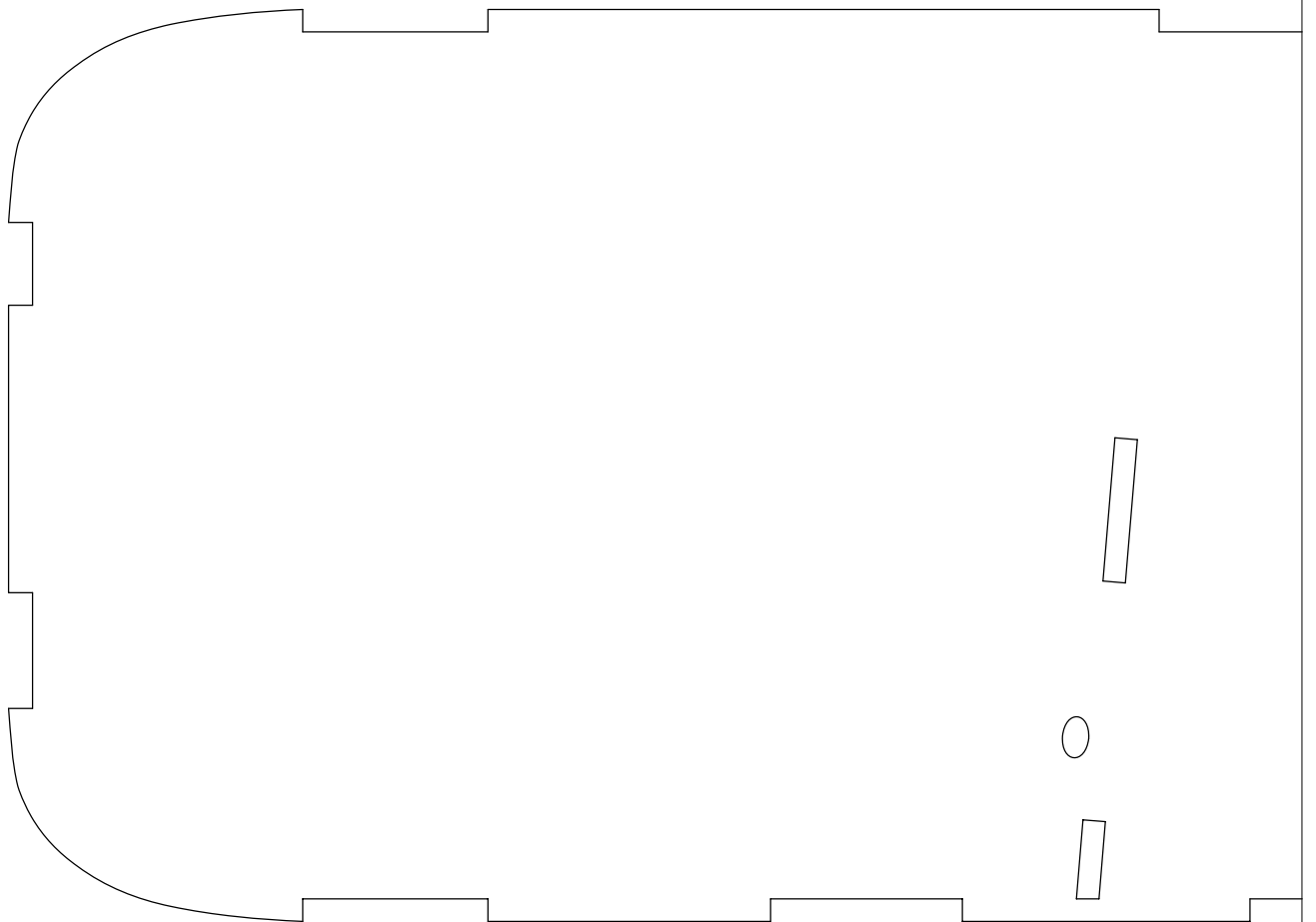
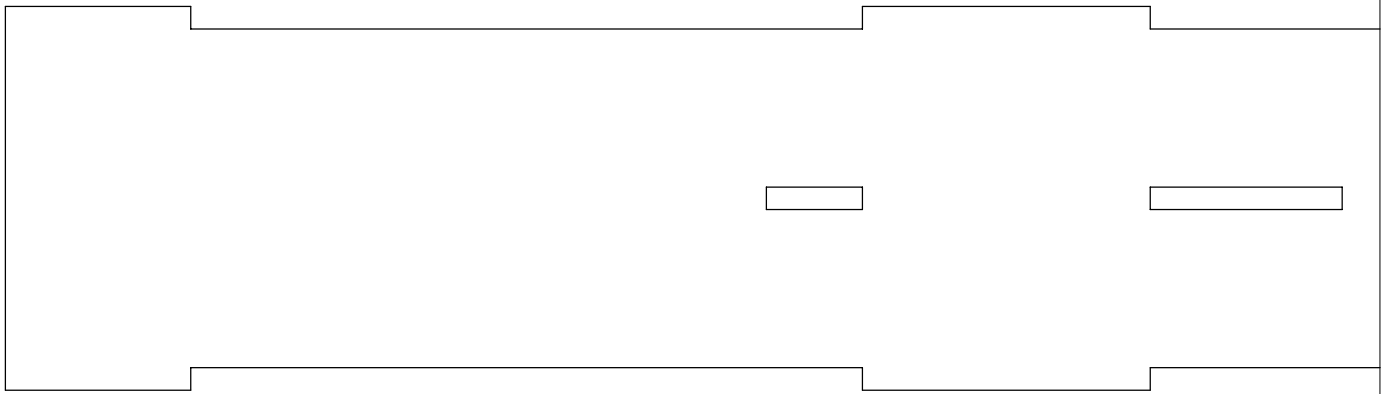
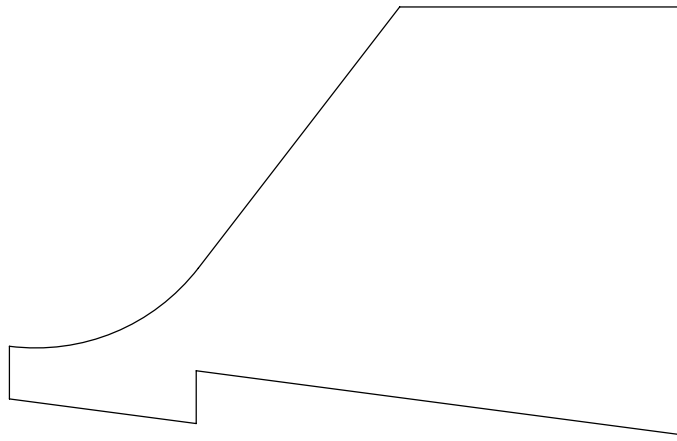

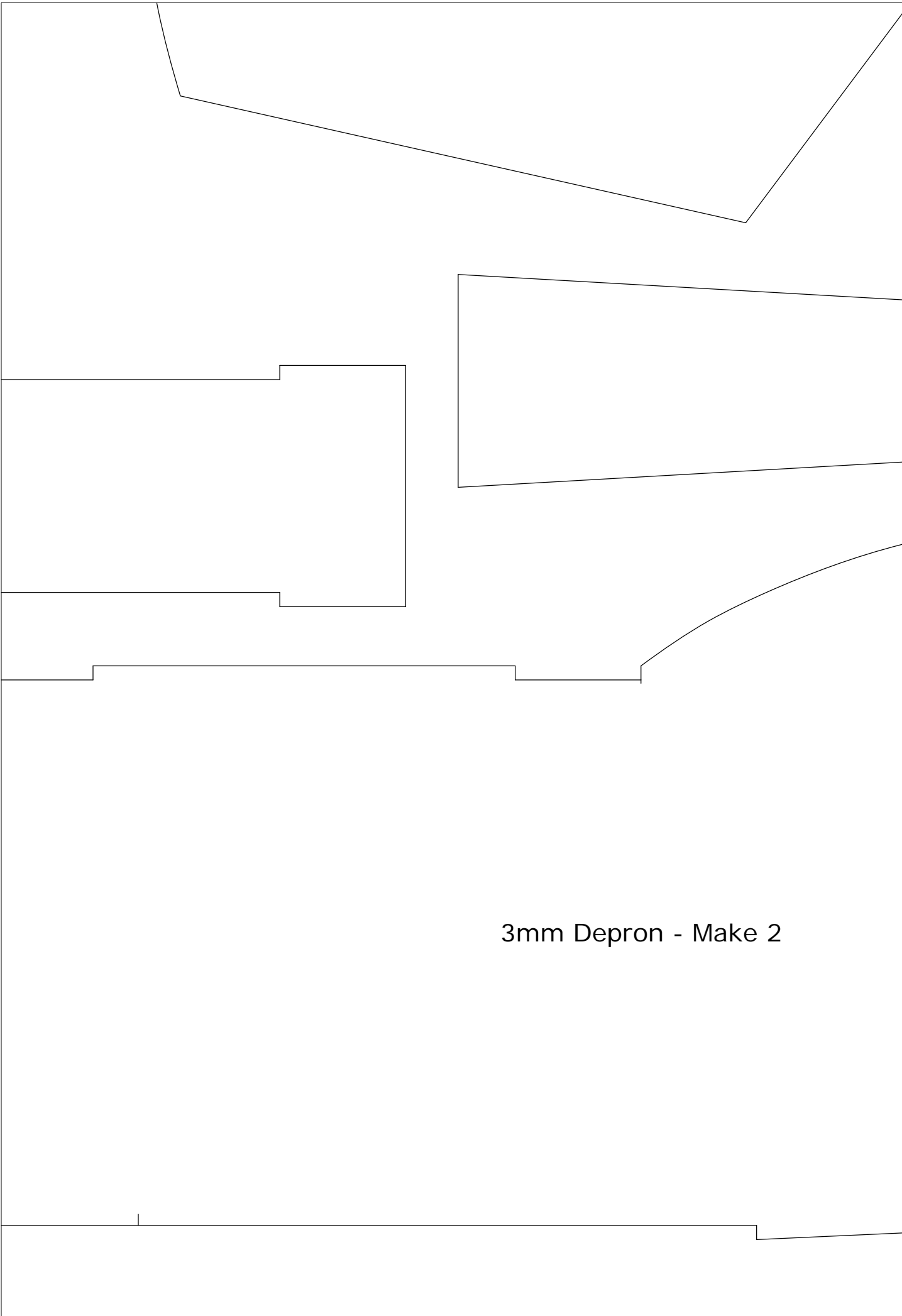

3mm Depron - Make 2



32" Pitts Python

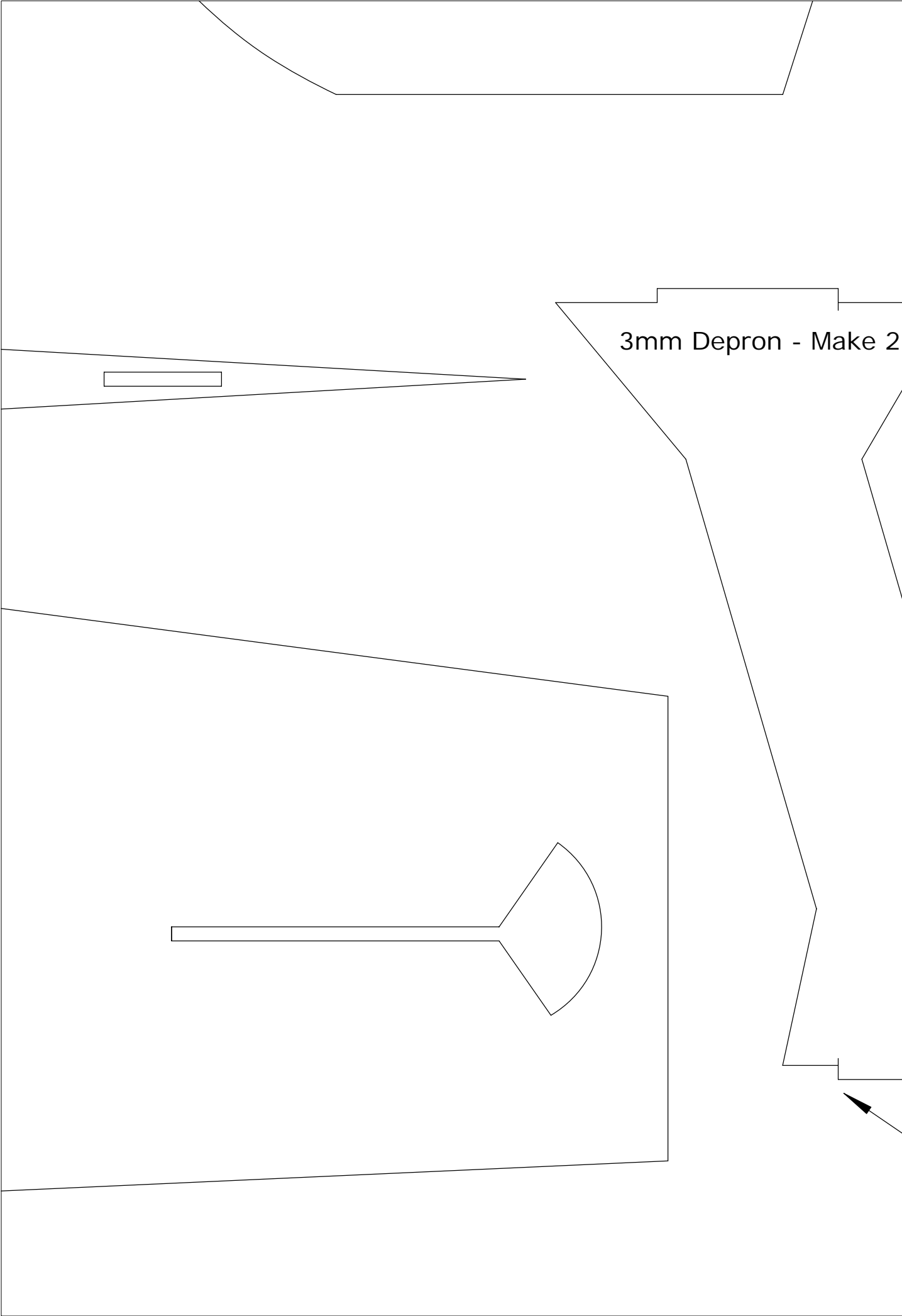

3mm Depron - Make 2

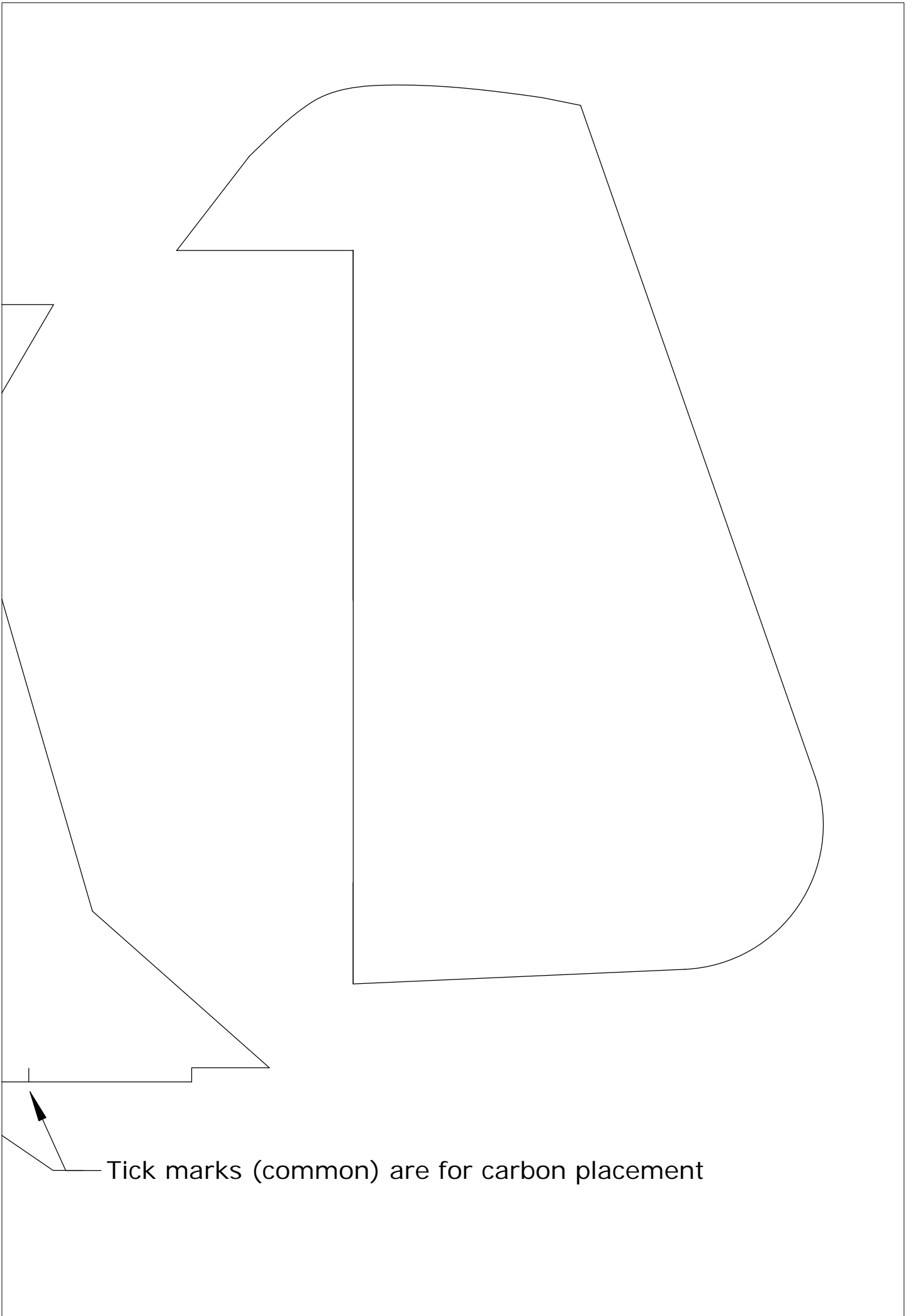

Tick marks (common) are for carbon placement

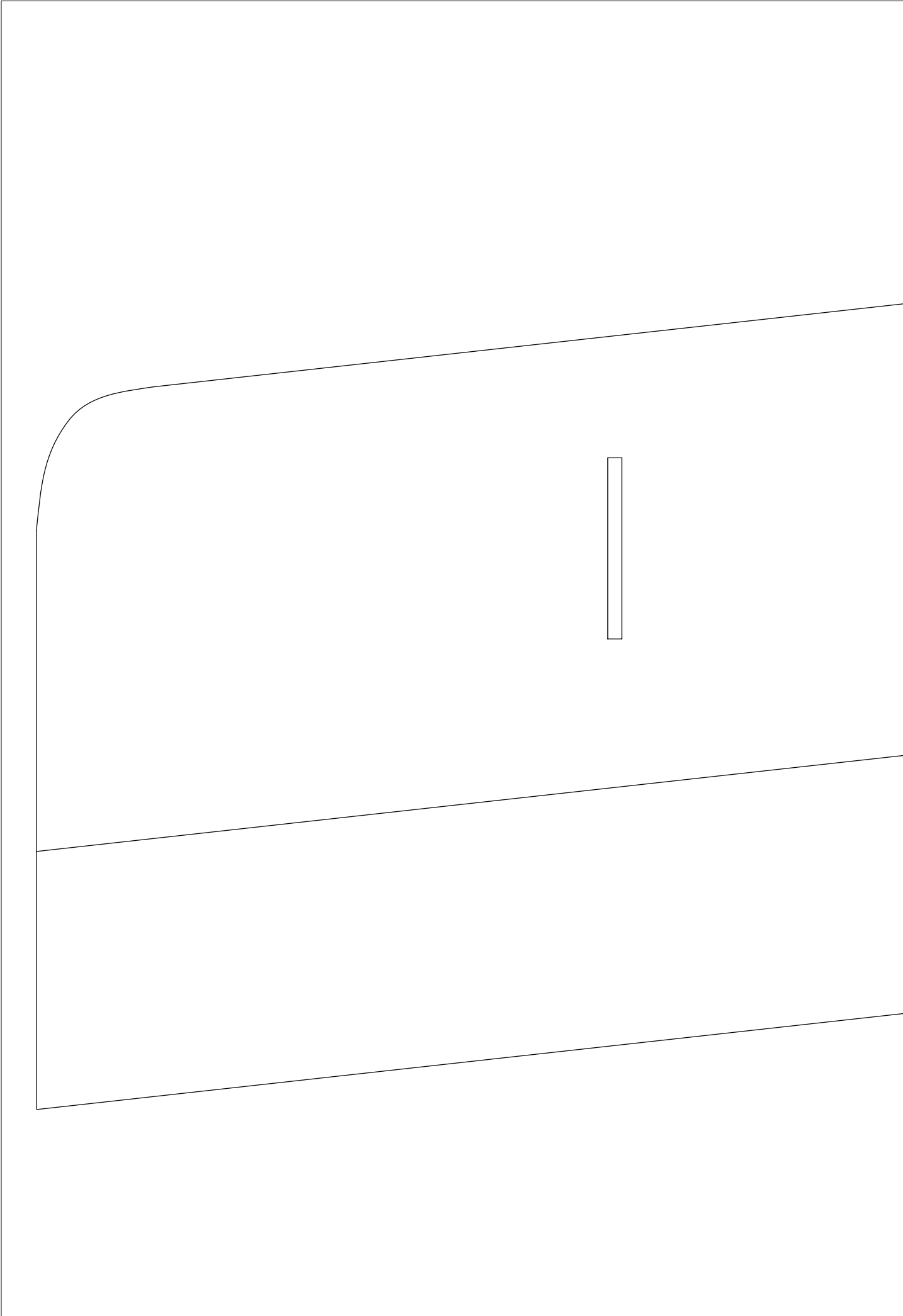

Both wings cut from a single piece of 3mm Depron

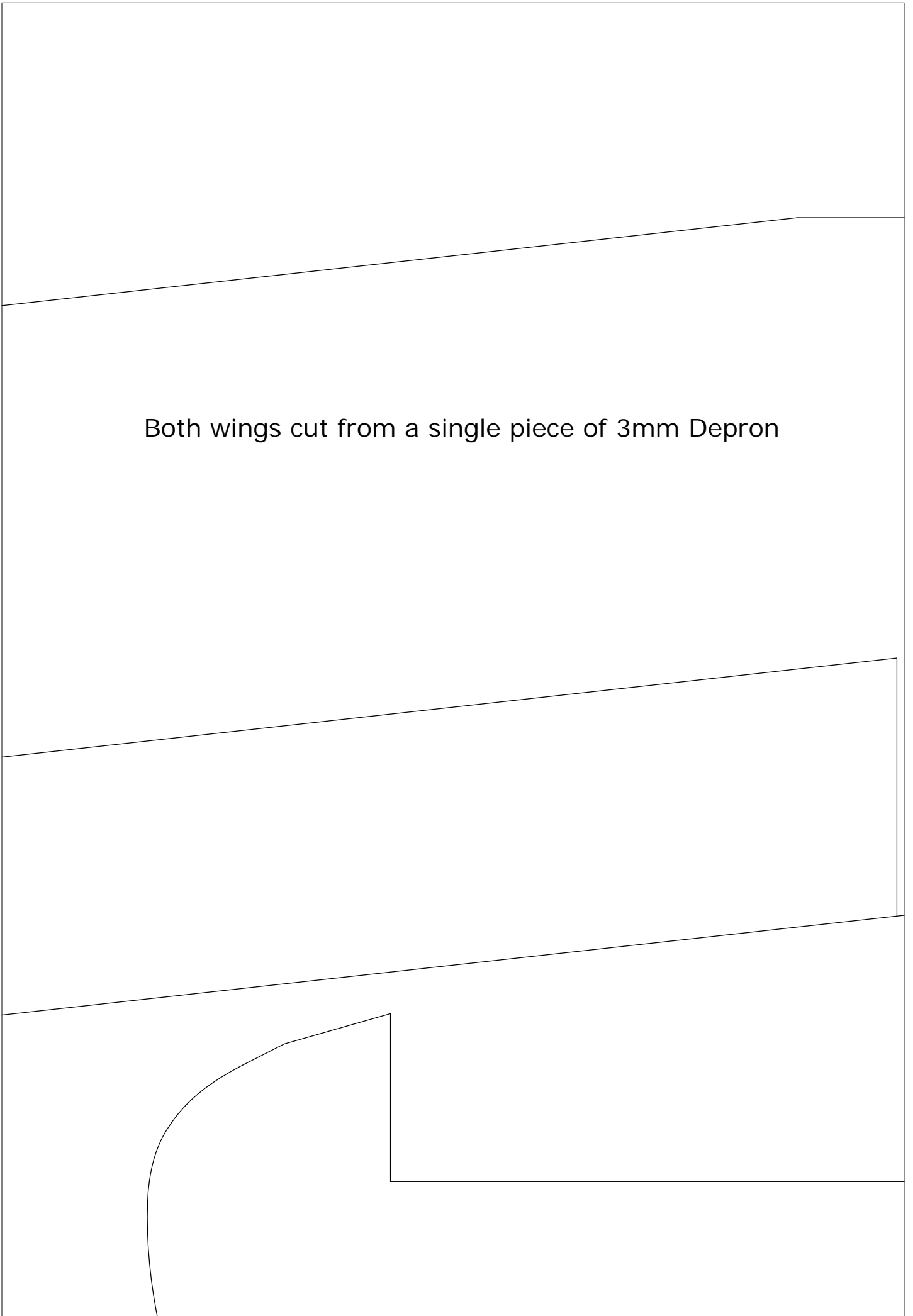

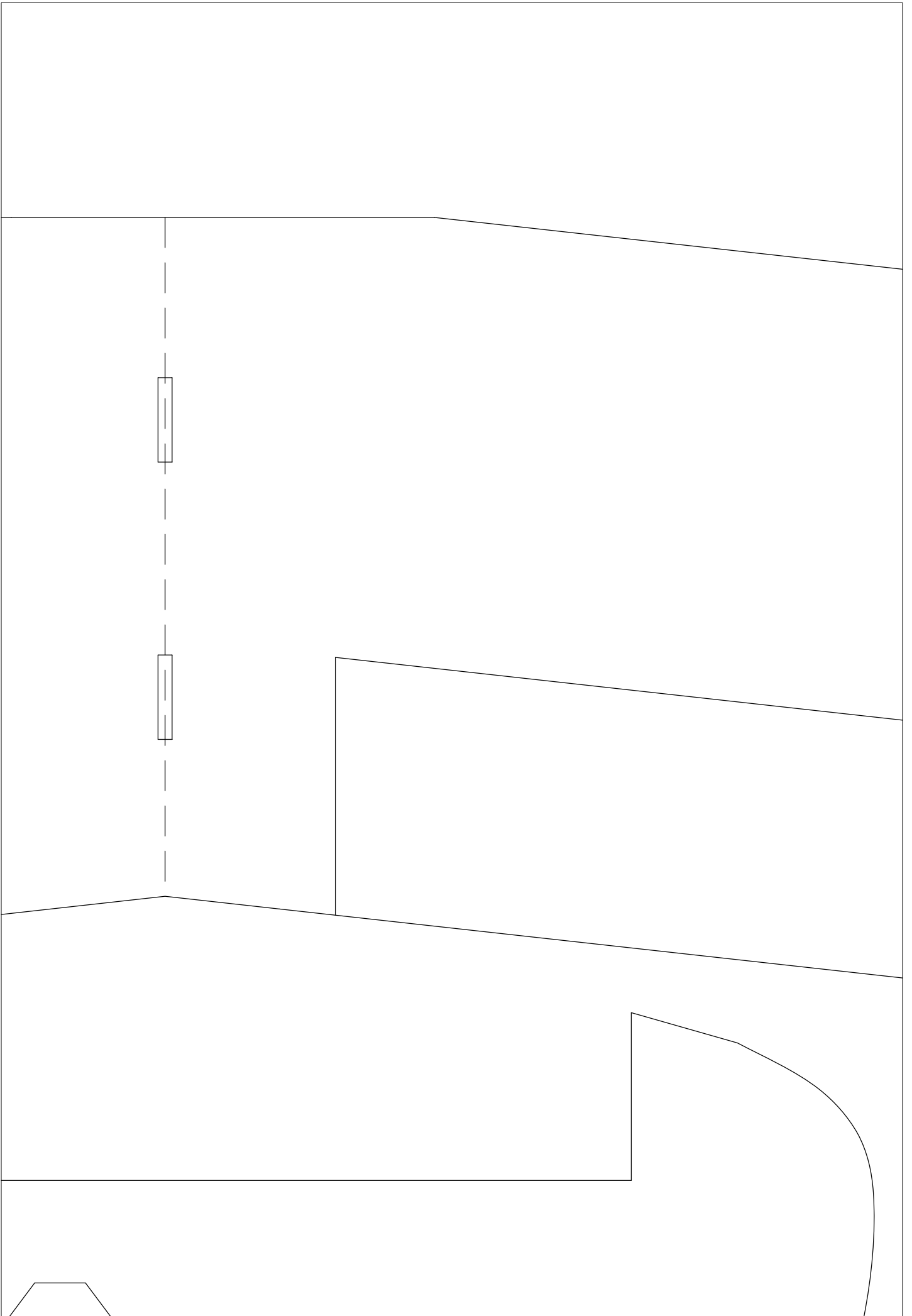

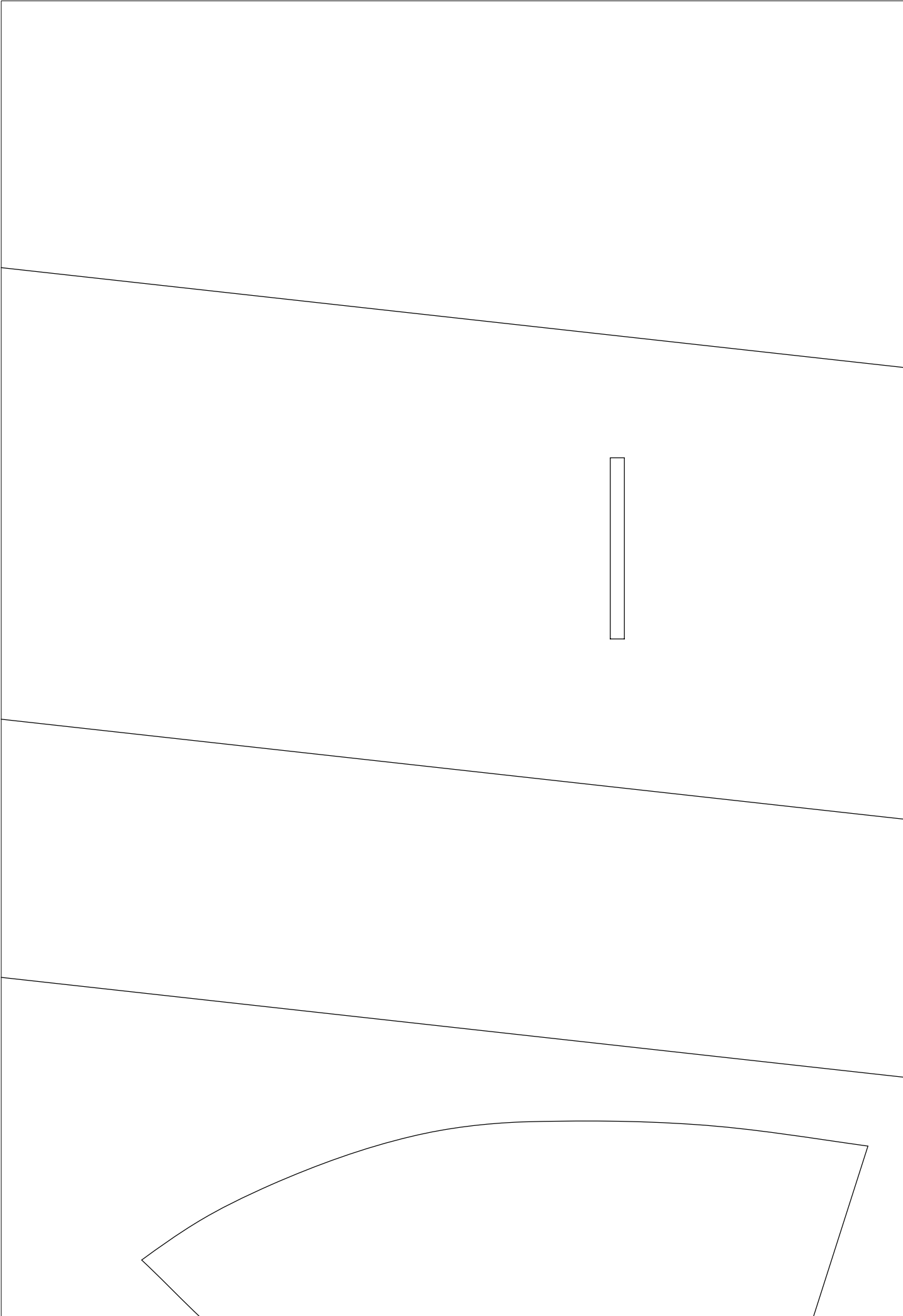

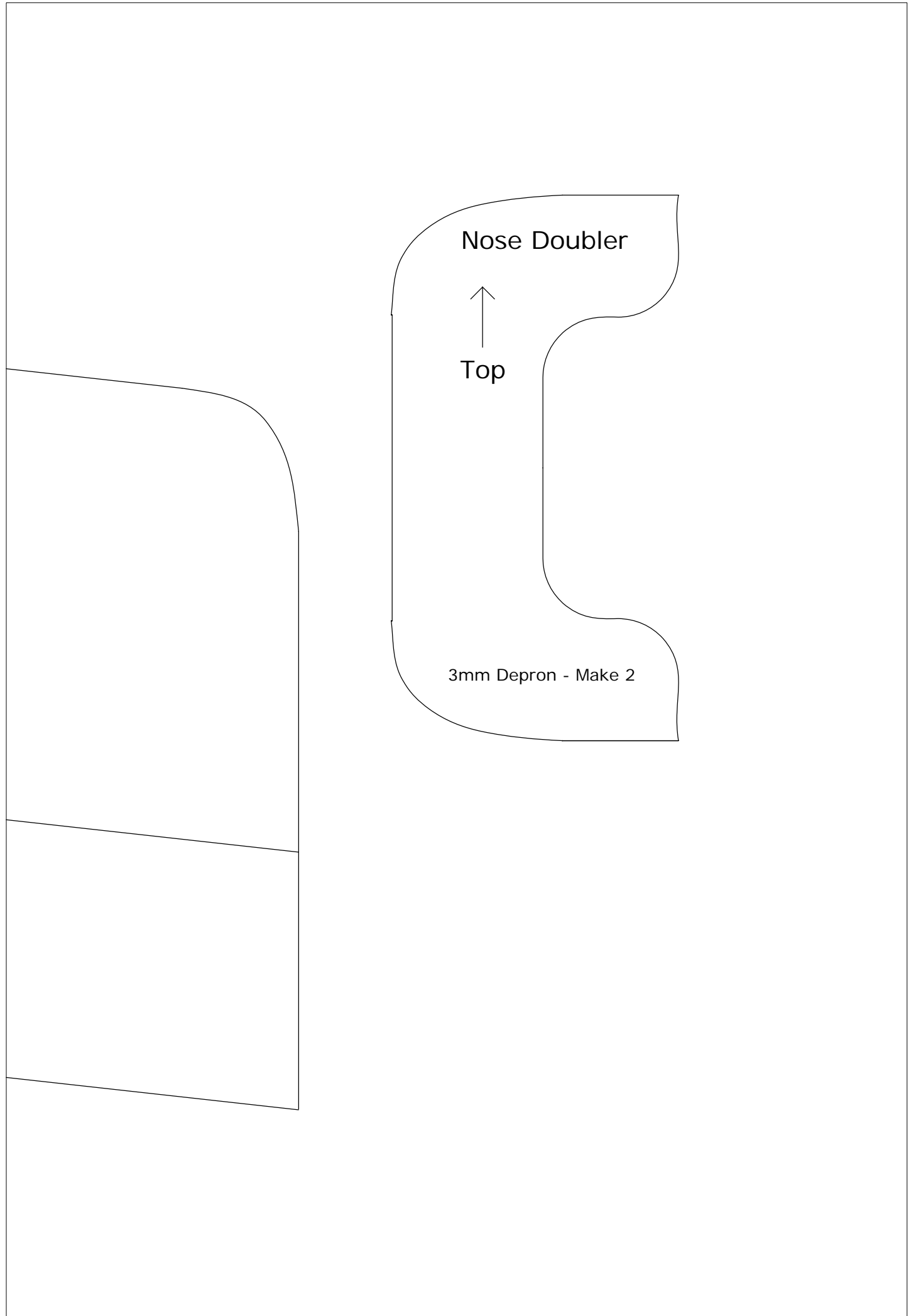

Nose Doubler



Top

3mm Depron - Make 2