

Monoblock J3 Cub
(KFM3 Style Wing)
By: BlueFFF

WING SPAN: 44"
WING AREA: 413.5 SQ. IN.
FUSE LENGTH: 29.5"

These plans are intended for personal use and commercial sale is prohibited.

Note: Removable wing braces made from bamboo skewers may be added if desired, but are not required for flight.

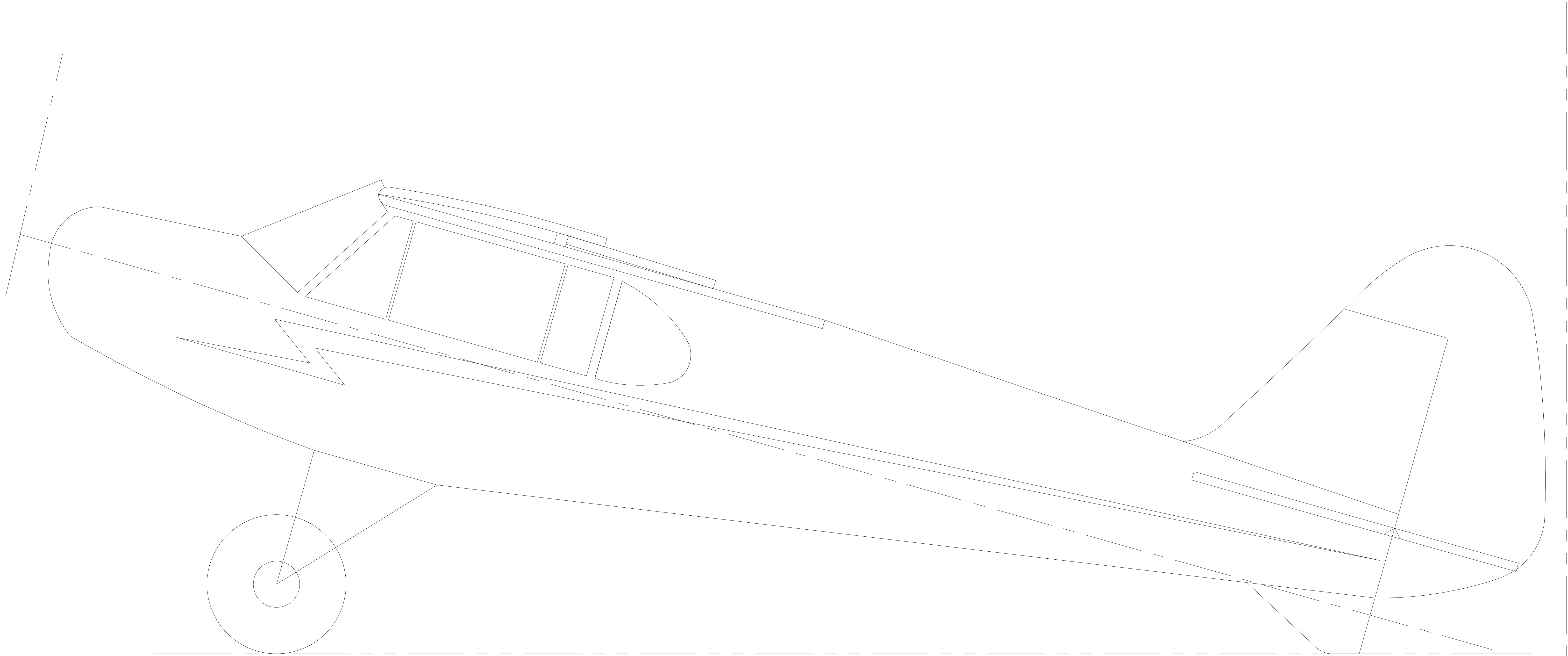

Monoblock J3 Cub

(KFM3 Style Wing)

By: BlueFFF

WING SPAN: 44"

WING AREA: 413.5 SQ. IN.

FUSE LENGTH: 29.5"

These plans are intended for personal use and commercial sale is prohibited.

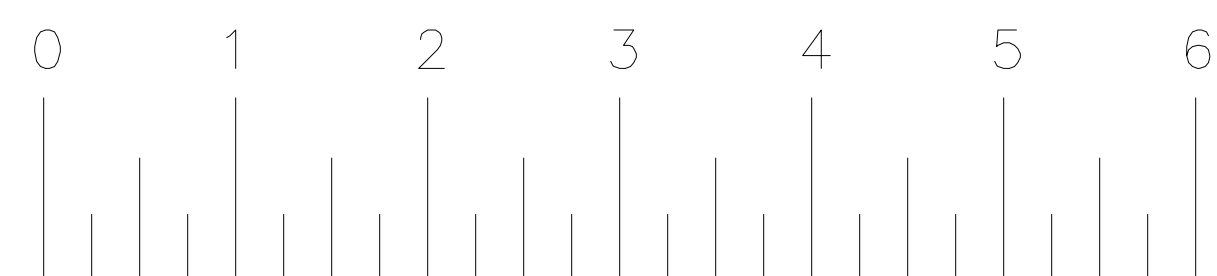

Note: Removable wing braces made from bamboo skewers may be added if desired, but are not required for flight.

Joiner 2" Dihedral

Joiner 1" Dihedral

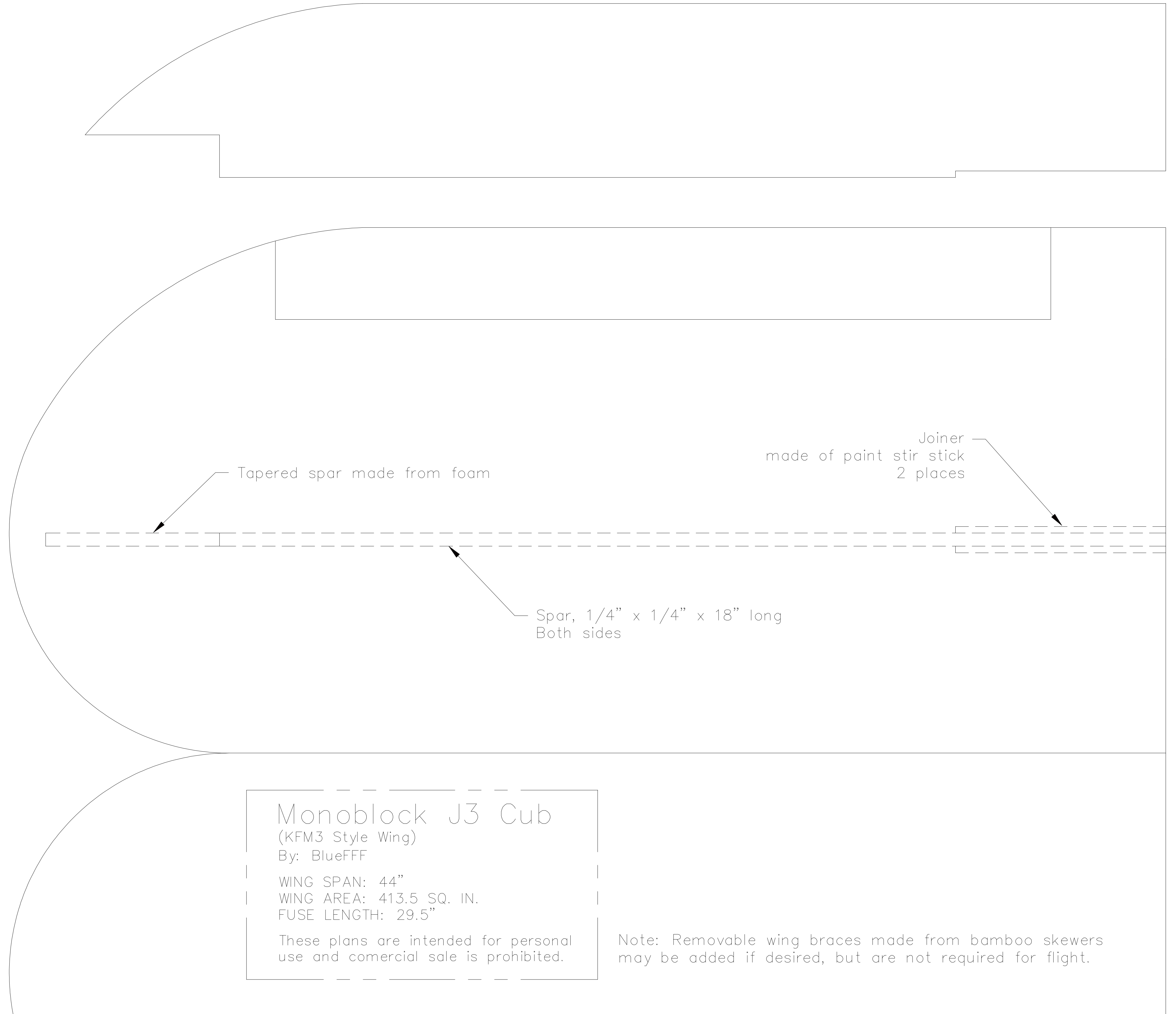
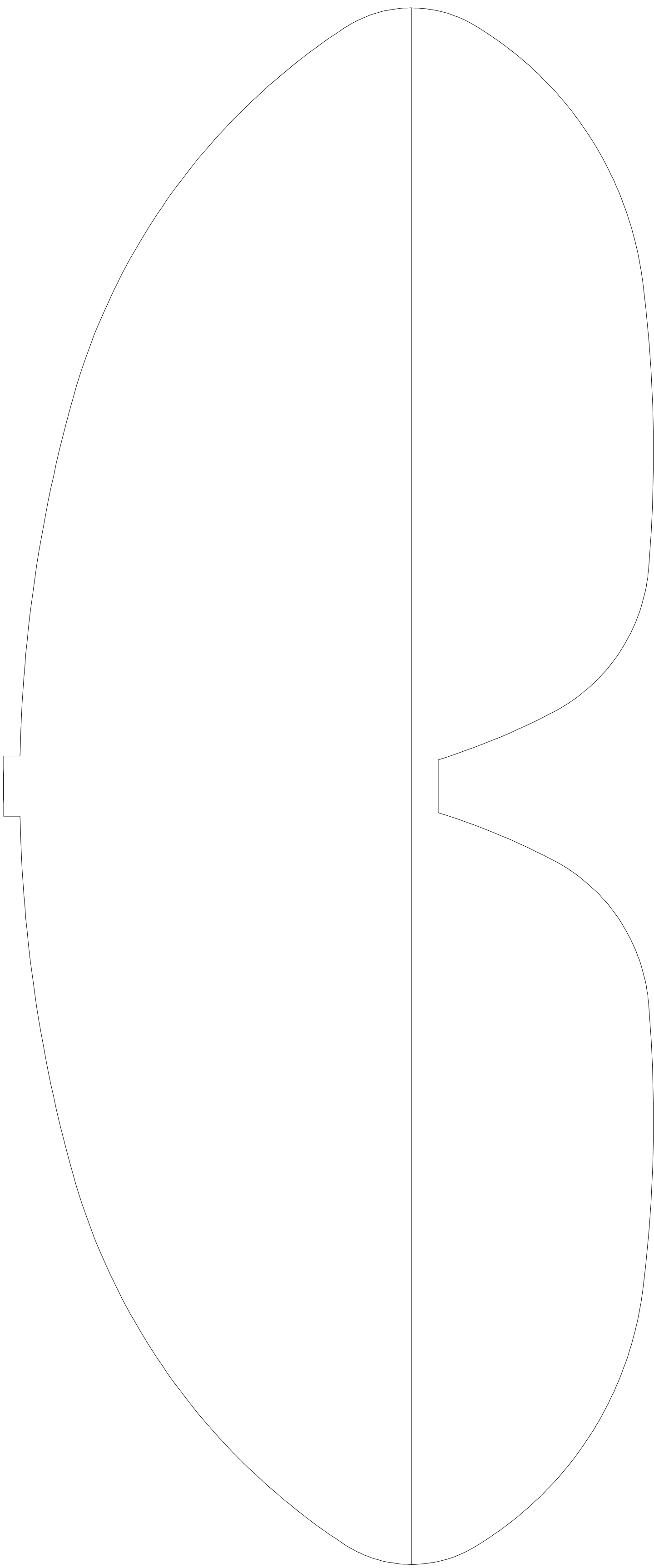

Monoblock J3 Cub

(KFM3 Style Wing)

By: BlueFFF

WING SPAN: 44"

WING AREA: 413.5 SQ. IN.

FUSE LENGTH: 29.5"

These plans are intended for personal use and commercial sale is prohibited.

Note: Removable wing braces made from bamboo skewers may be added if desired, but are not required for flight.

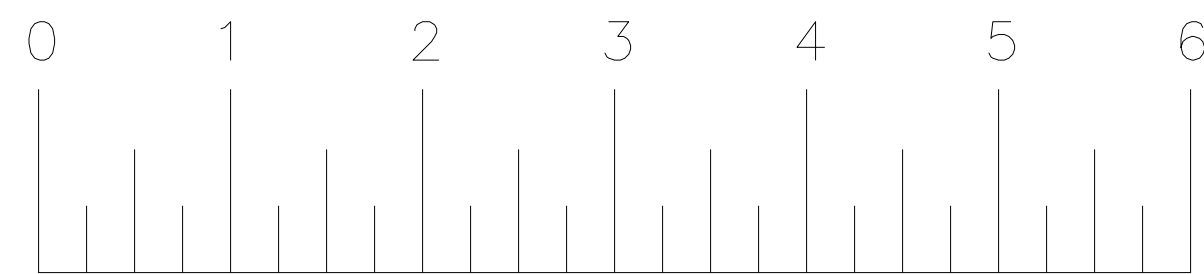

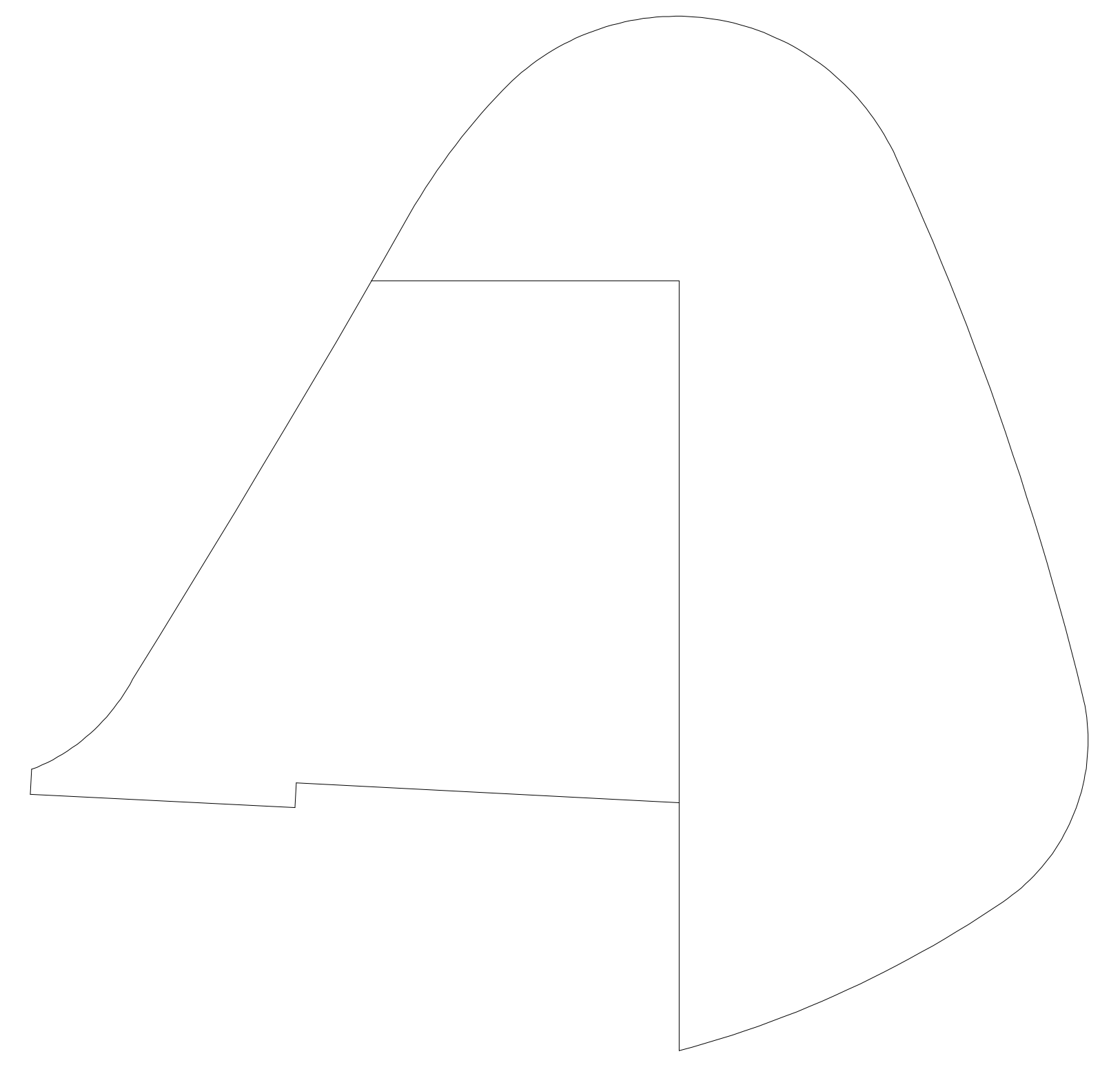
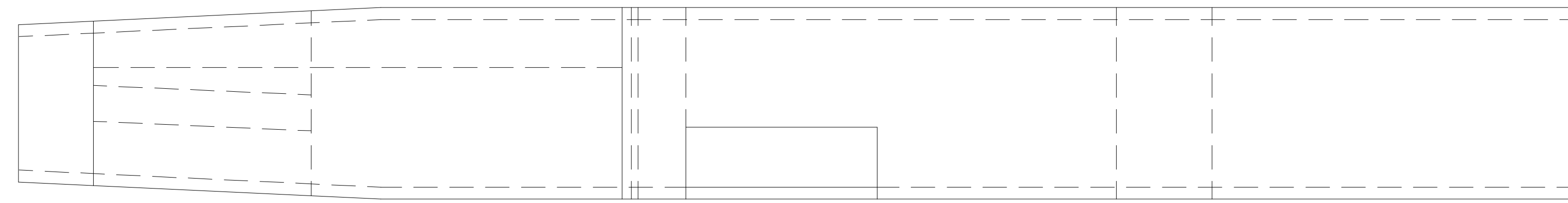
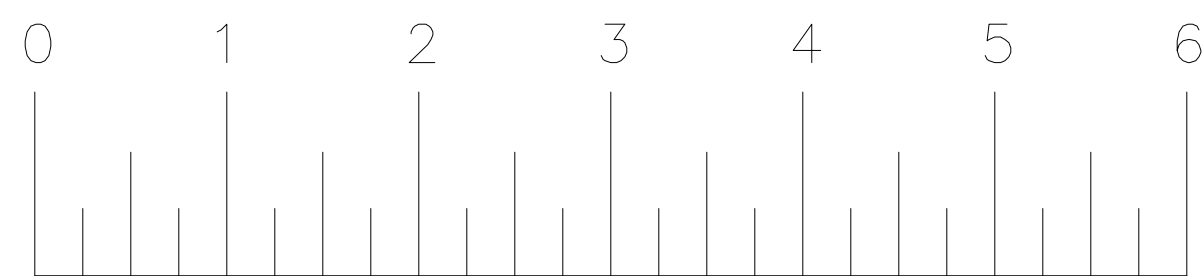
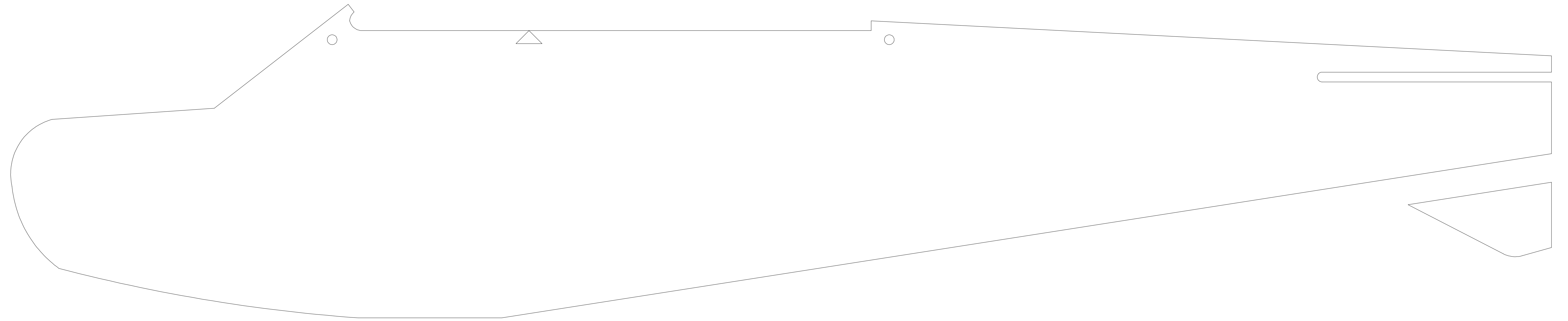

Monoblock J3 Cub
(KFM3 Style Wing)
By: BlueFFF
WING SPAN: 44"
WING AREA: 413.5 SQ. IN.
FUSE LENGTH: 29.5"
These plans are intended for personal use and commercial sale is prohibited.

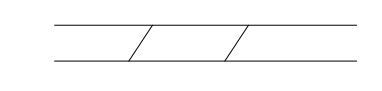
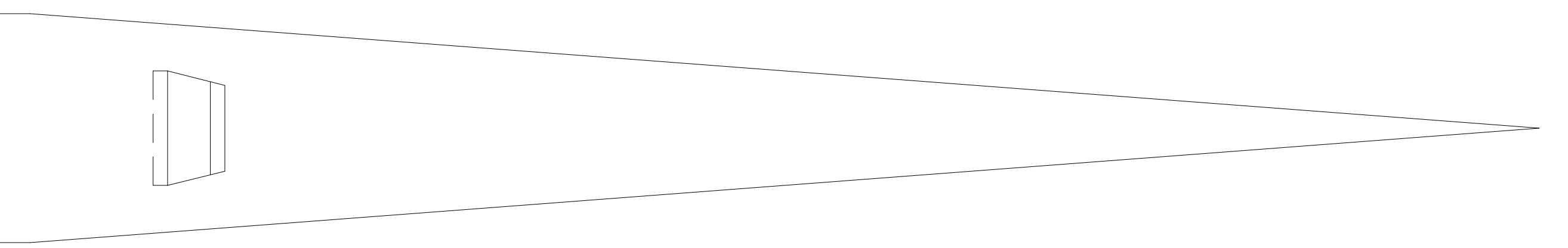
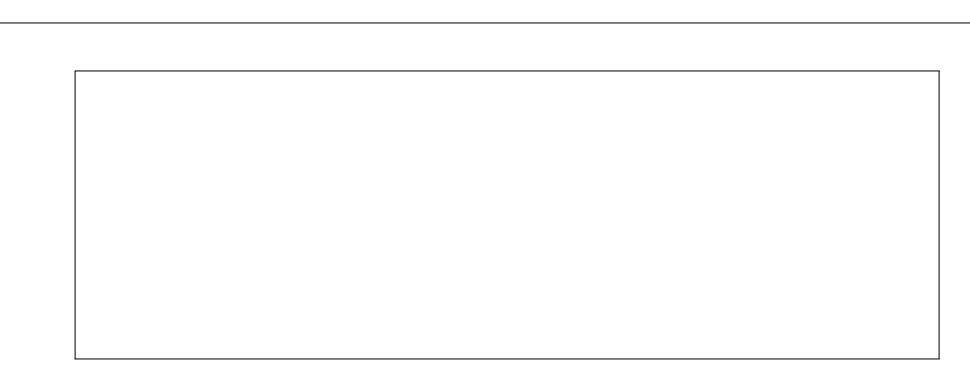
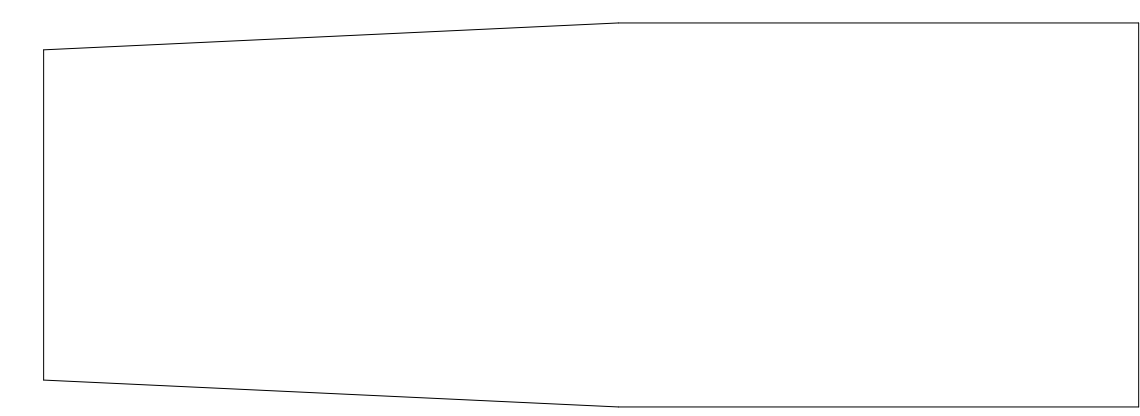
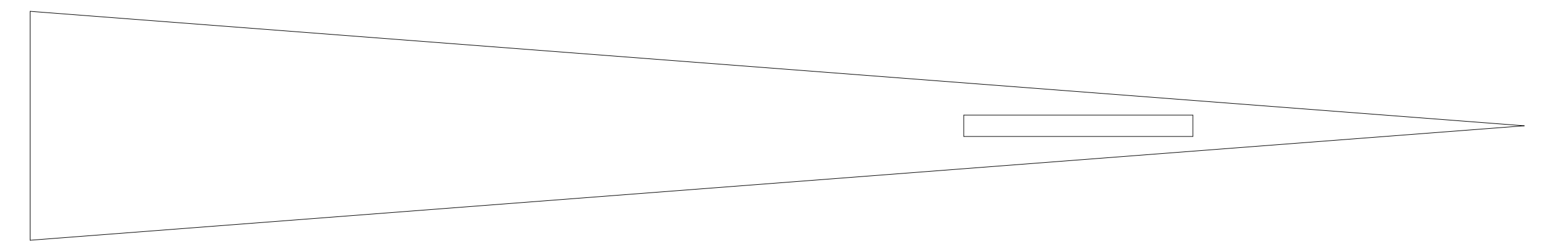
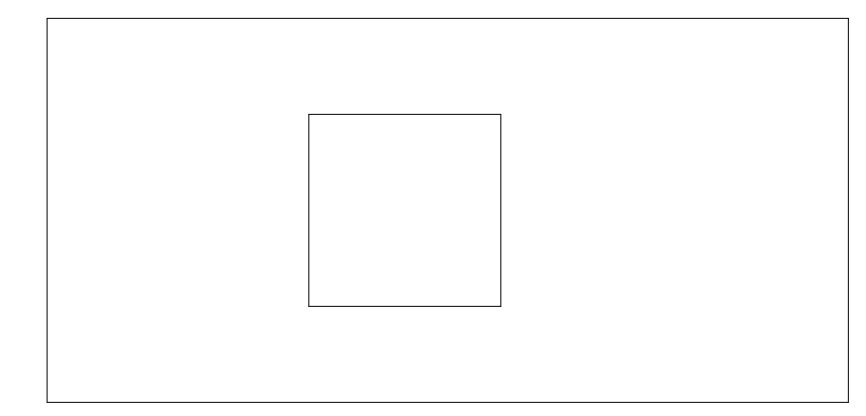
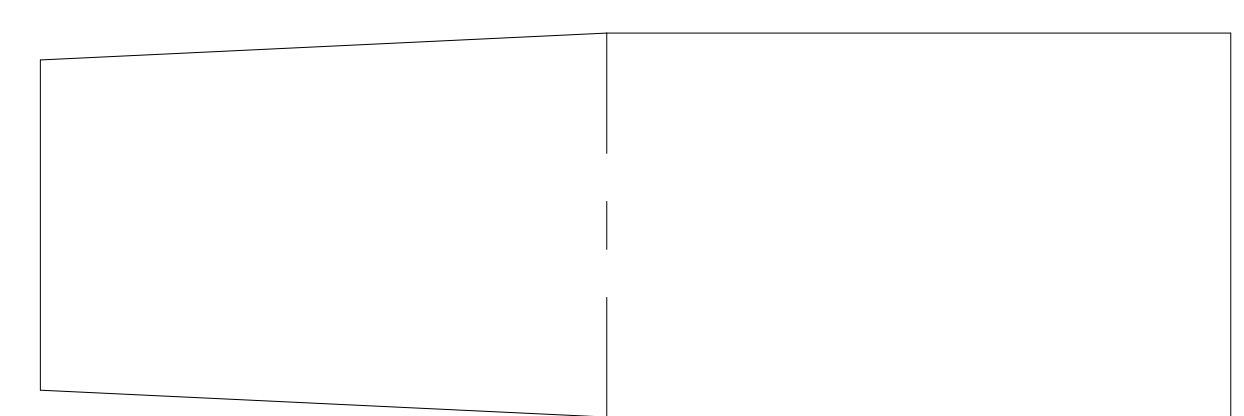
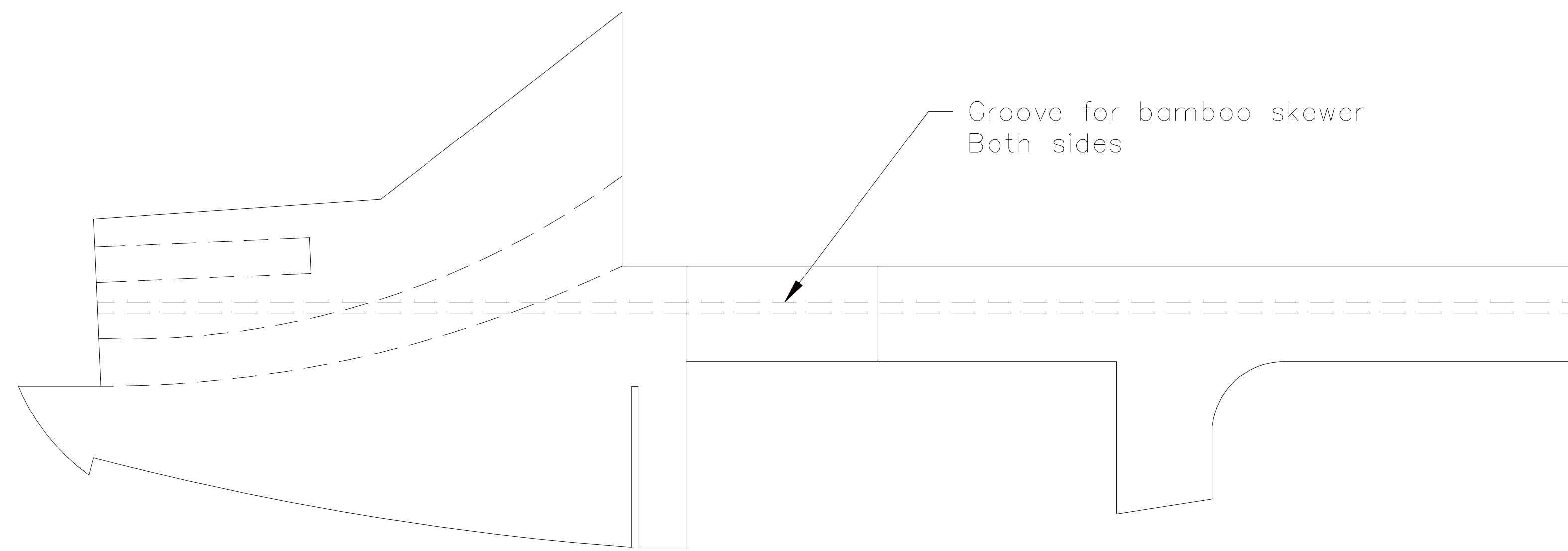

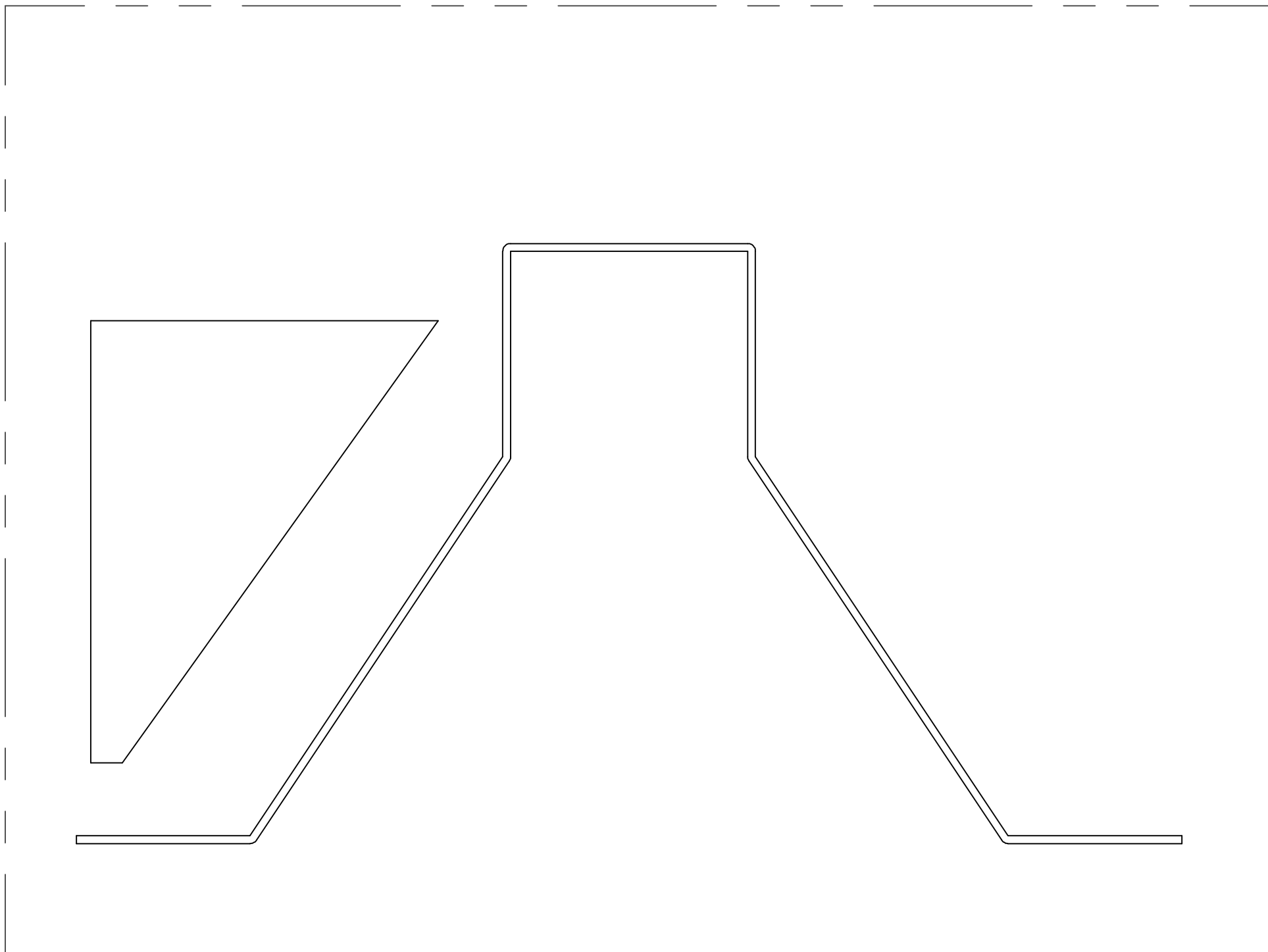

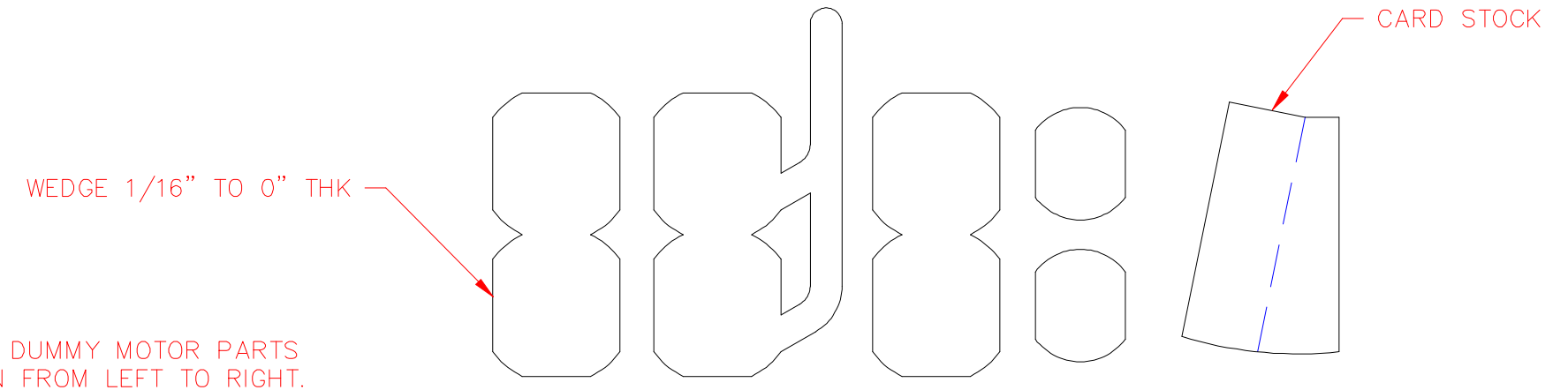
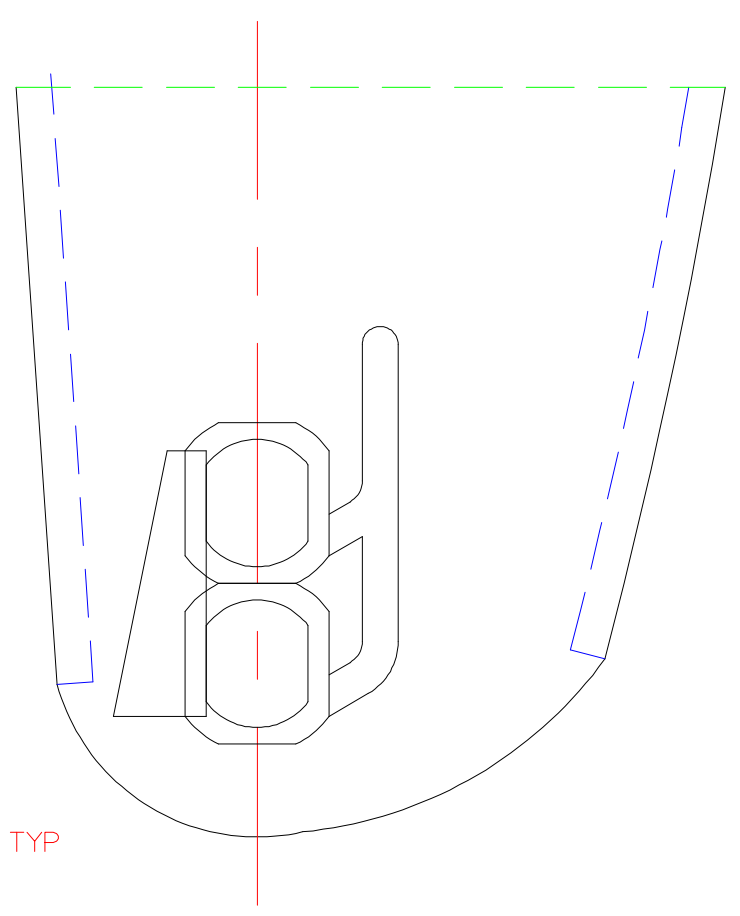
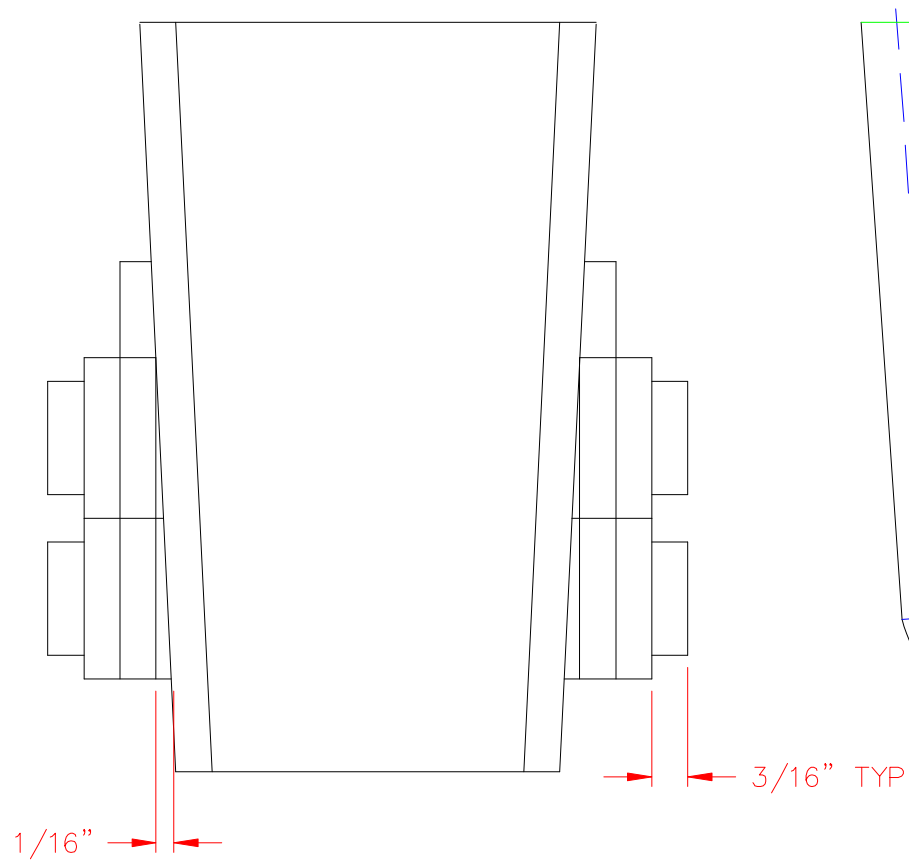

NOTE: DUMMY MOTOR PARTS SHOWN FROM LEFT TO RIGHT.

