

1/2" DIHEDRAL UNDER EACH WING TIP

SLOT WING SHEETING FOR ENGINE PYLON

1/4" X 3/8" SHAPED BALSA L. E.

1/4" BALSA GUSSETS (4 CORNERS)

1/8" X 1/4" SPRUCE SPARS

DIHEDRAL BRACES

1/16" SHEET CENTER SECTION

SHAPED BALSA BLOCK TIPS

1/4" X 3/4" SHAPED BALSA T. E.

1/8" BALSA DIHEDRAL BRACES

L. E.

T. E.

MAIN

WING RIB - 1/16" BALSA - MAKE 26

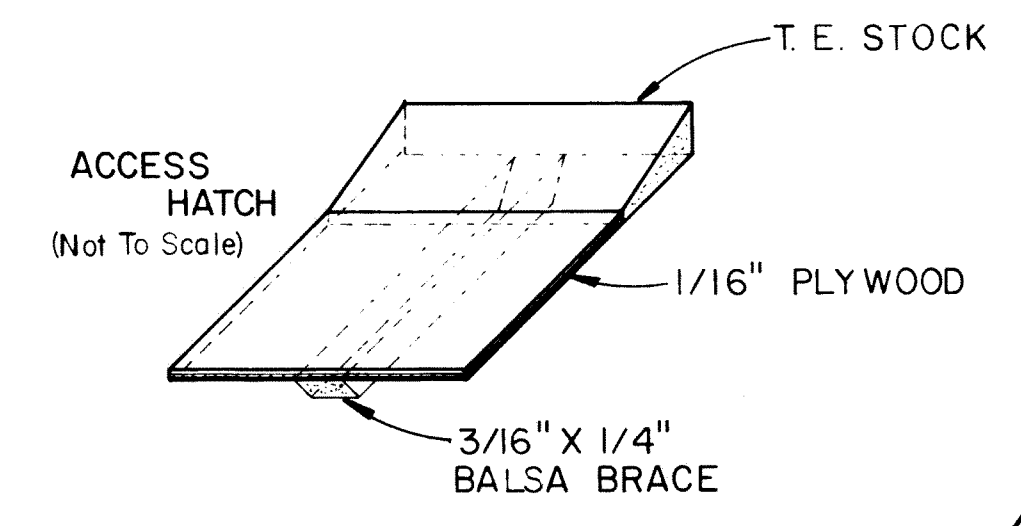
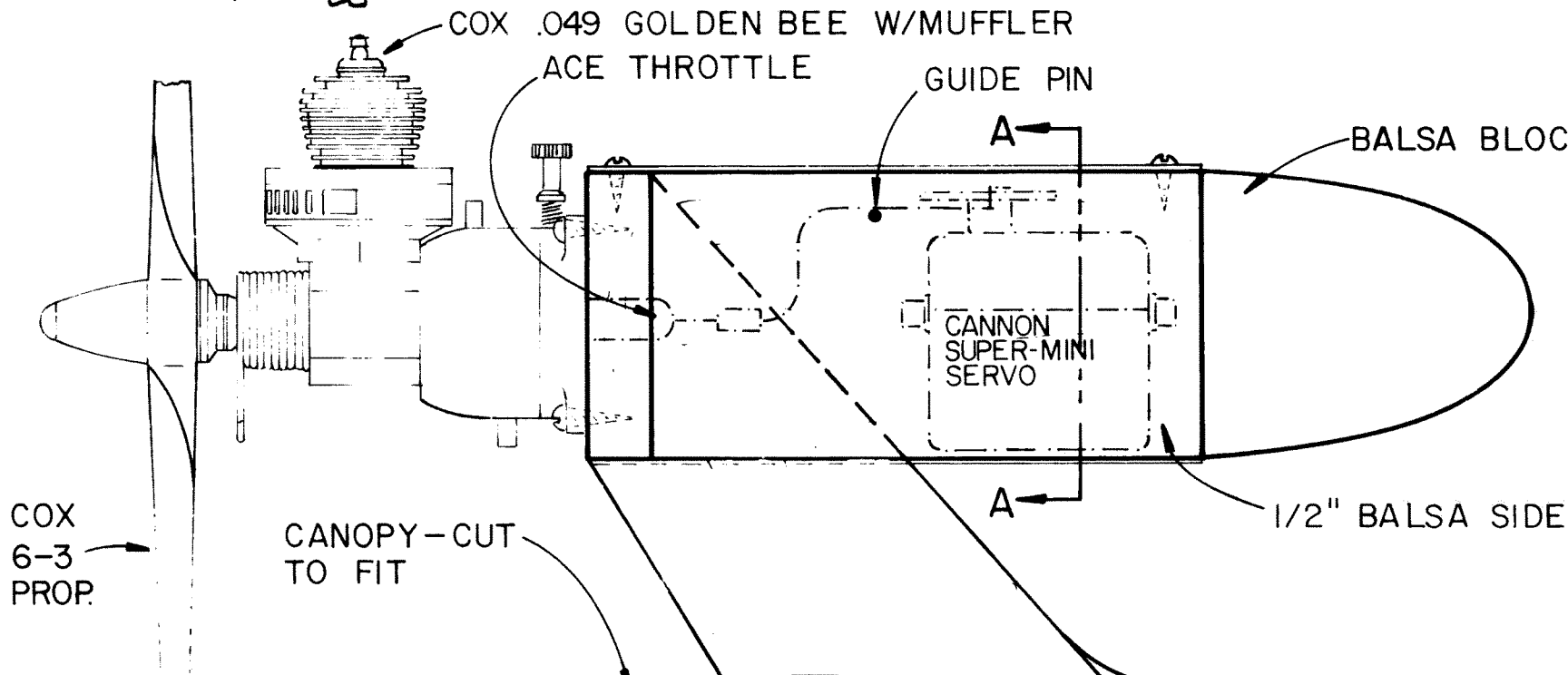
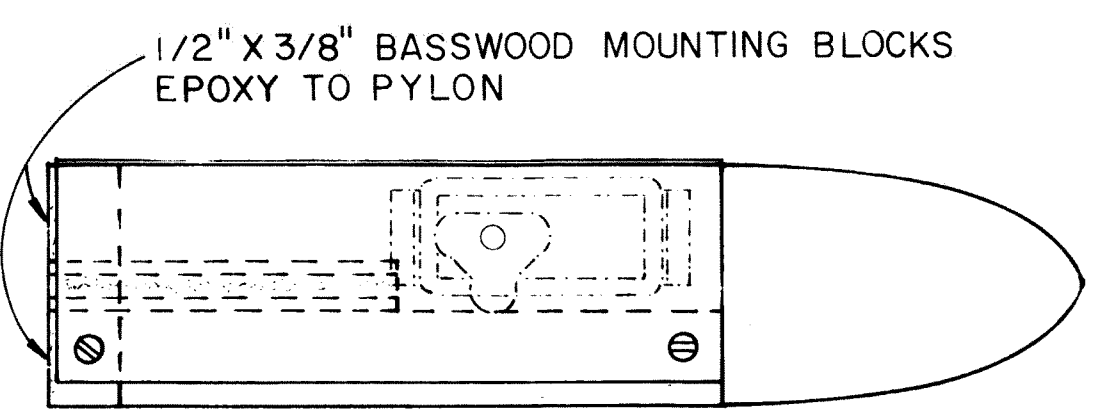
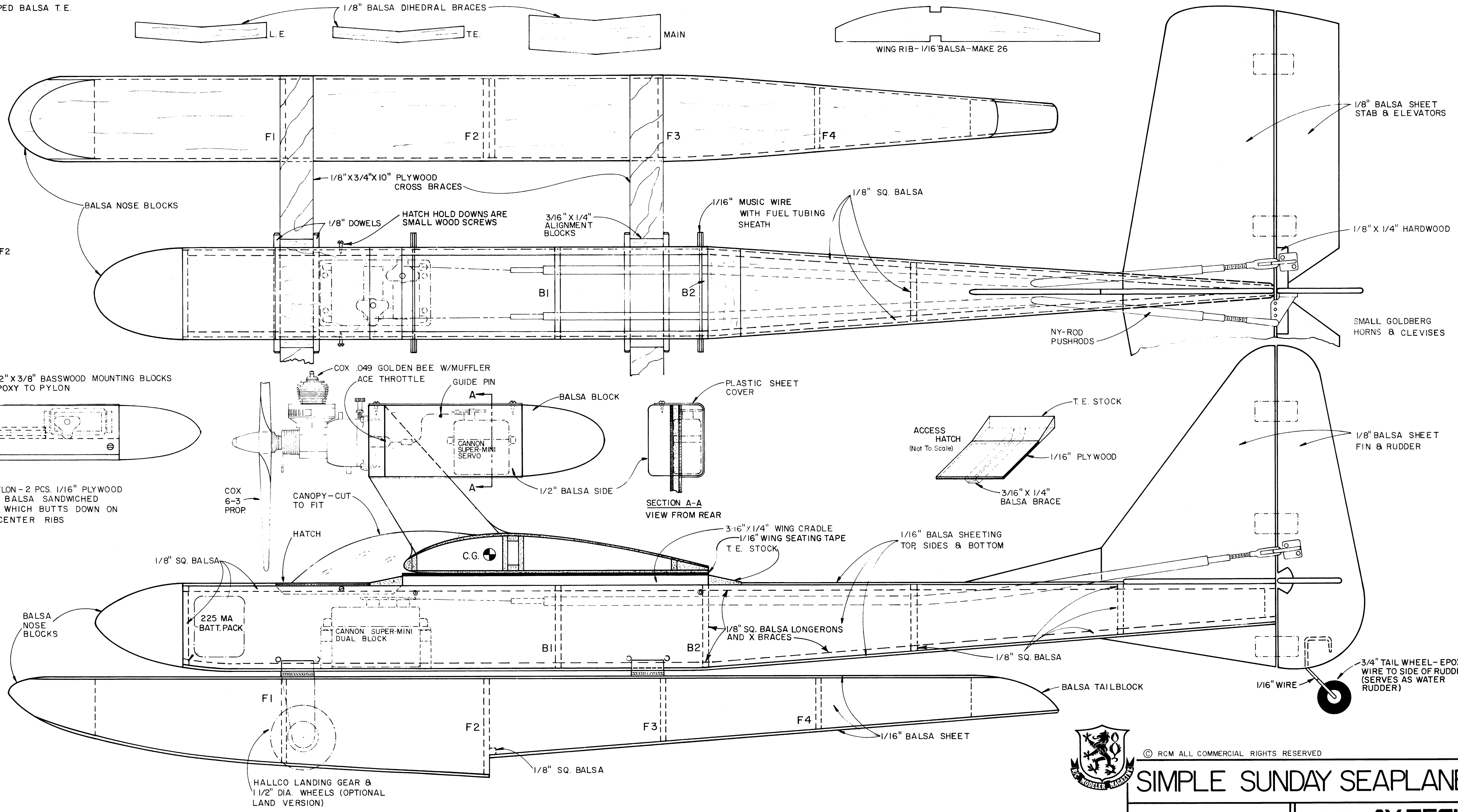
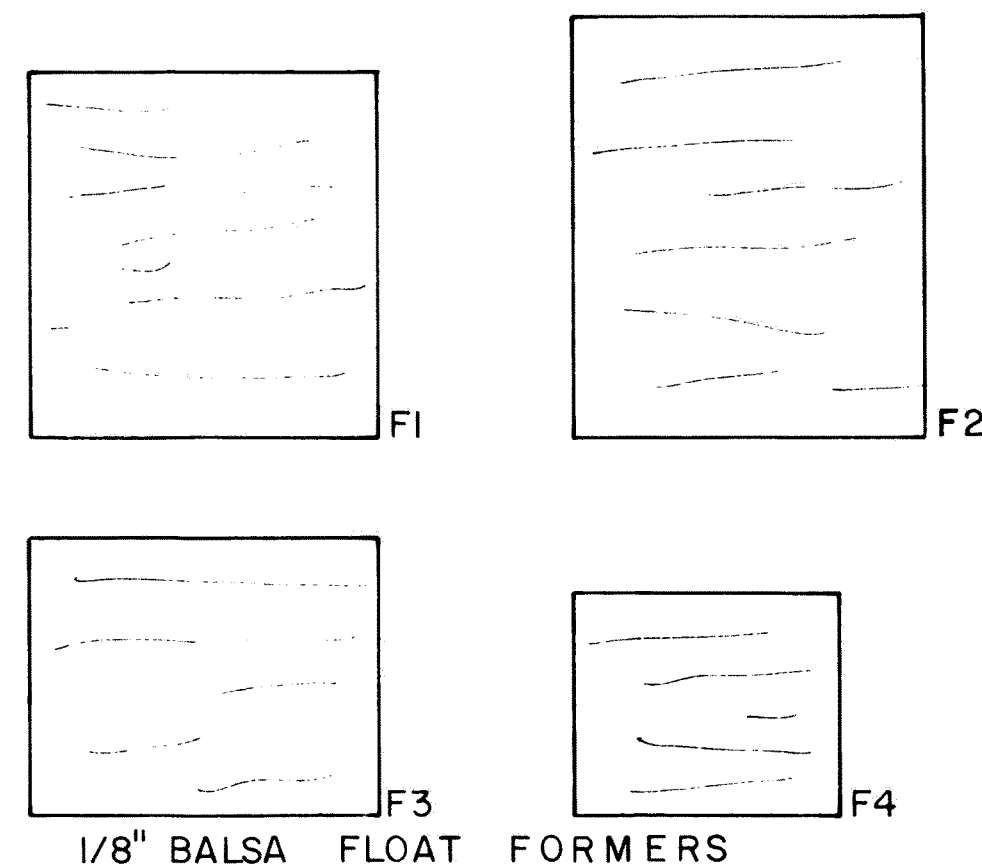
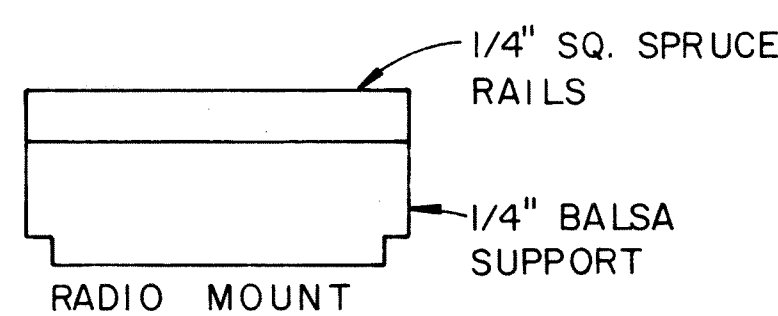

ENGINE PYLON - 2 PCS. 1/16" PLYWOOD WITH 1/8" BALSA SANDWICHED BETWEEN WHICH BUTTS DOWN ON TOP OF CENTER RIBS

CANOPY - CUT TO FIT
HATCH

SECTION A-A VIEW FROM REAR

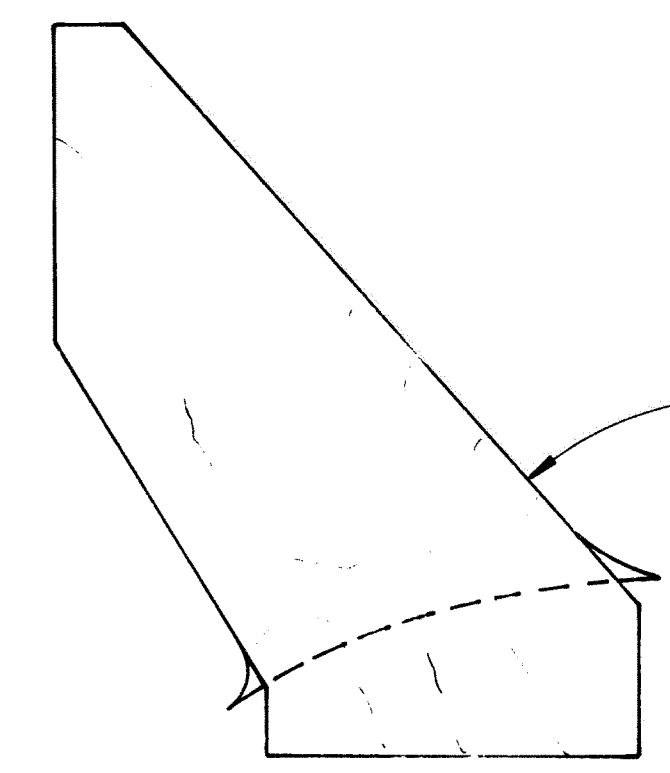

Balsa nose blocks

225 MA BATT. PACK

CANNON SUPER-MINI DUAL BLOCK

C.G.

3/16" X 1/4" WING CRADLE
1/16" WING SEATING TAPE
T. E. STOCK

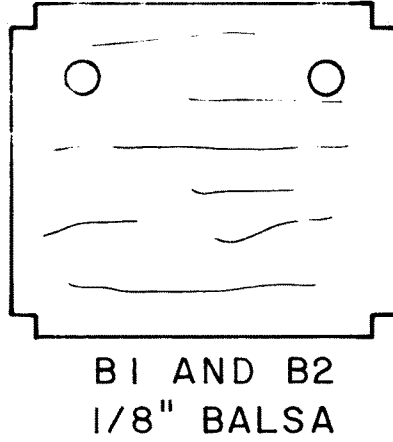

HALLCO LANDING GEAR & 1/2" DIA. WHEELS (OPTIONAL LAND VERSION)

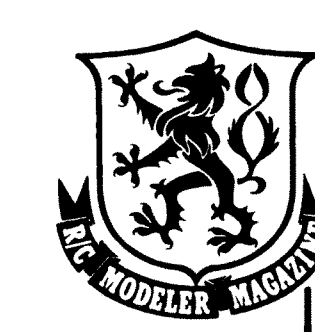

© RCM ALL COMMERCIAL RIGHTS RESERVED

SIMPLE SUNDAY SEAPLANE

DESIGNED BY KEN WILLARD

PLANS BY AV-TECH

