

MILLER AIRCRAFT CO.
 GEE BEE "Zeta"
 SCALE 2.4 IN = 1 FT (1/5 TH)
 DESIGNED & DRAWN BY HENRY A. HAFFKE
 PLATE 1 OF 2

MILLER AIRCRAFT CO.



GEE BEE "Zeta"

SCALE 2.4 IN. = 1 FT
DESIGNED & DRAWN
BY
HENRY A. HAFFKE
PLATE 2 OF 2
PARTS PATTERNS

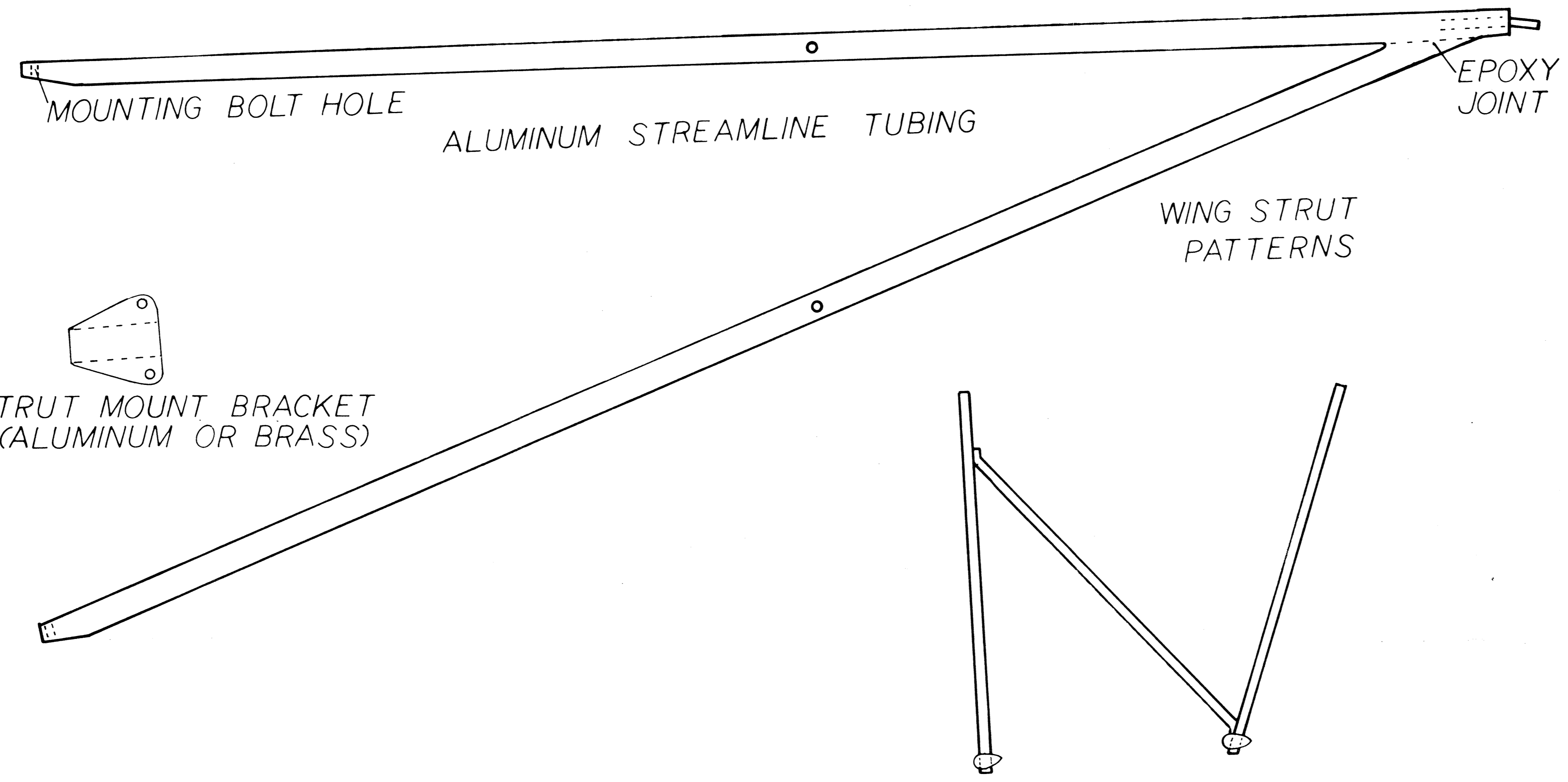
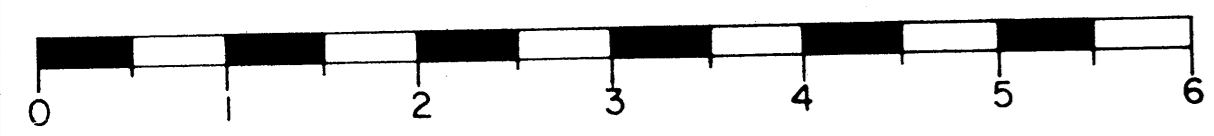

STRUT MOUNT BRACKET
(ALUMINUM OR BRASS)

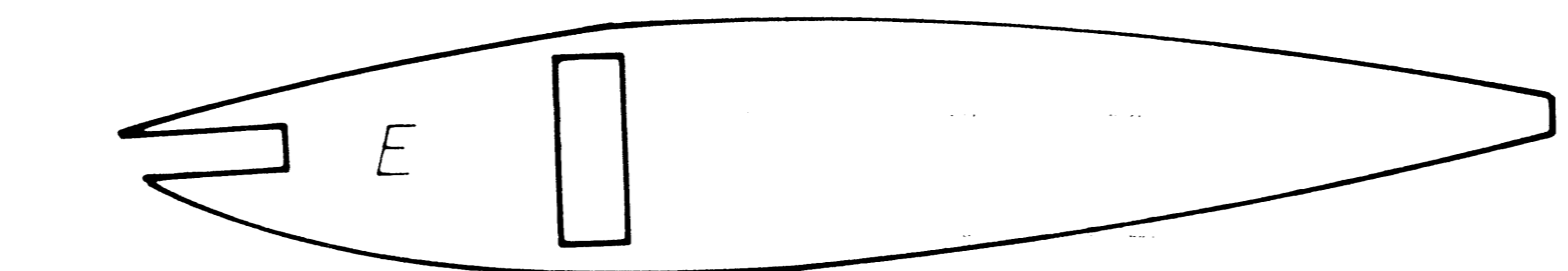
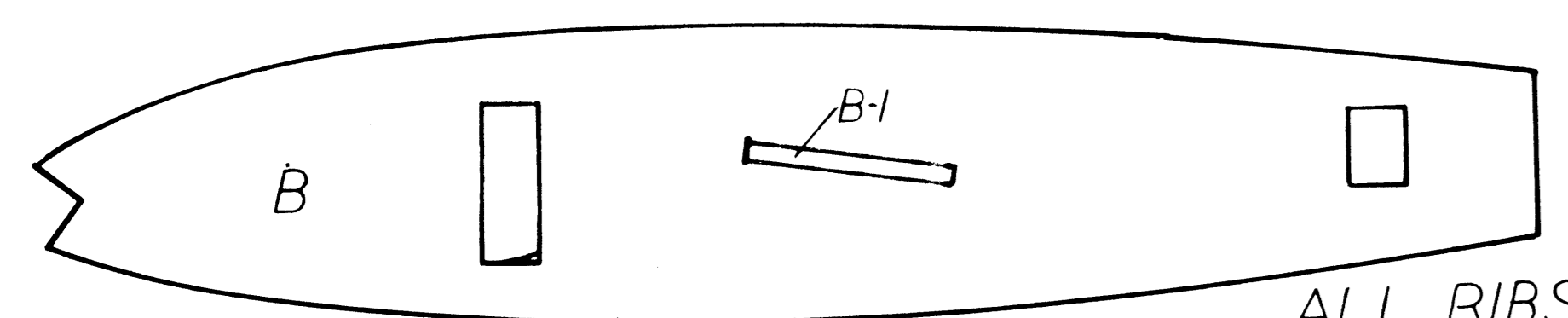
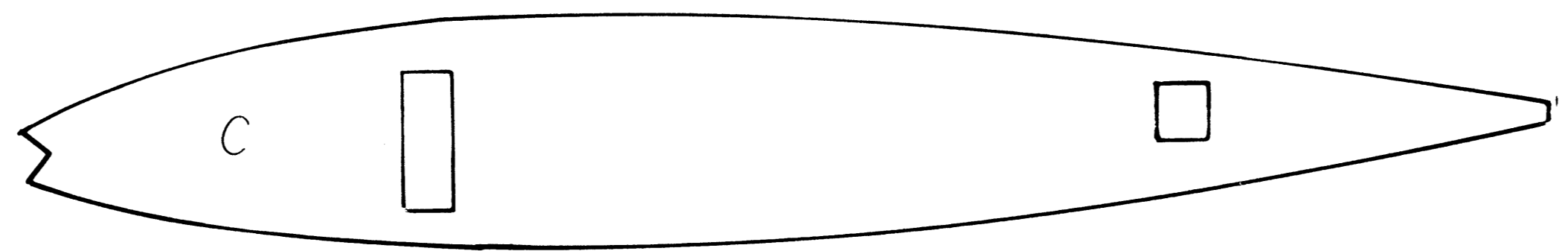
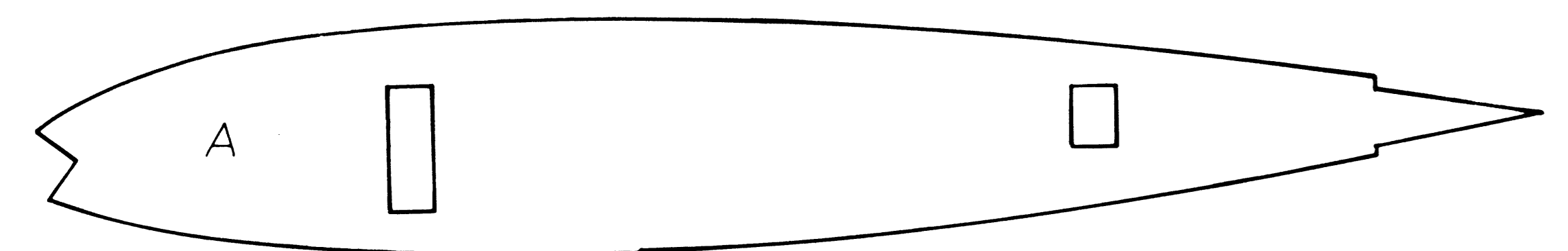
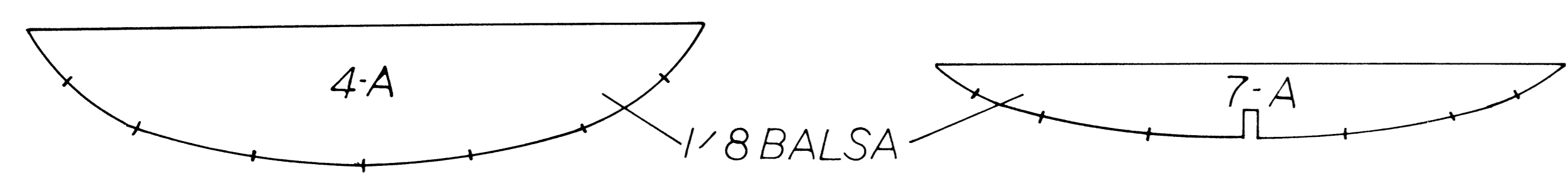
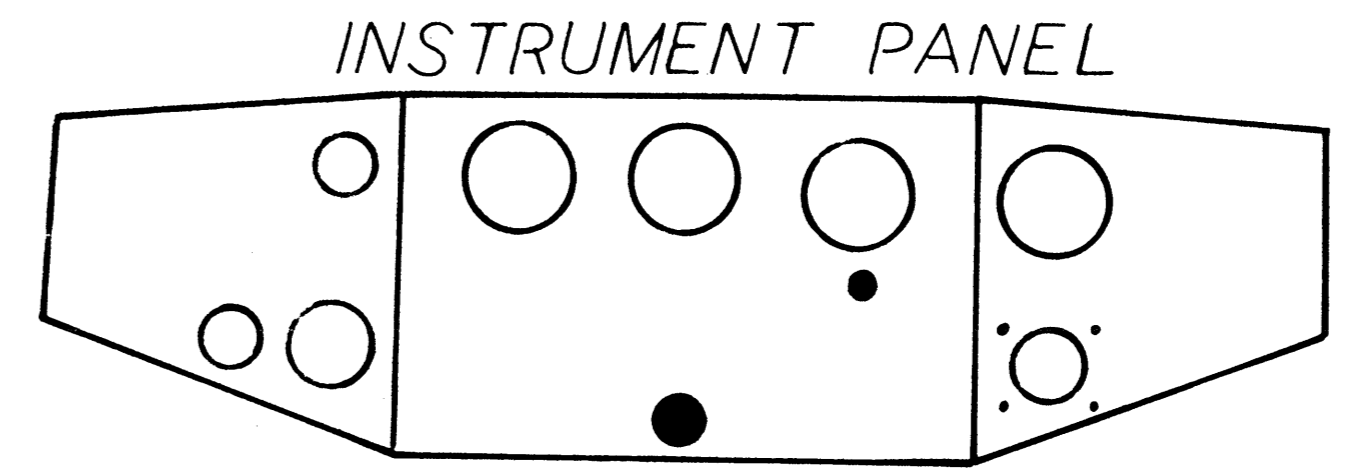
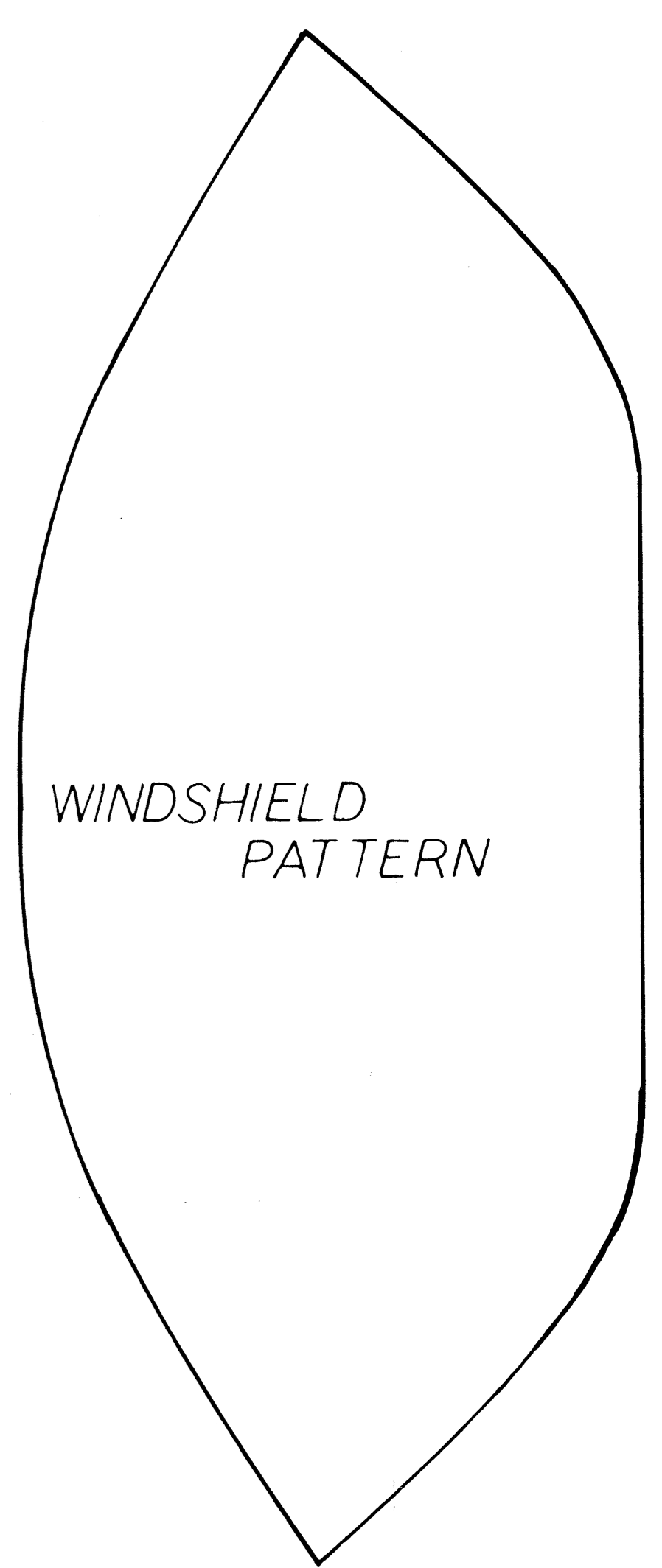
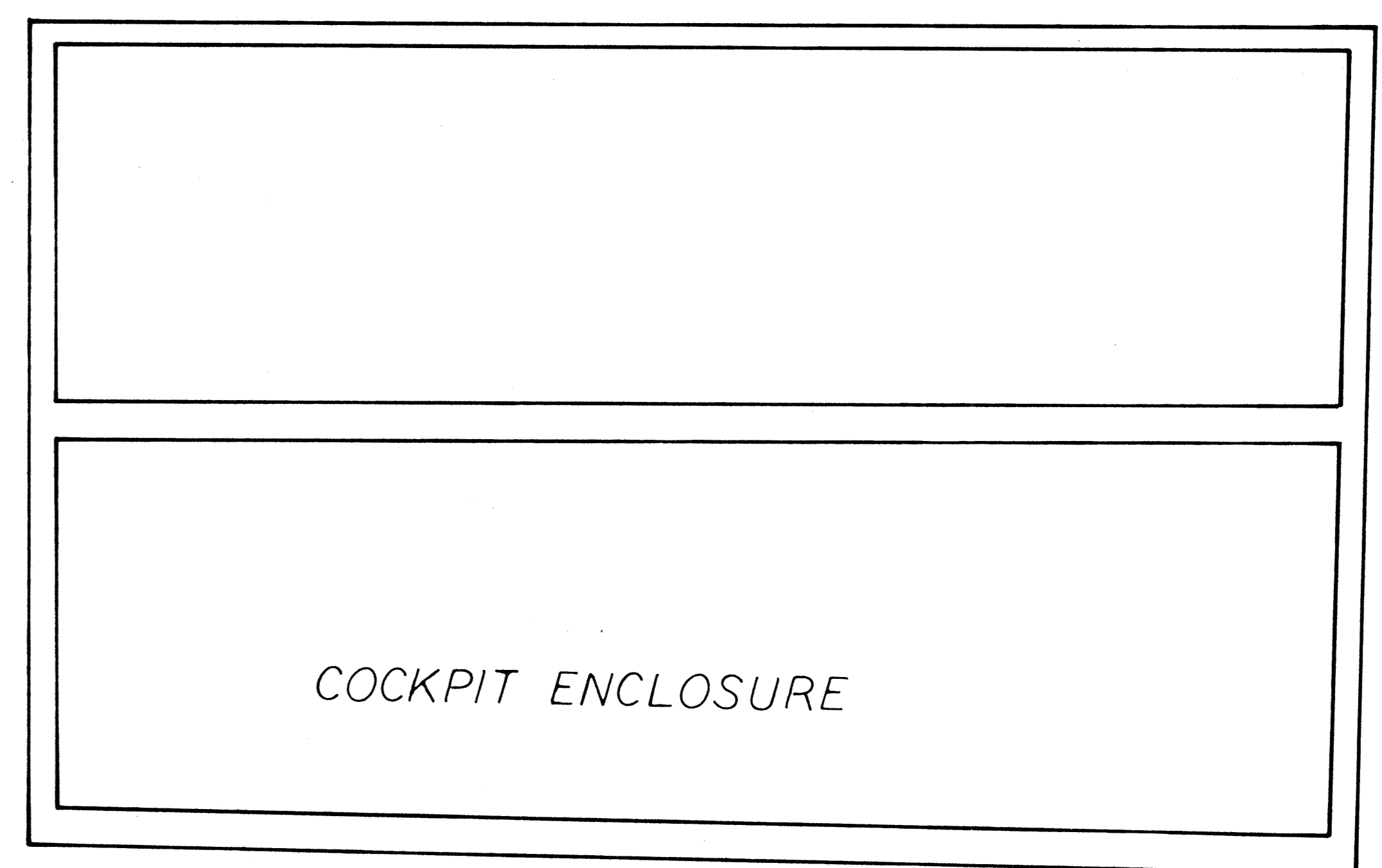

ALL RIBS OF 3/32 Balsa EXCEPT AS NOTED

DIHEDRAL BRACES 1/8 PLY

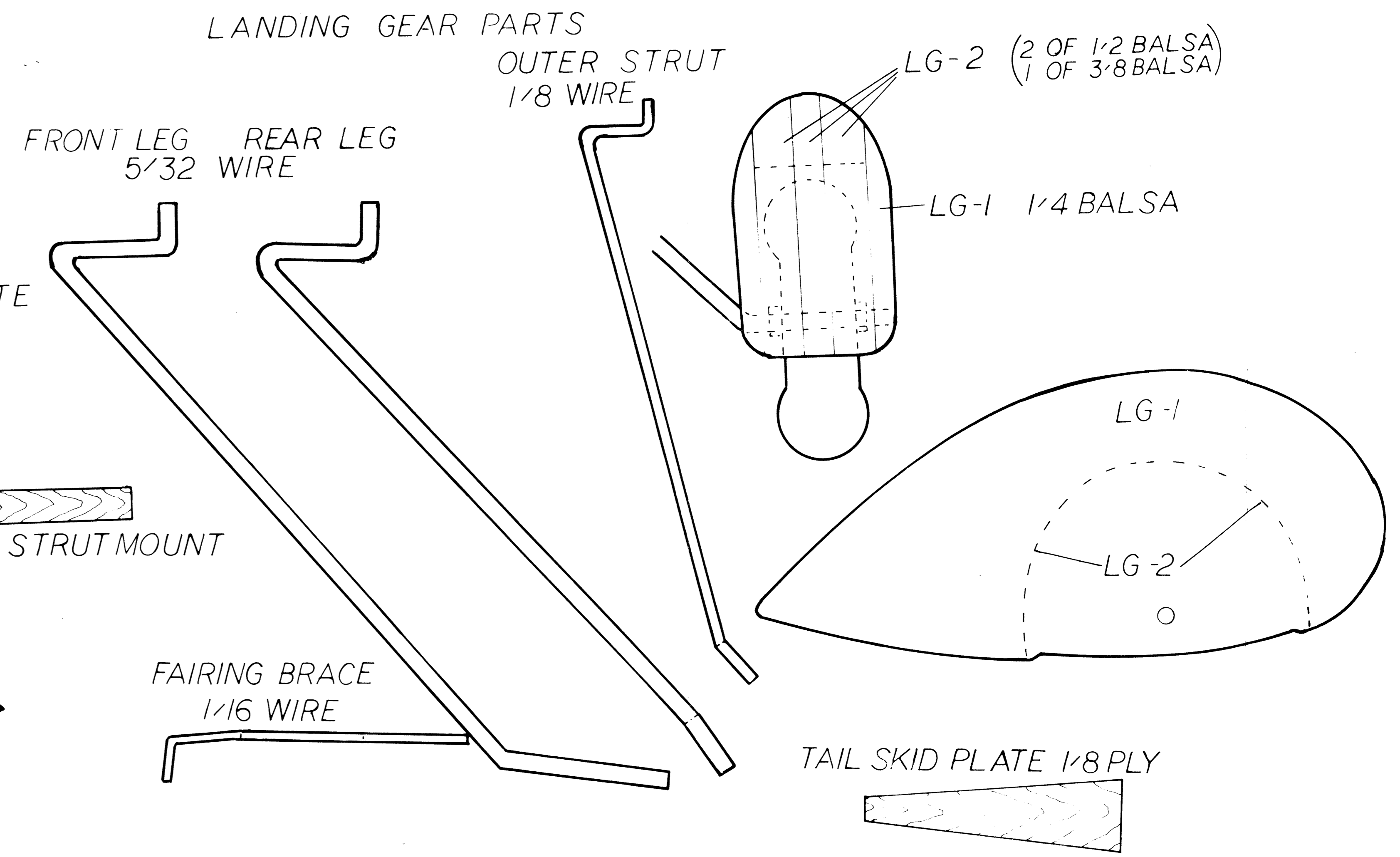
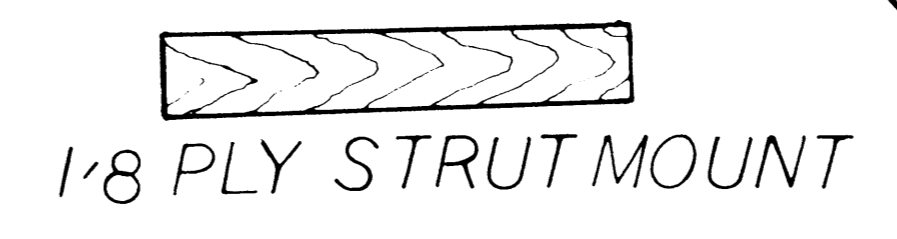
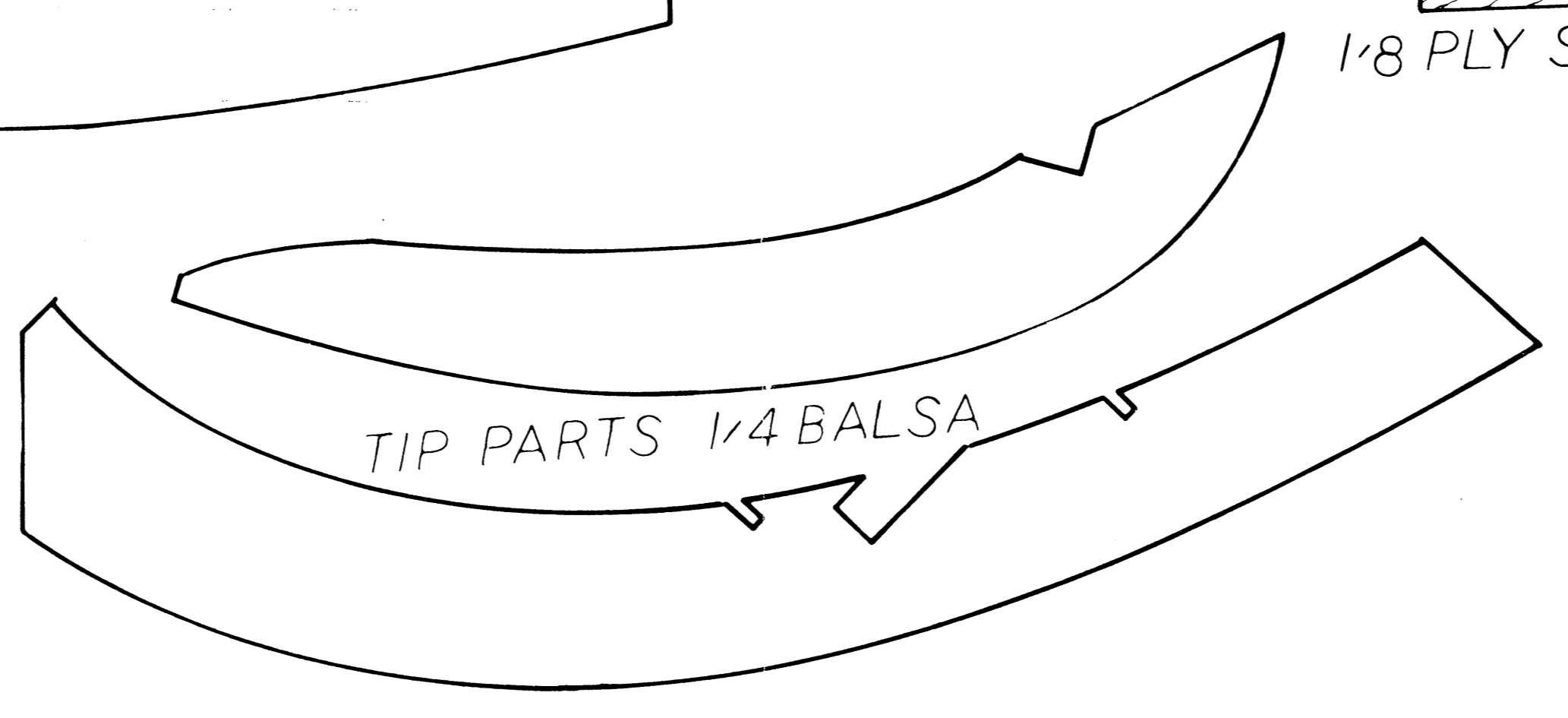
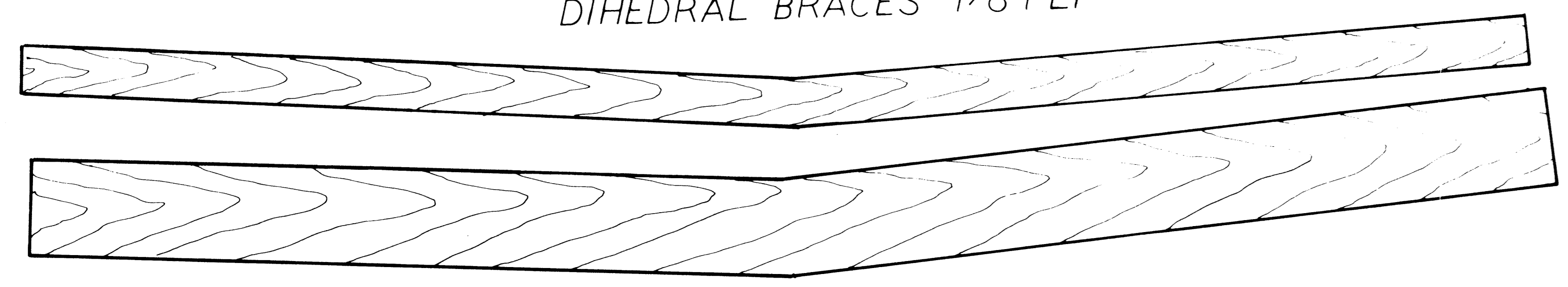

FUSELAGE FORMERS OF 1/8 Balsa EXCEPT AS NOTED

COWL FRONT
1 IN. Balsa

FIREWALL 1/4 PLY

