

DIHEDRAL, TOP WING: 1 7/8" UNDER EACH TIP

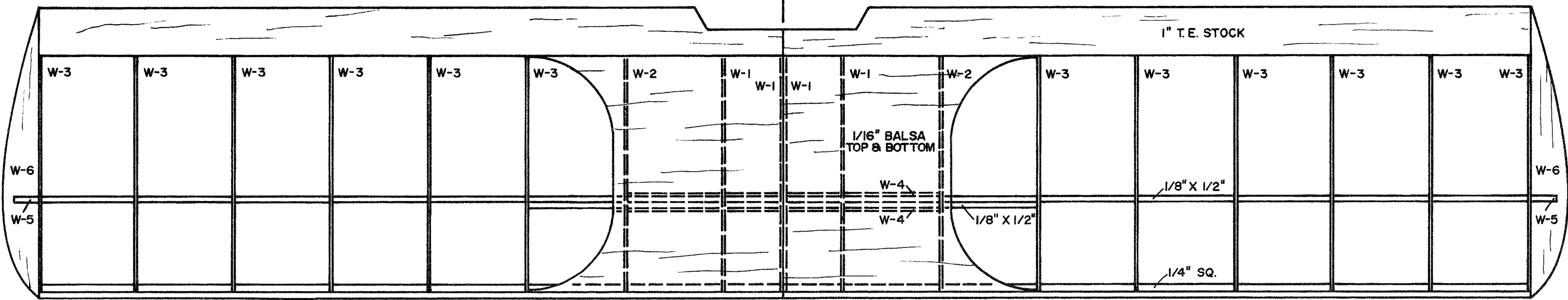

DIHEDRAL BOTTOM WING: 1 5/8" UNDER EACH TIP

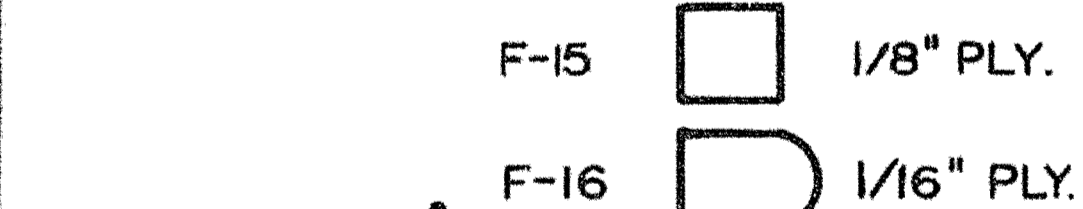
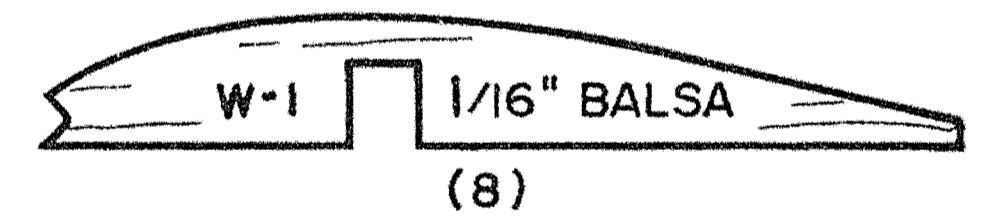
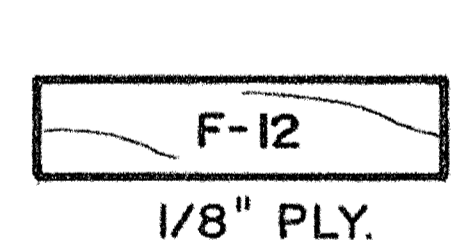
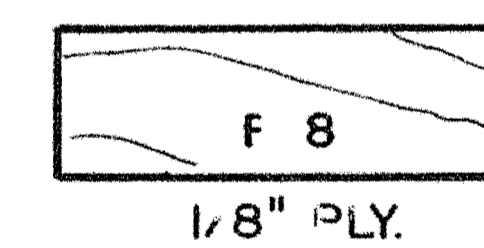
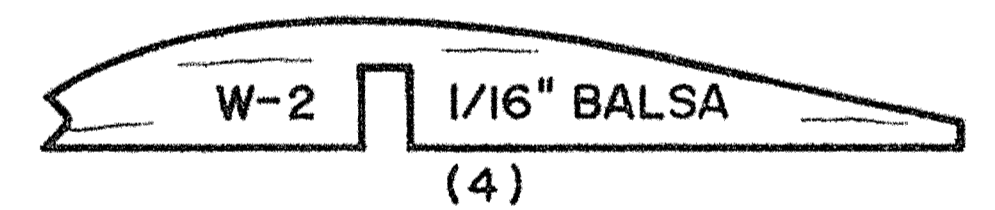
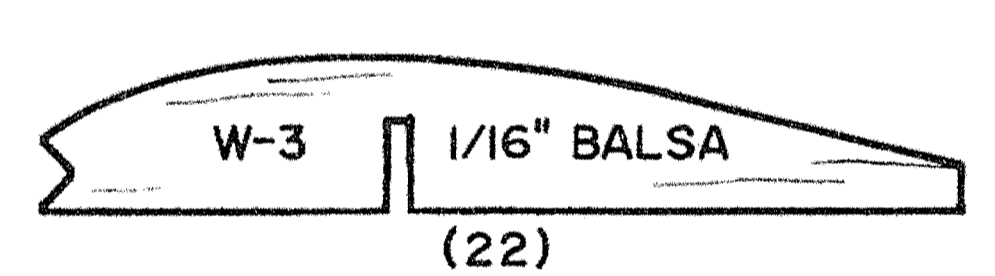
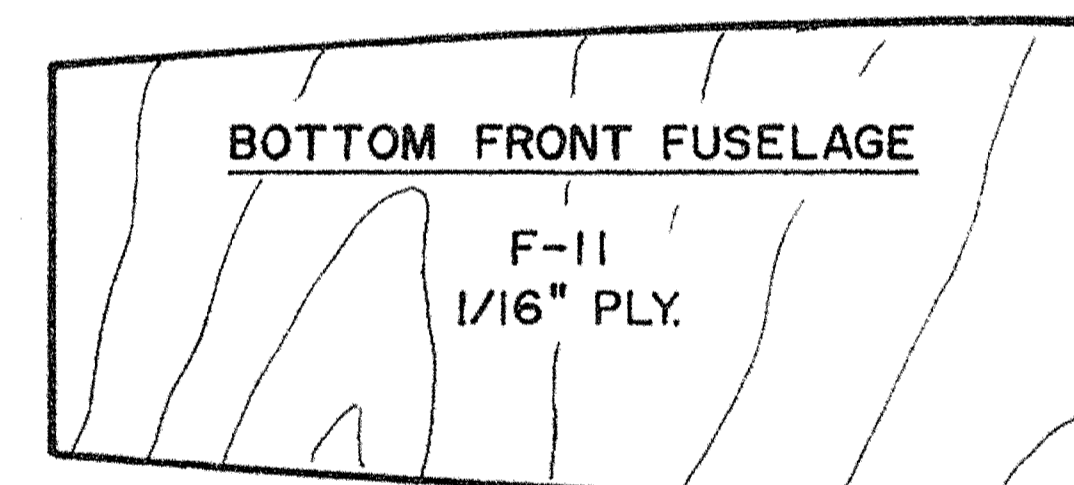
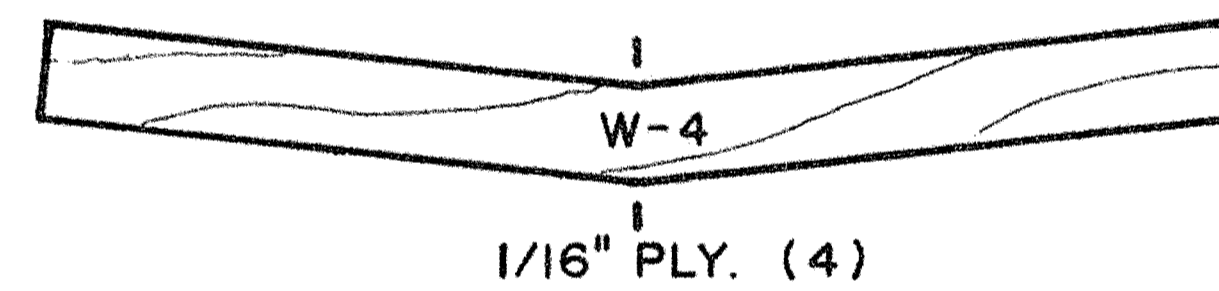
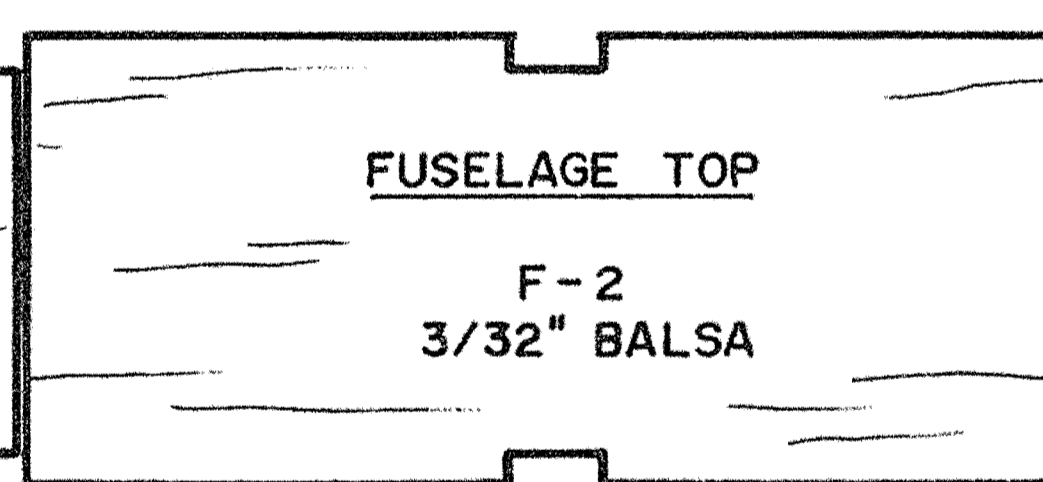
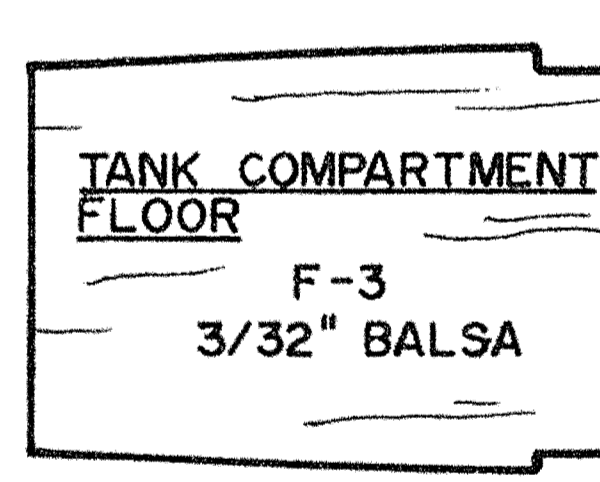
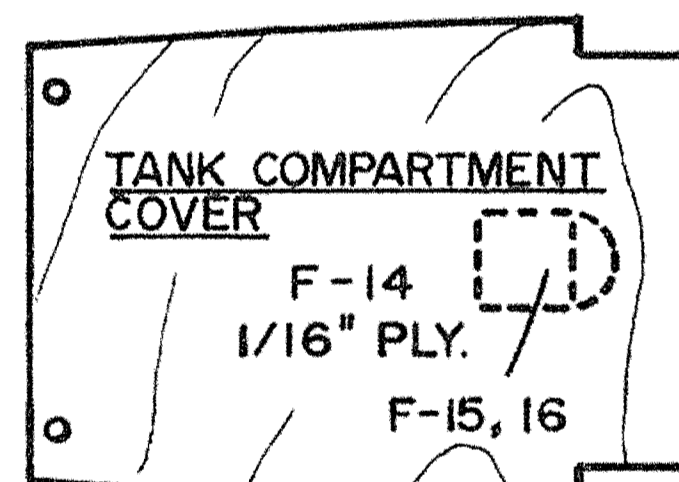
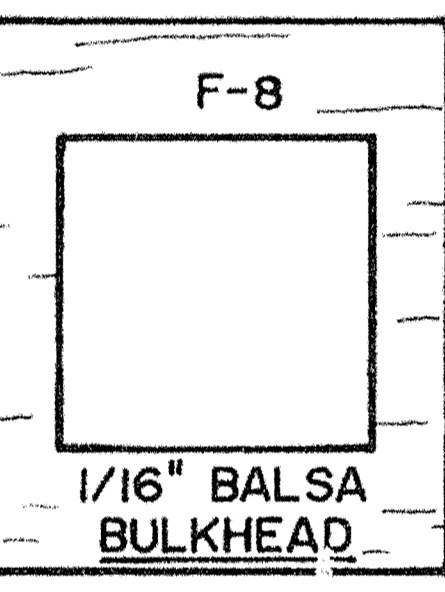
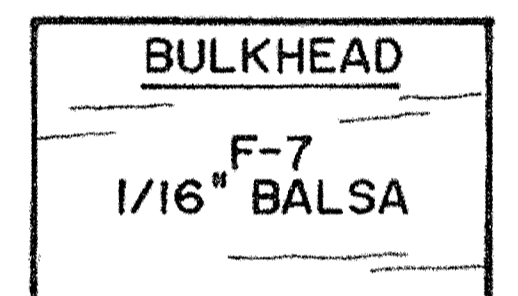
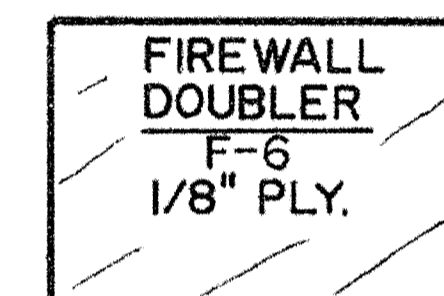
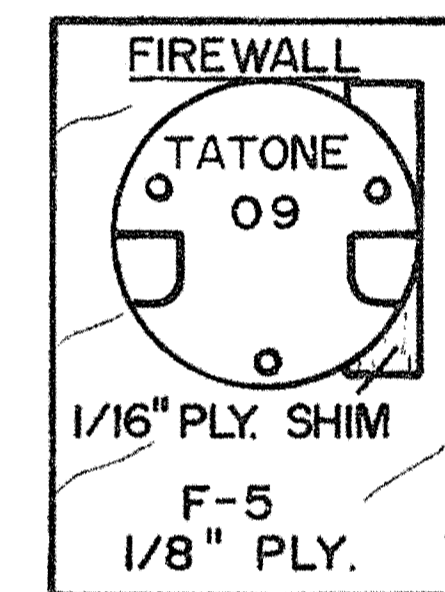
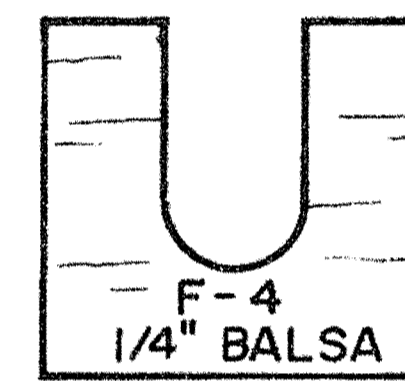
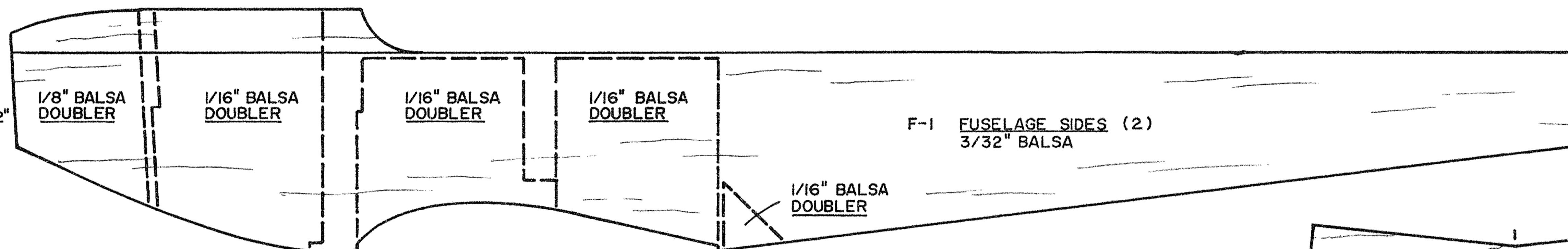
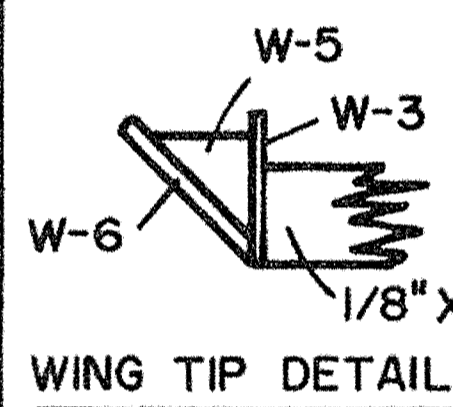
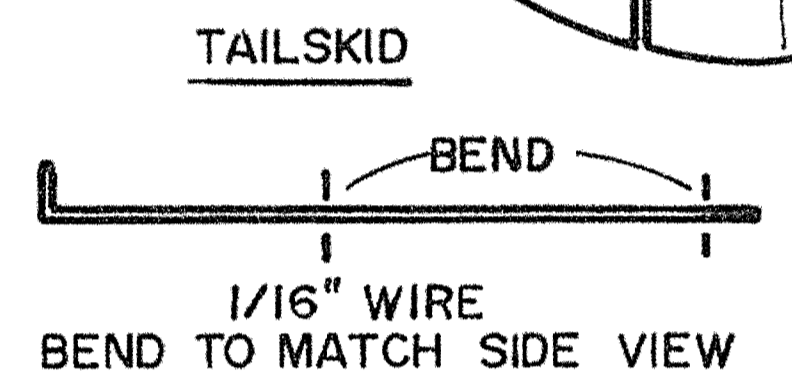
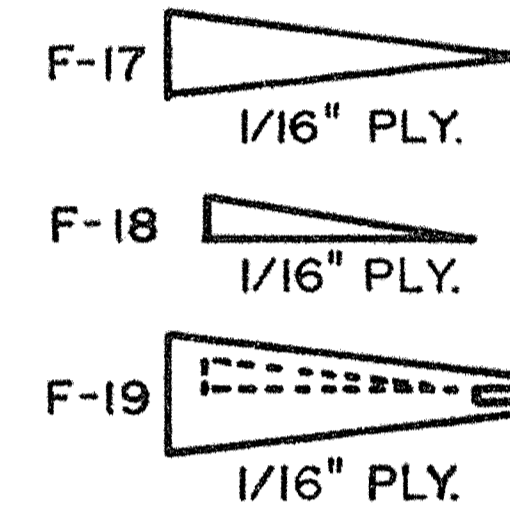
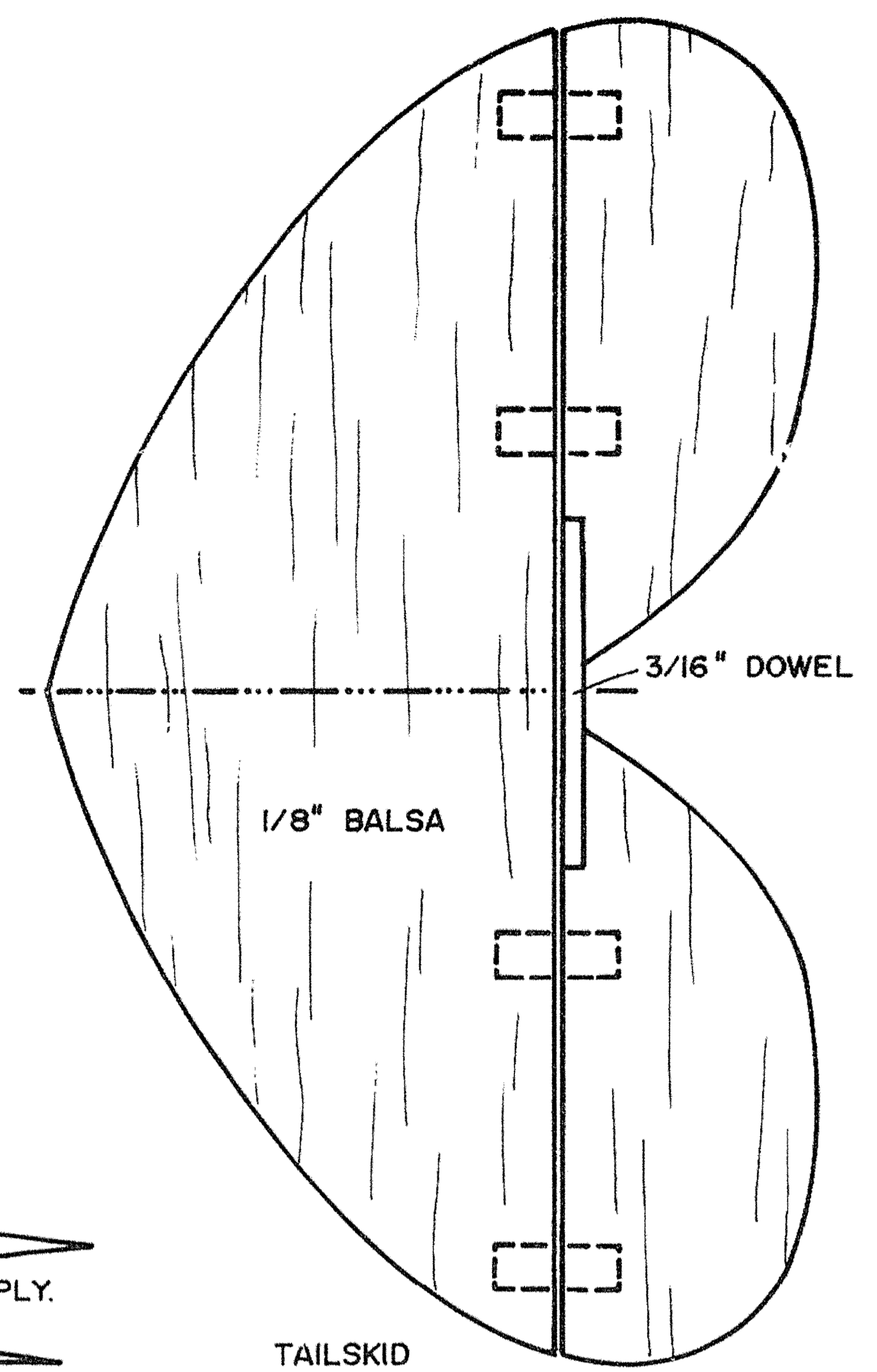
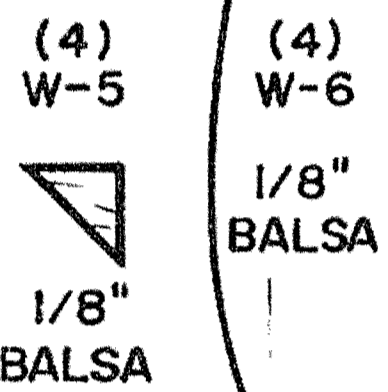
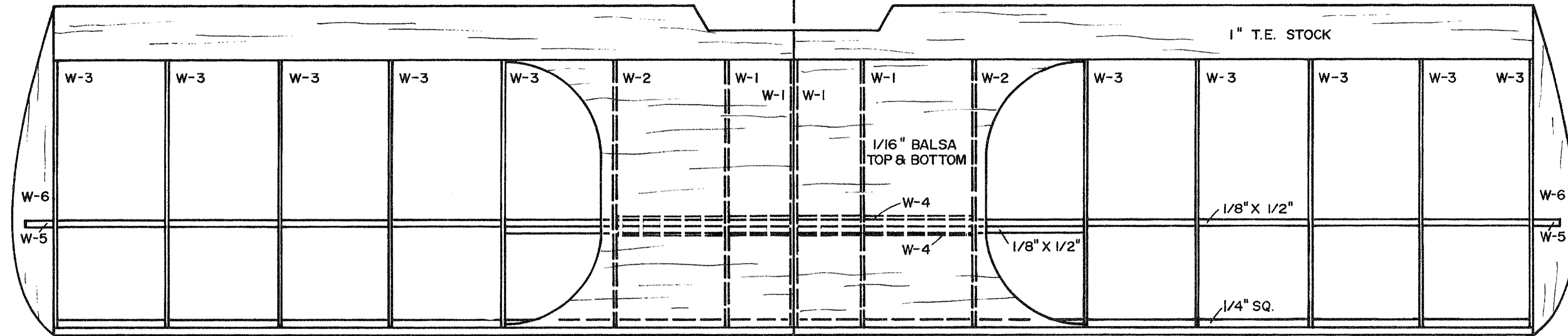

FOR .09-.10 ENGINE: COX TD .09 SHOWN

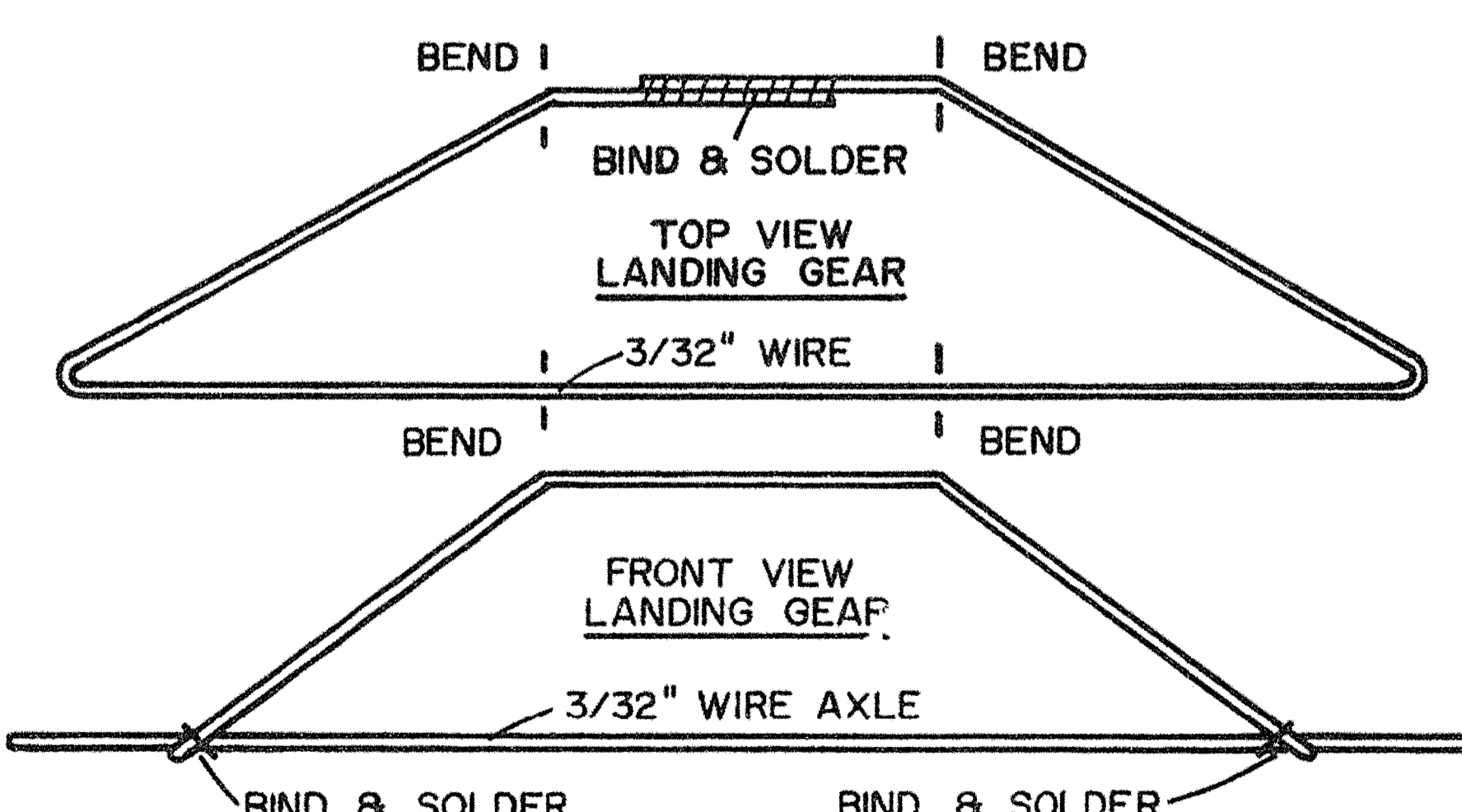
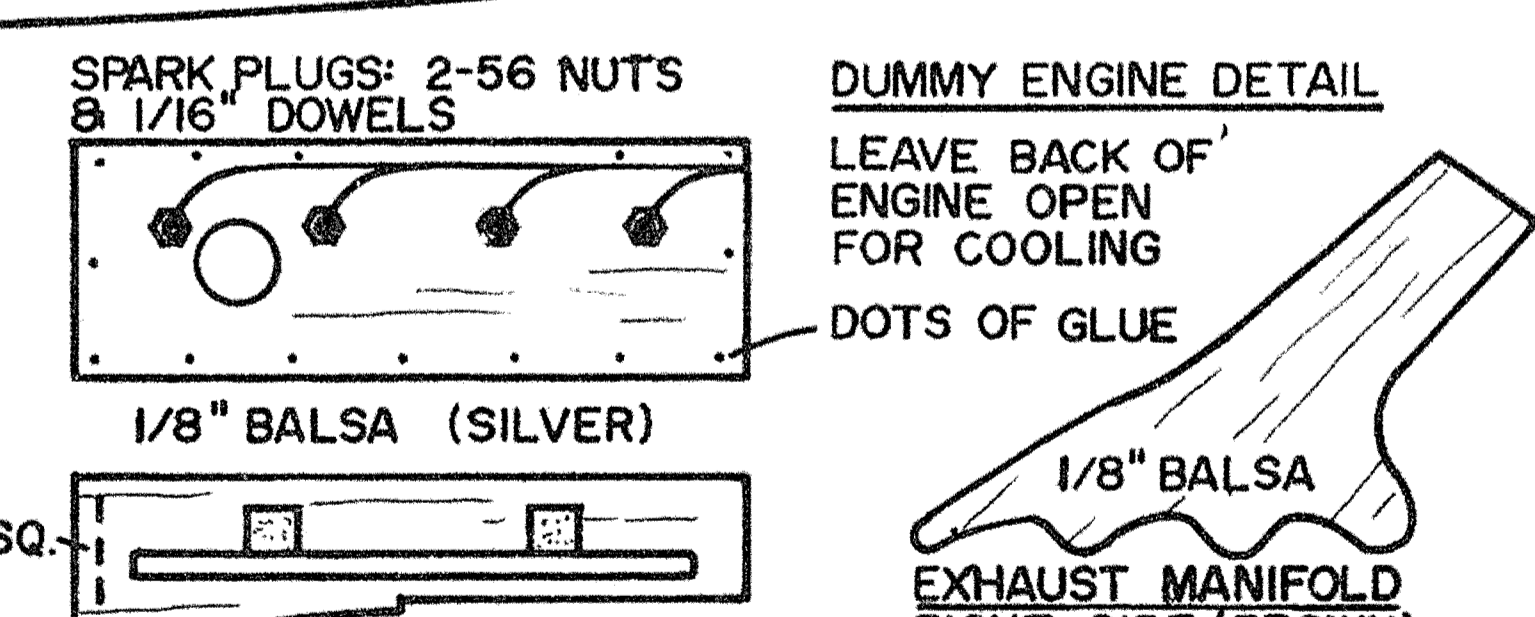
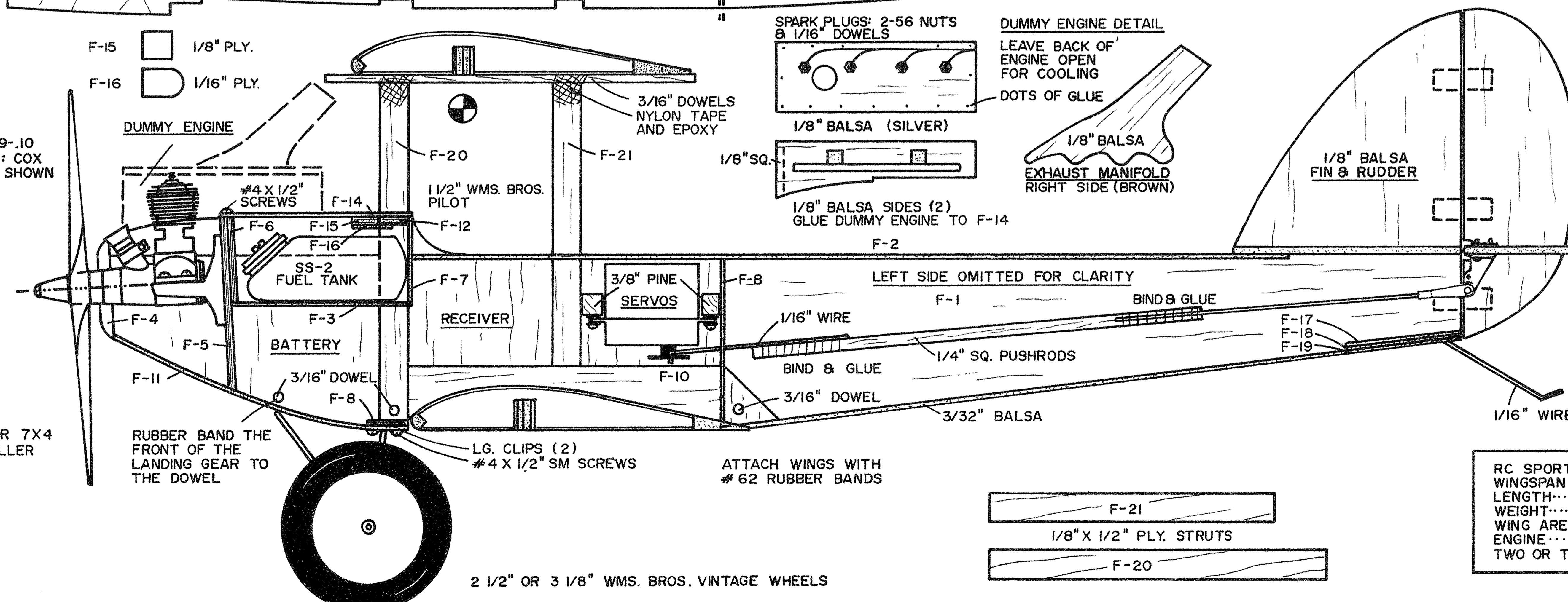

RC SPORT BIPLANE specifications table including wingspan, length, weight, wing area, engine, and radio type.



DOPPELDECKER logo and text.

DESIGNED AND DRAWN BY FRED REESE

By H.E.

