

NOTE: SLANT BOTH NUMBER 1 RIBS TO CONFORM TO THE DIHEDRAL ANGLE OF THE SPAR

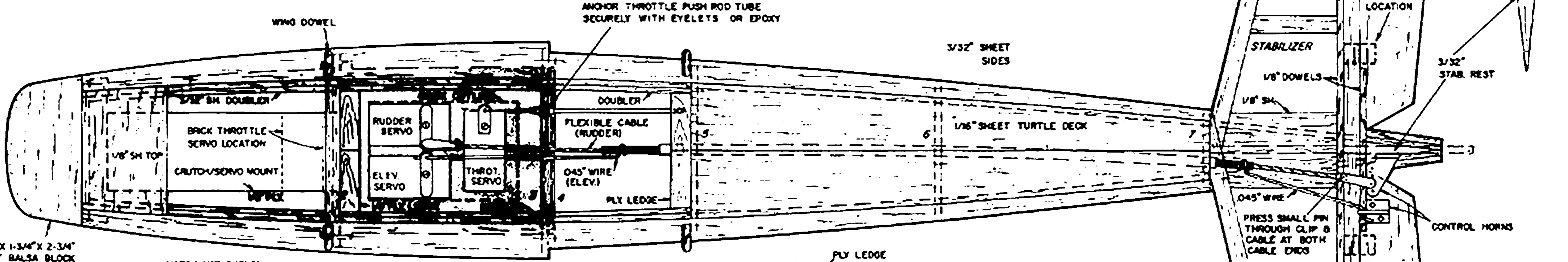

1-1/2" x 1-3/4" x 2-3/4" SOFT Balsa BLOCK

HATCH NOT SHOWN IN TOP VIEW

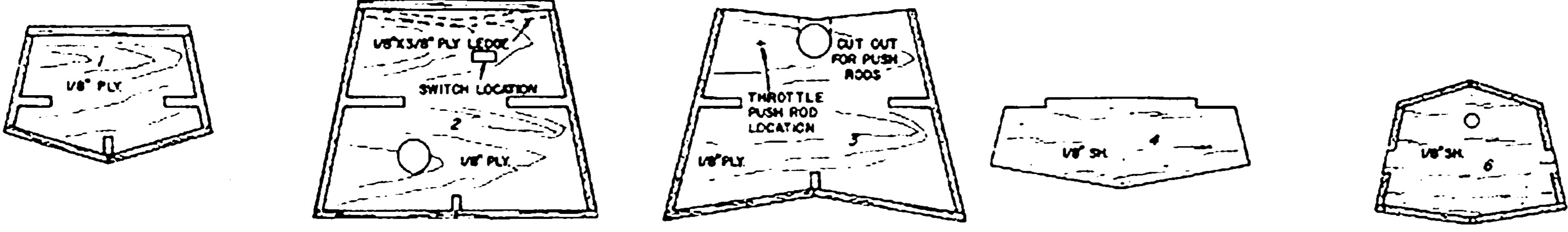
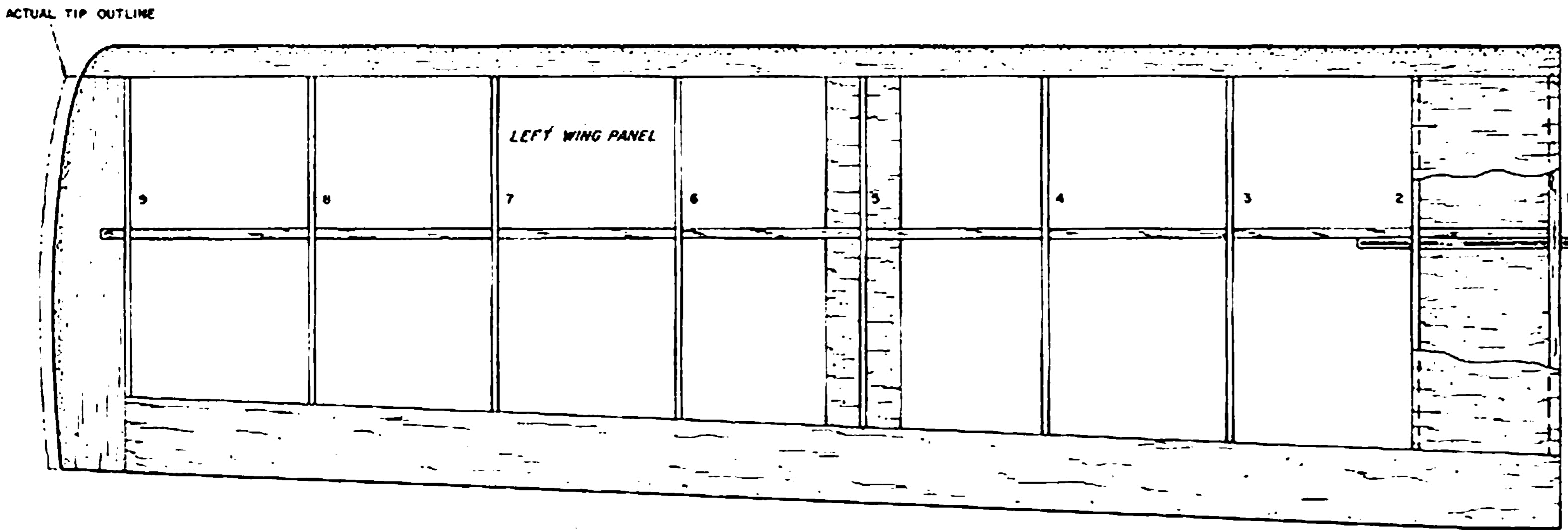
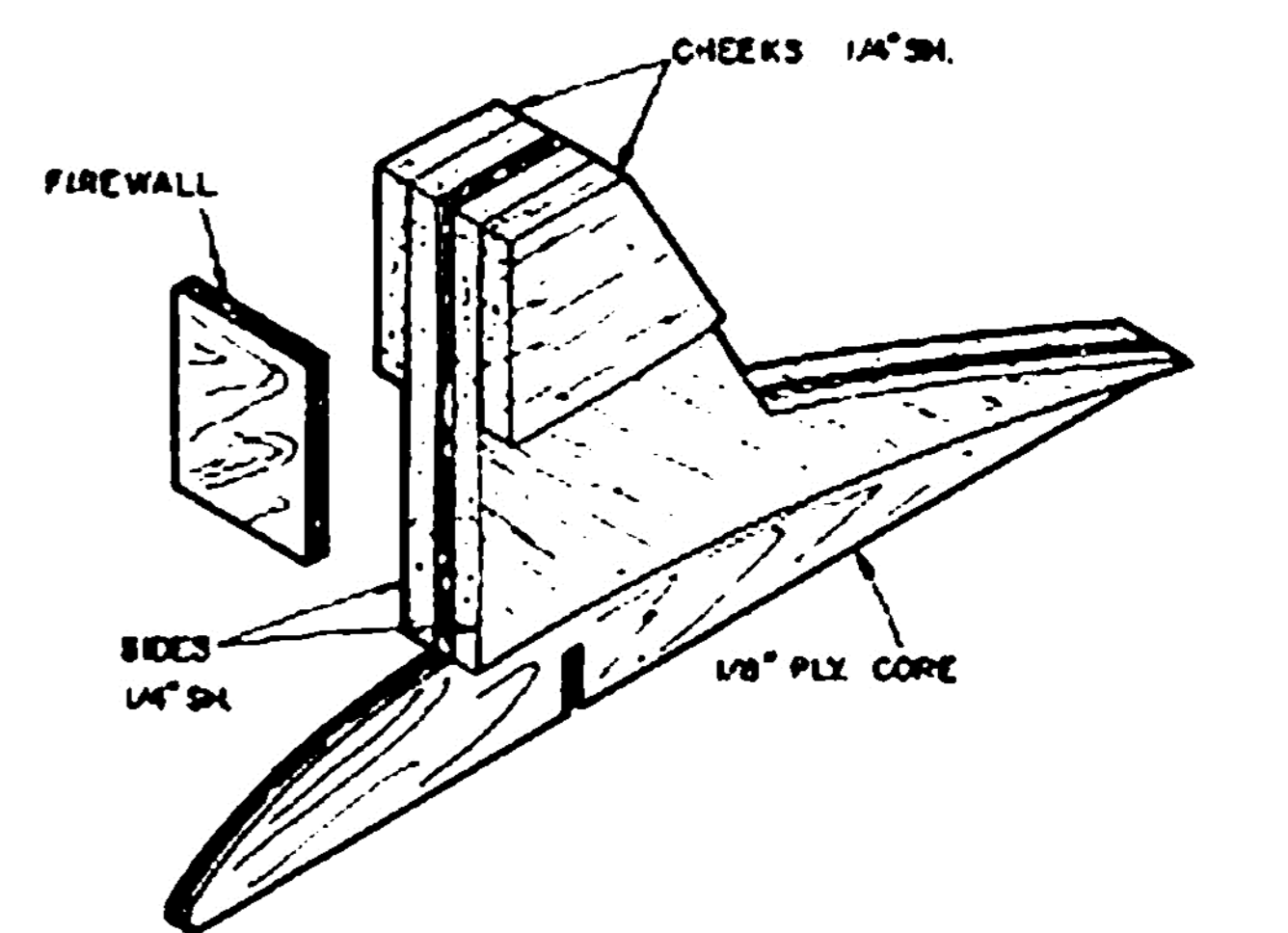
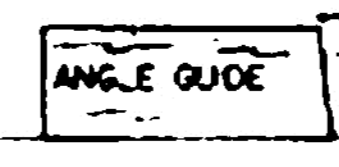
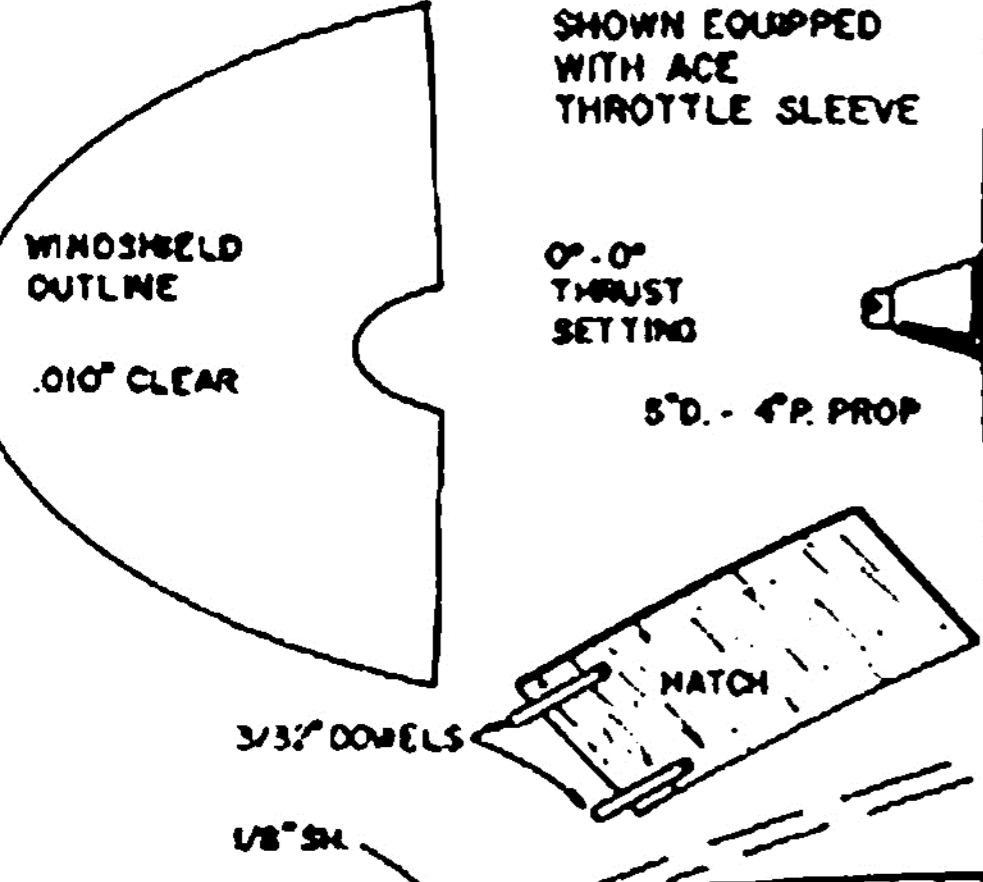
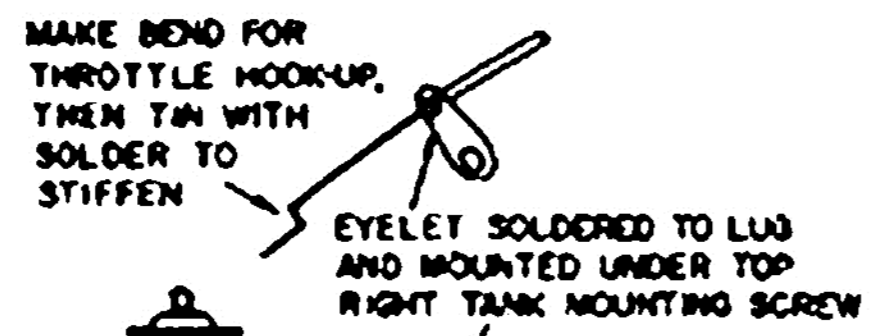

ted strader's
Corky II 1/2A 3CH RC
sea plane

