

# KEILKRAFT KITS PRESENT... The FALCON

AN 8 FT. SPAN MODEL FOR DIESEL OR PETROL ENGINES 10-15 C.C.






# The FALCON

**KEIL KRAFT KITS**

E. KEIL & CO. LTD. LONDON E.2

COVER PLAN WITH WAXED PAPER TO FACILITATE EASY REMOVAL OF ASSEMBLED PARTS



SHEET 2 OF 3 SHEETS. SEE SHEET 3 FOR FURTHER INFORMATION - RIBS ETC...

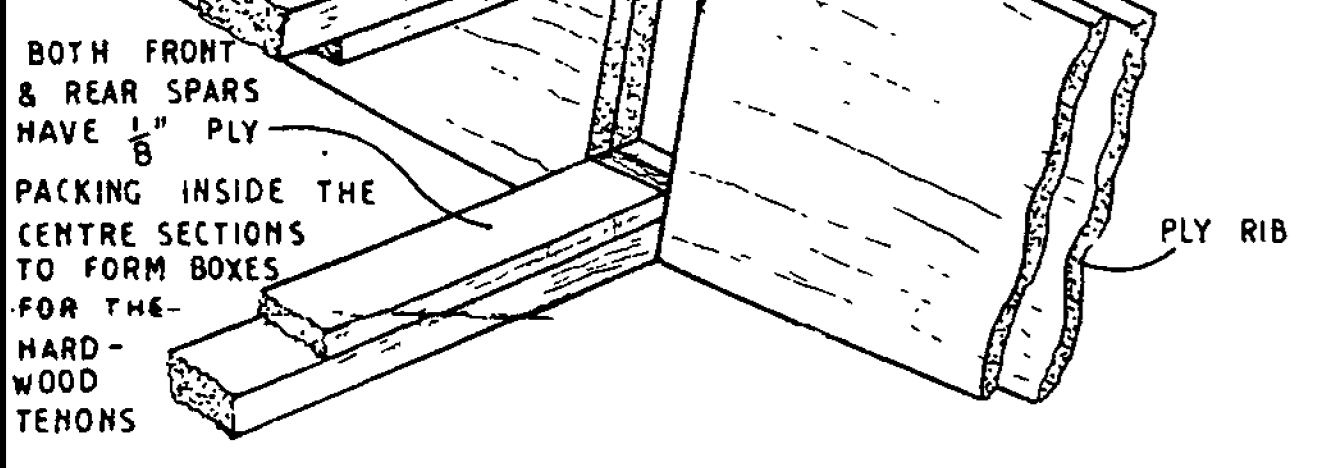

DOTTED LINE INDICATES 1 1/2 x 1/16 TRAILING EDGE CONTINUE TO TIP AS SHOWN

1 1/2 x 1/16 TRAILING EDGE ABOVE & BELOW SANDPAPER "FALSE" T.E. & TIPS TO A KNIFE EDGE BEFORE ADDING SHEET COVERING OR TRAILING EDGE PROPER.

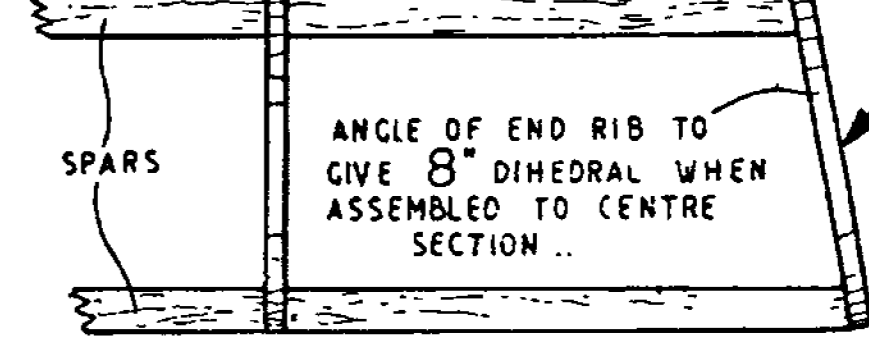

ACTUAL SIZE OF BOX. MAKE FROM 1/8 PLY. BIND WITH SILK BEFORE INSTALLING.

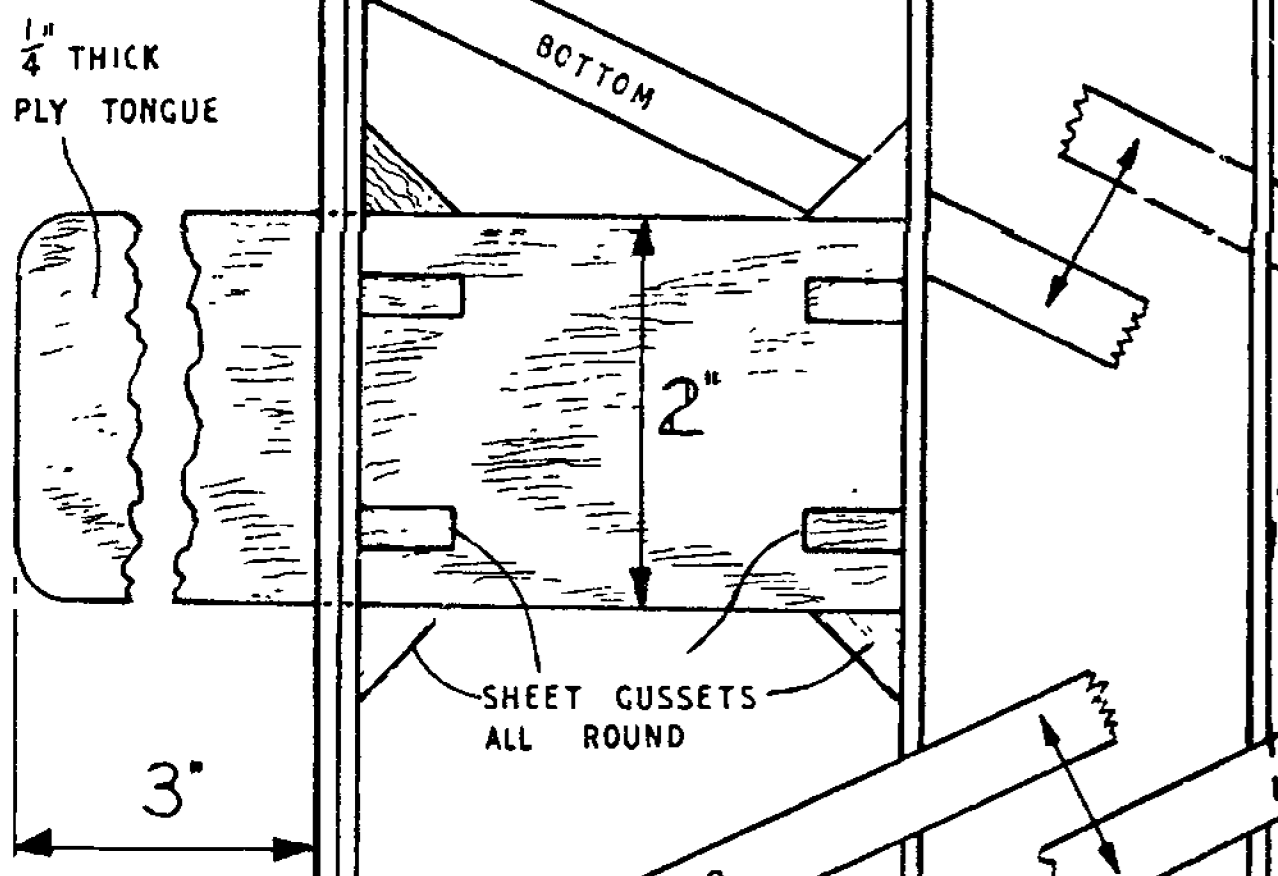


THESE DIAGONALS ARE LET INTO RIBS AFTER ASSEMBLY OF CENTRE SECTION TO MAIN WING PANEL.

1/4 x 1/16 CAP STRIPS ON UPPER & LOWER SURFACES OF RIBS

CONTINUE TRAILING EDGE TO TIP AS SHOWN HERE DOTTED.

GET THE KEIL KRAFT HANDBOOK FOR USEFUL DATA ON PETROL MODELS & ENGINES.

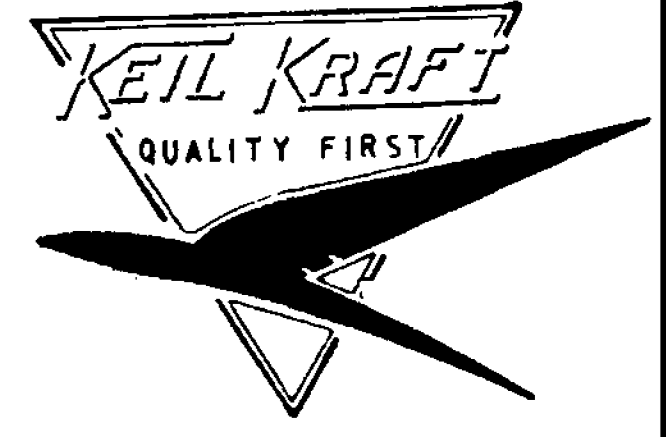

# The FALCON

**KEIL KRAFT KITS**

E. KEIL & CO. LTD. LONDON. E.9

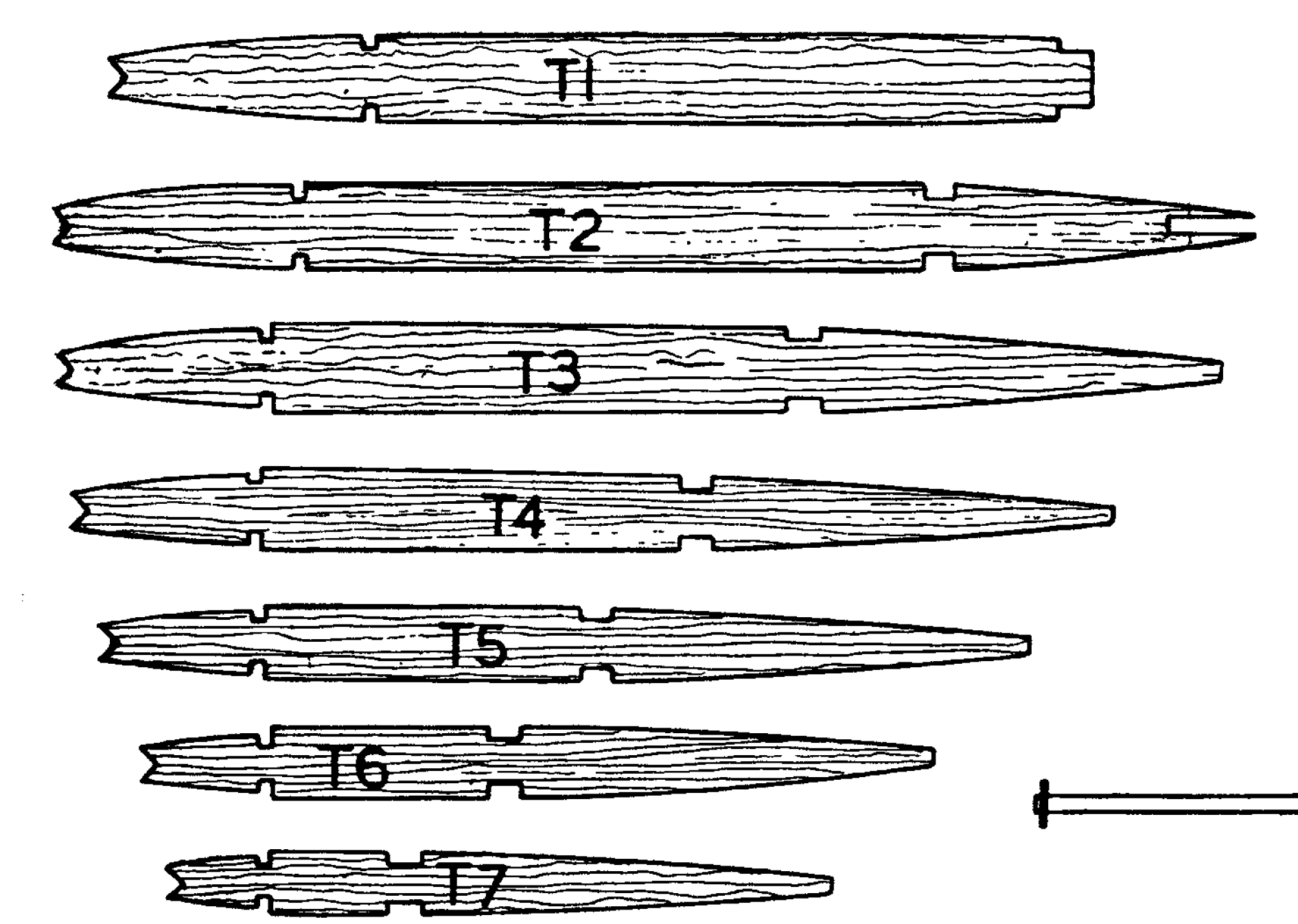
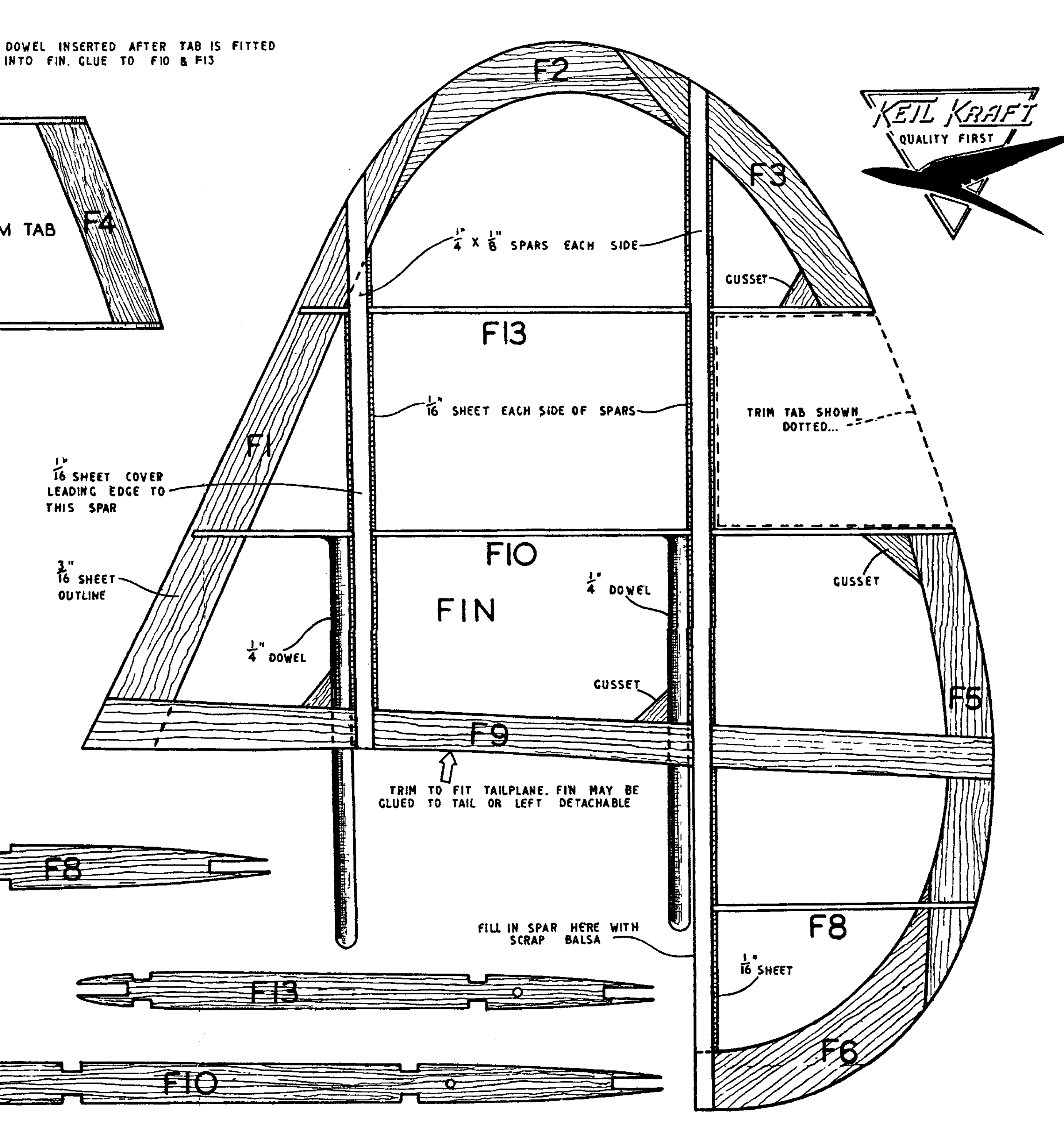
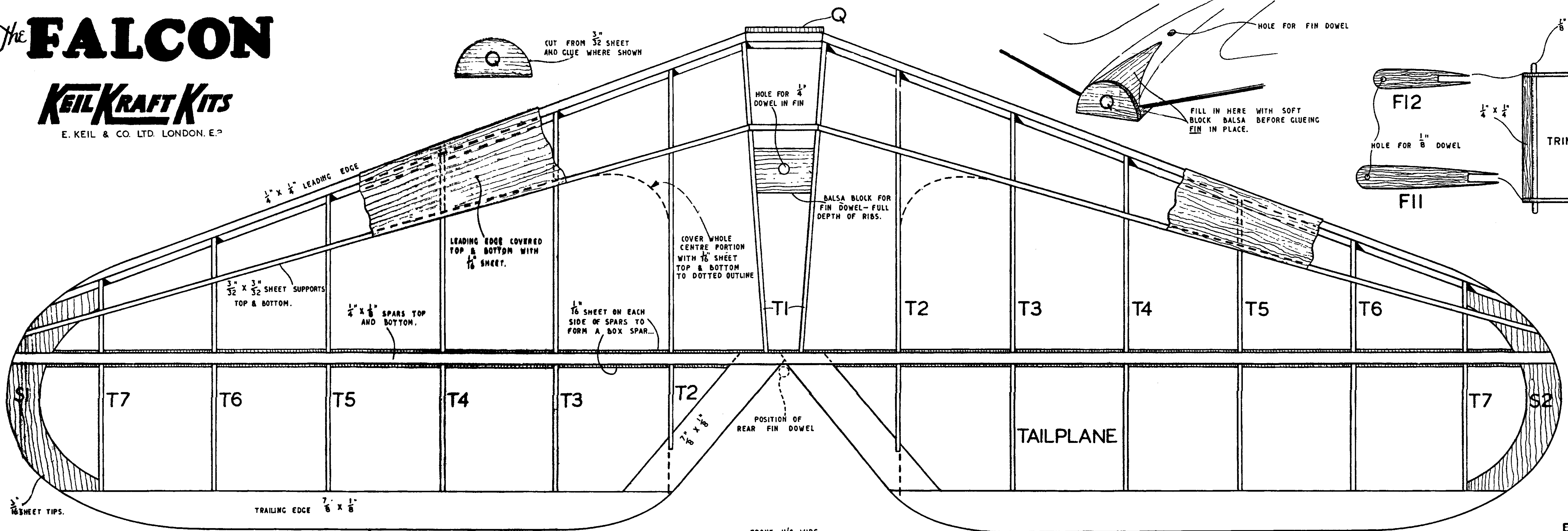
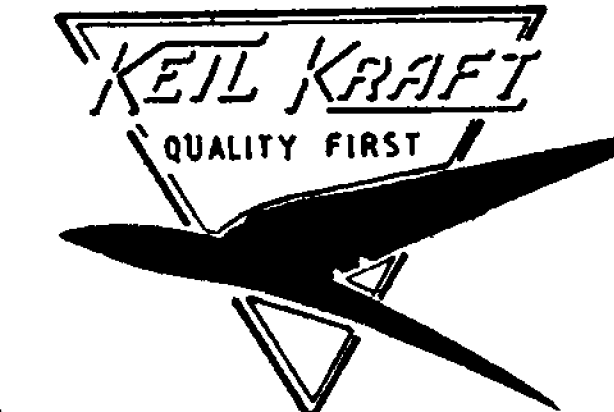

TAILPLANE & FIN COVERED WITH LIGHT SILK OR BAMBOO PAPER

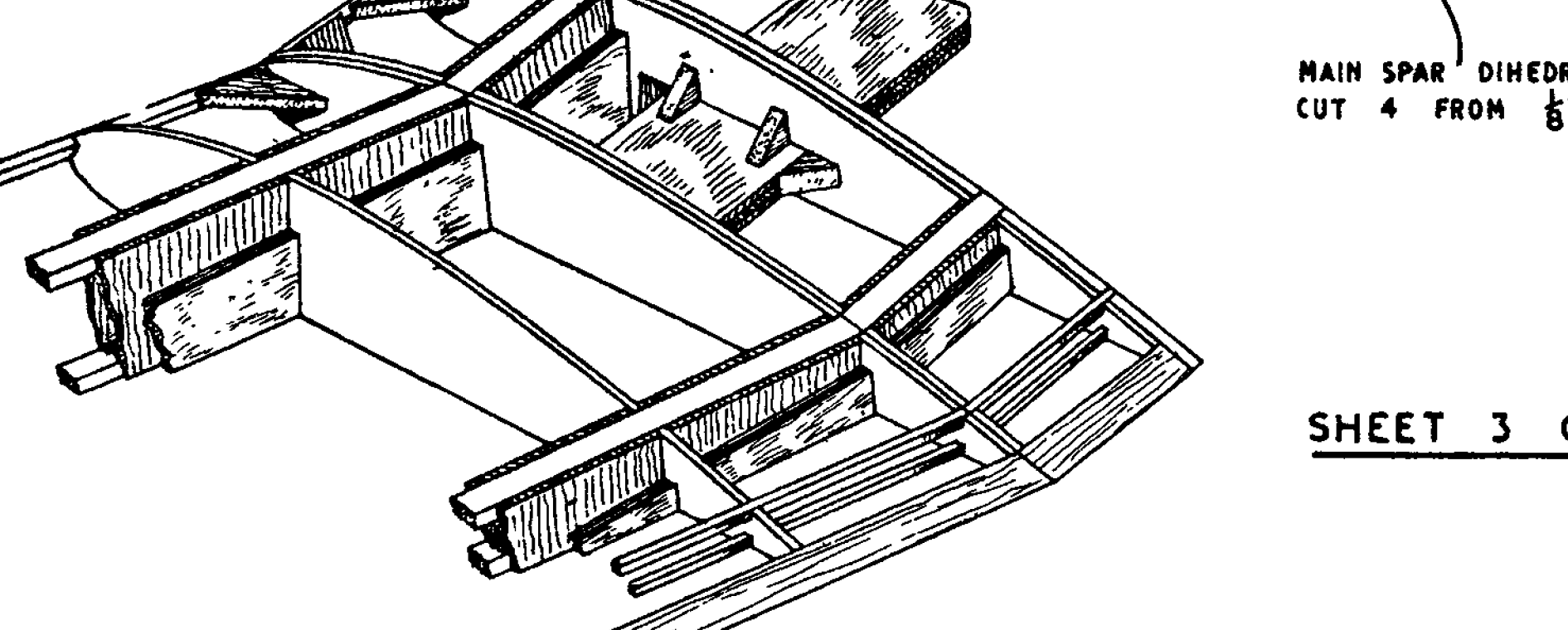
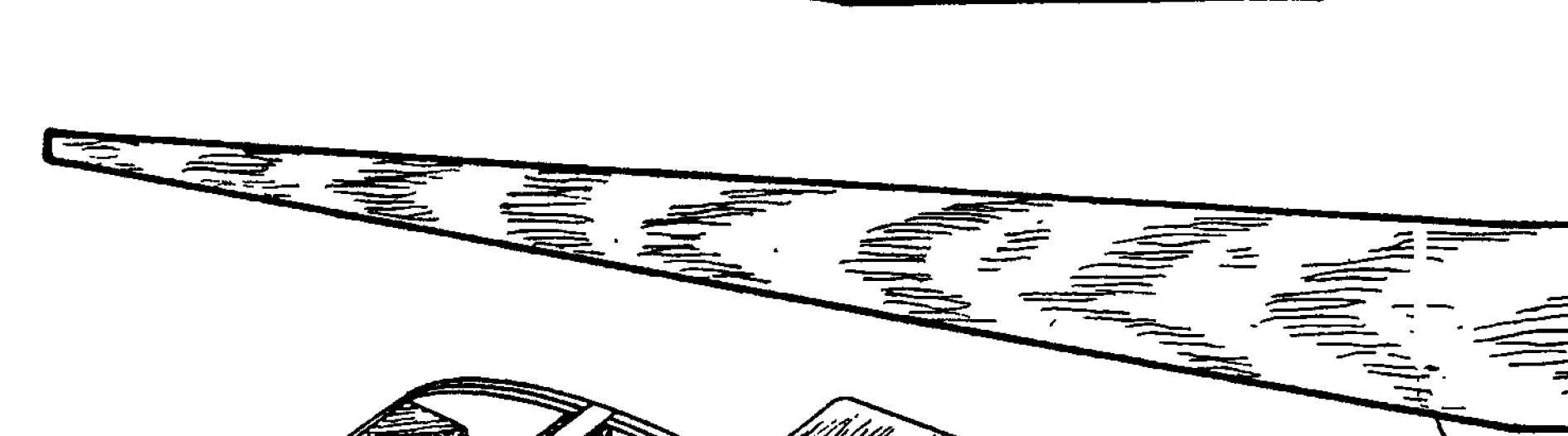
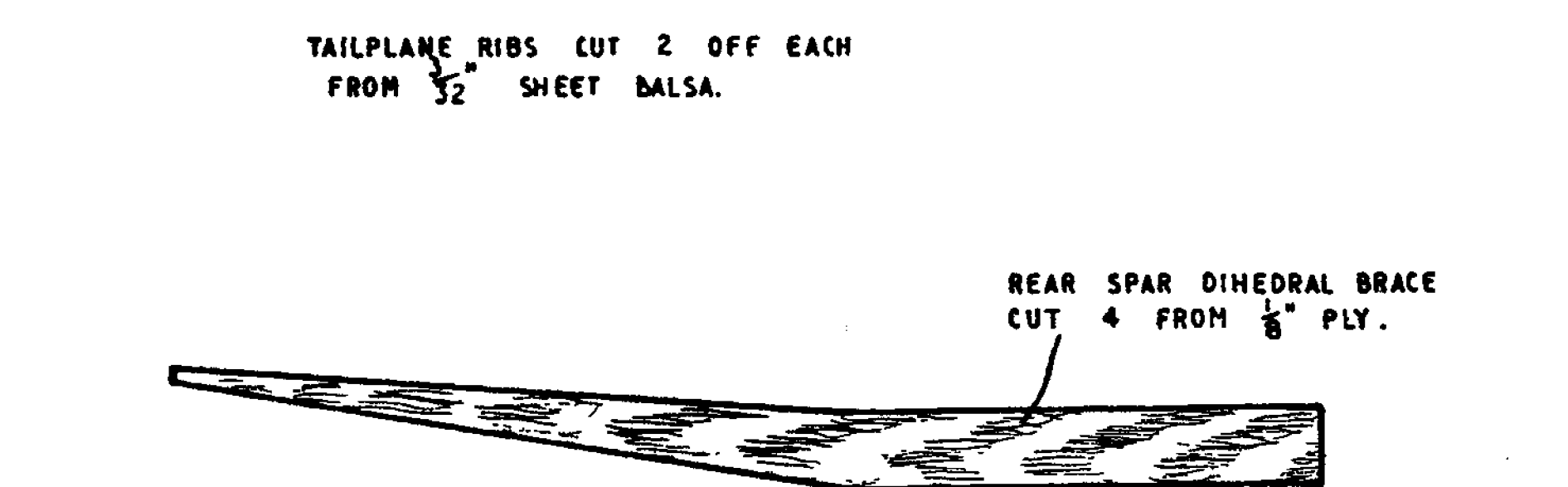

SHEET 3 OF 3 SHEETS

