

NOTE:
FORMERS A, B, C, D1,
D2, E1 AND E2 ARE 1/16" PLY
FORMERS F, G, H AND I
ARE 1/16" Balsa

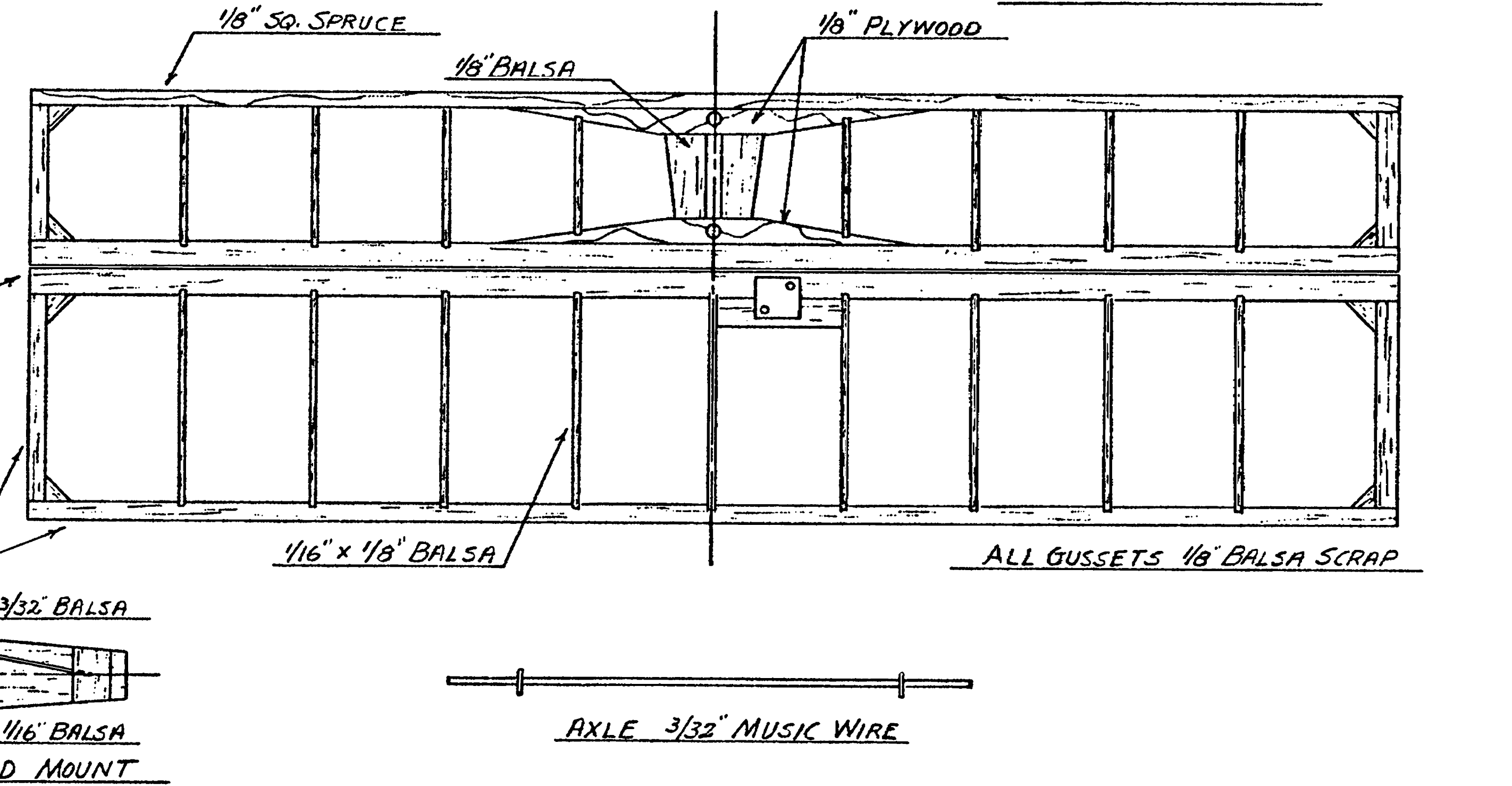
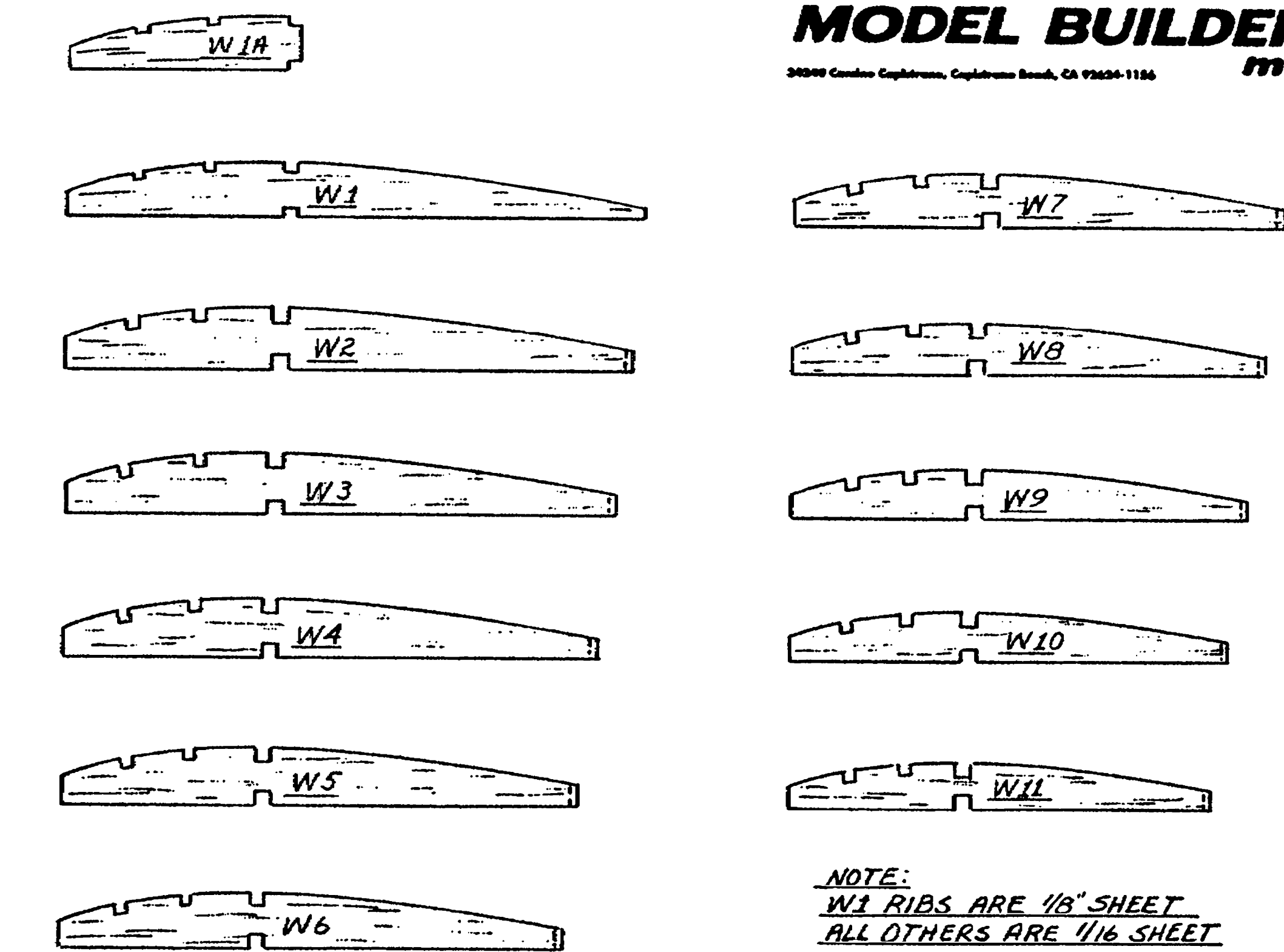
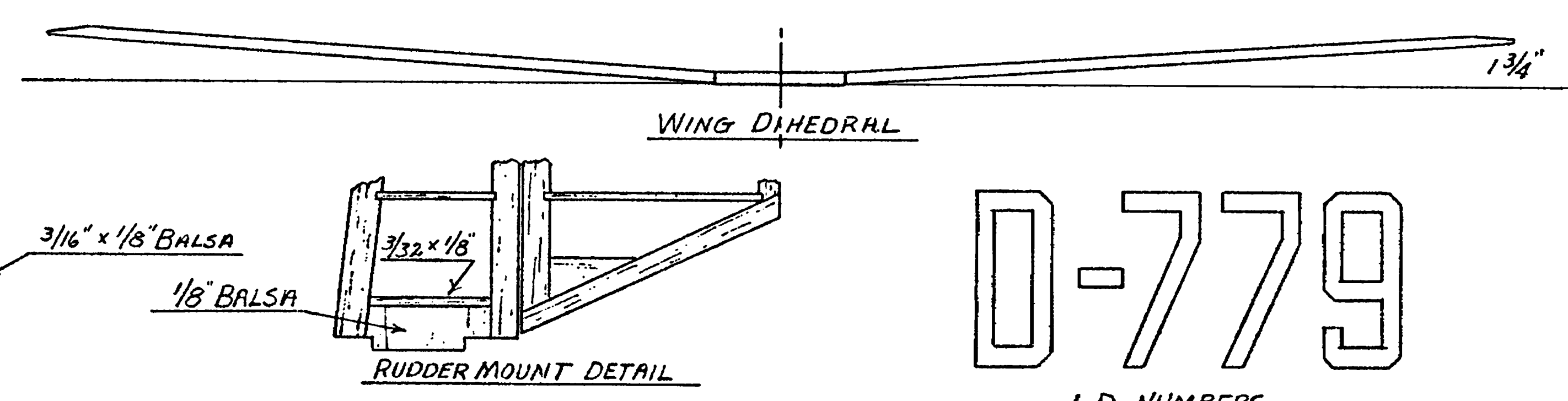
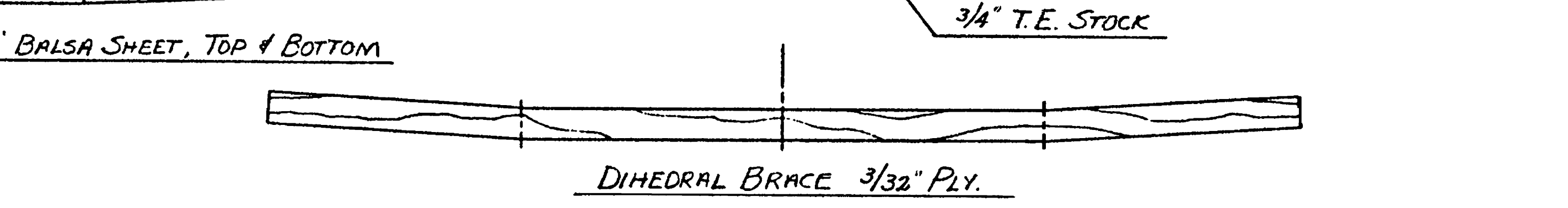
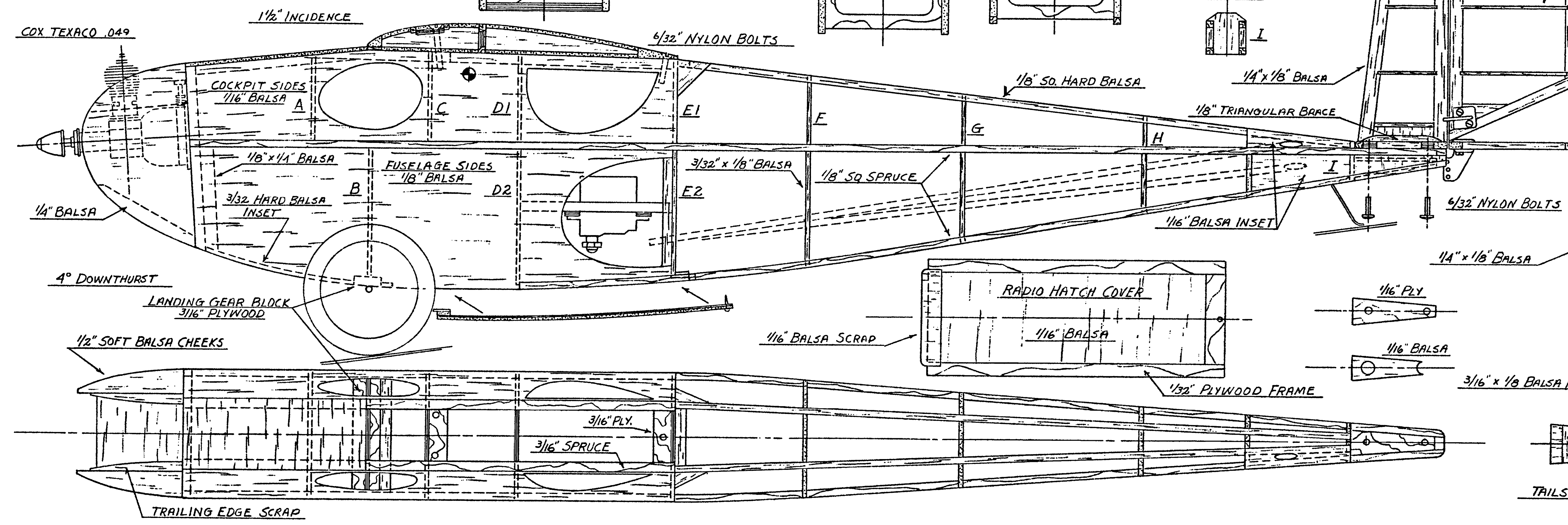
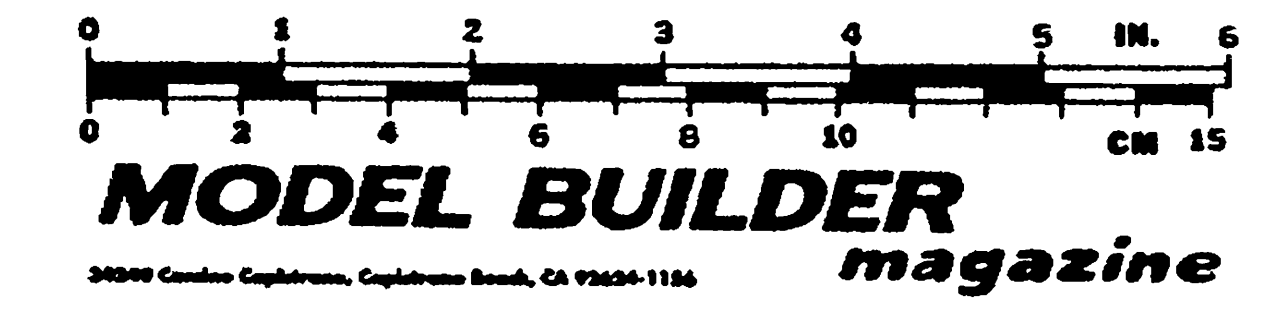
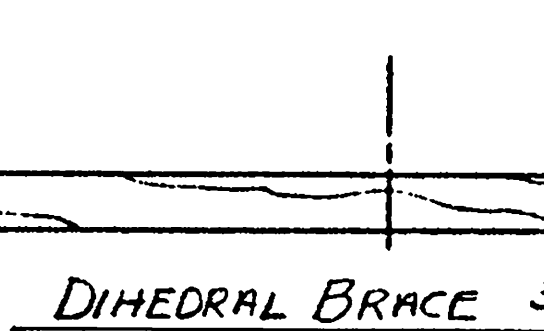
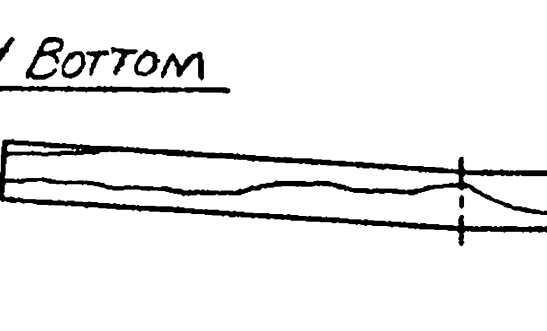
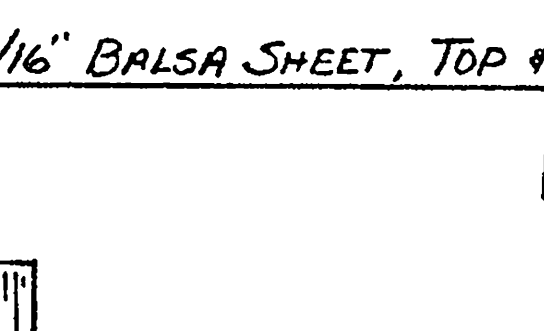
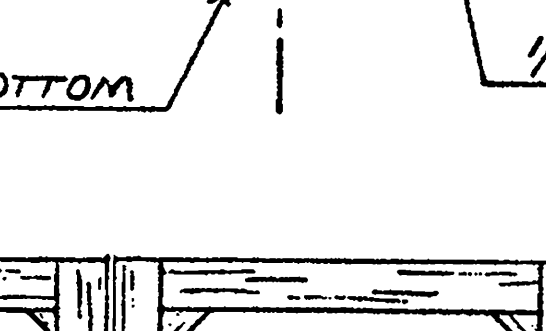
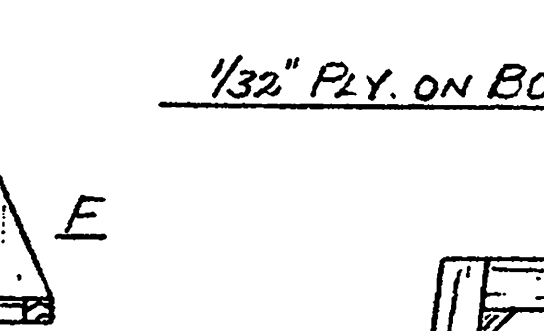
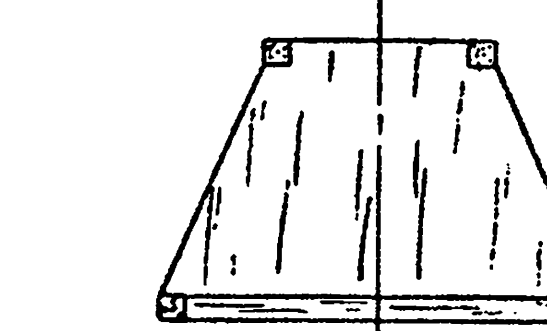
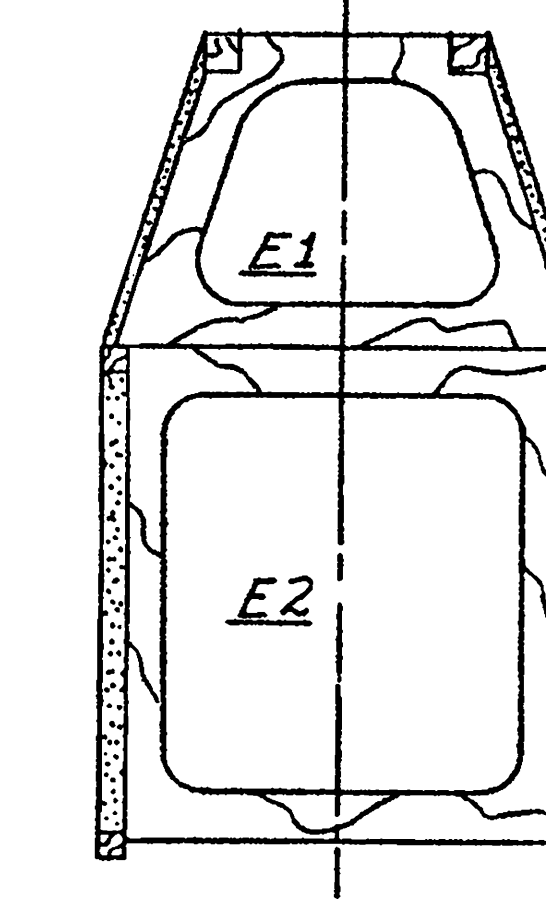
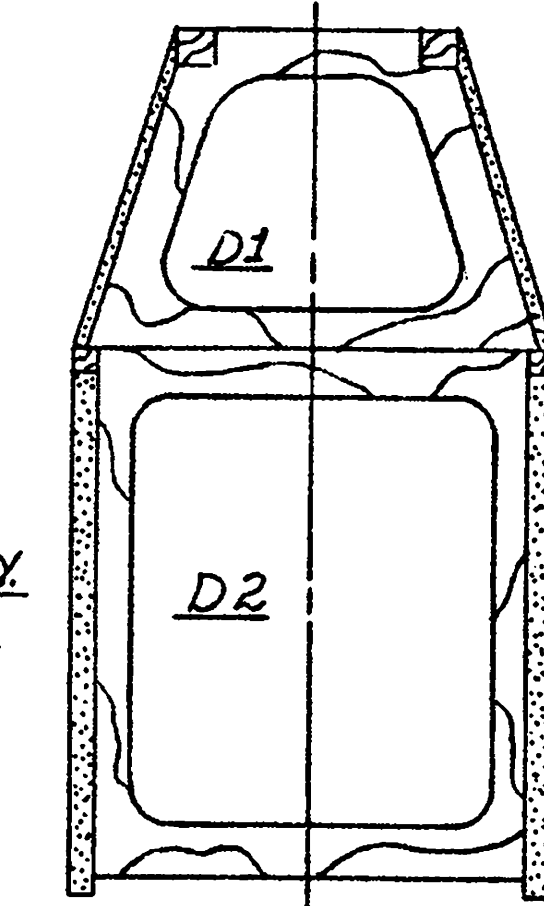
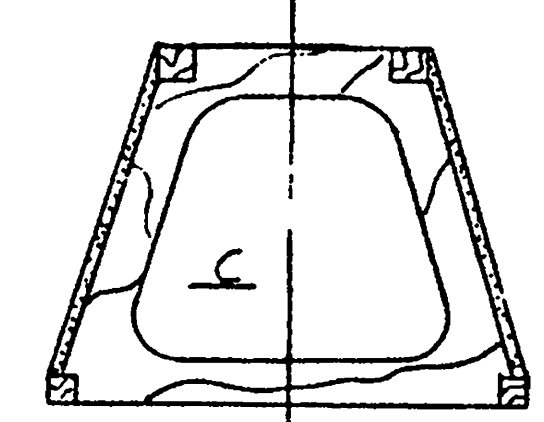

1925 MESSERSCHMITT M. 17
 FOR R.C. 1/2A SCALE DURATION
 BY VAN HEREFORD
 WING SPAN 59" WING AREA 290 sq in
 FUSELAGE 26 1/2" WEIGHT 16.2 oz.
 12/28/92