

Laminate flying surface curved edges from 3 layers of 1/32 X 3/32

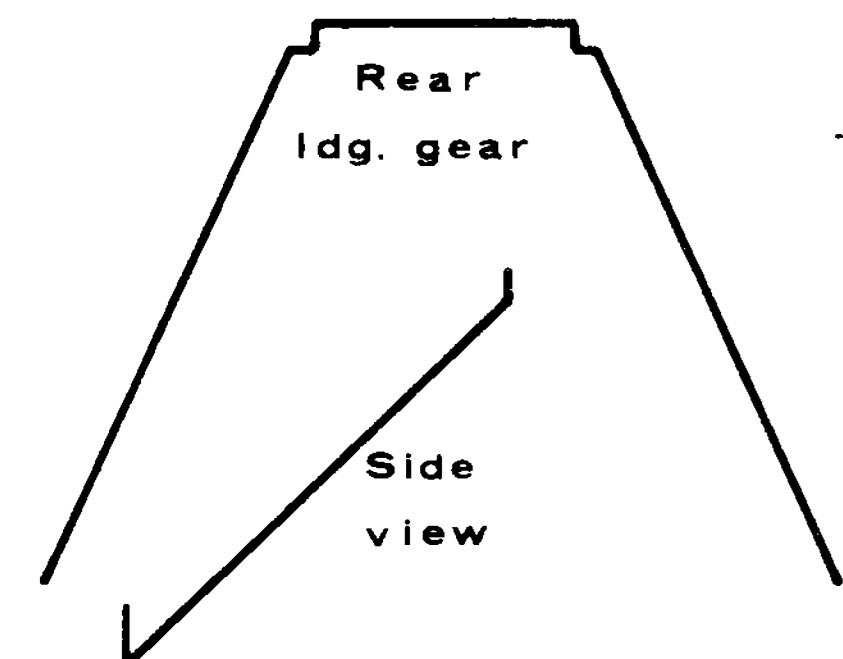

- Extends to aft end of rudder

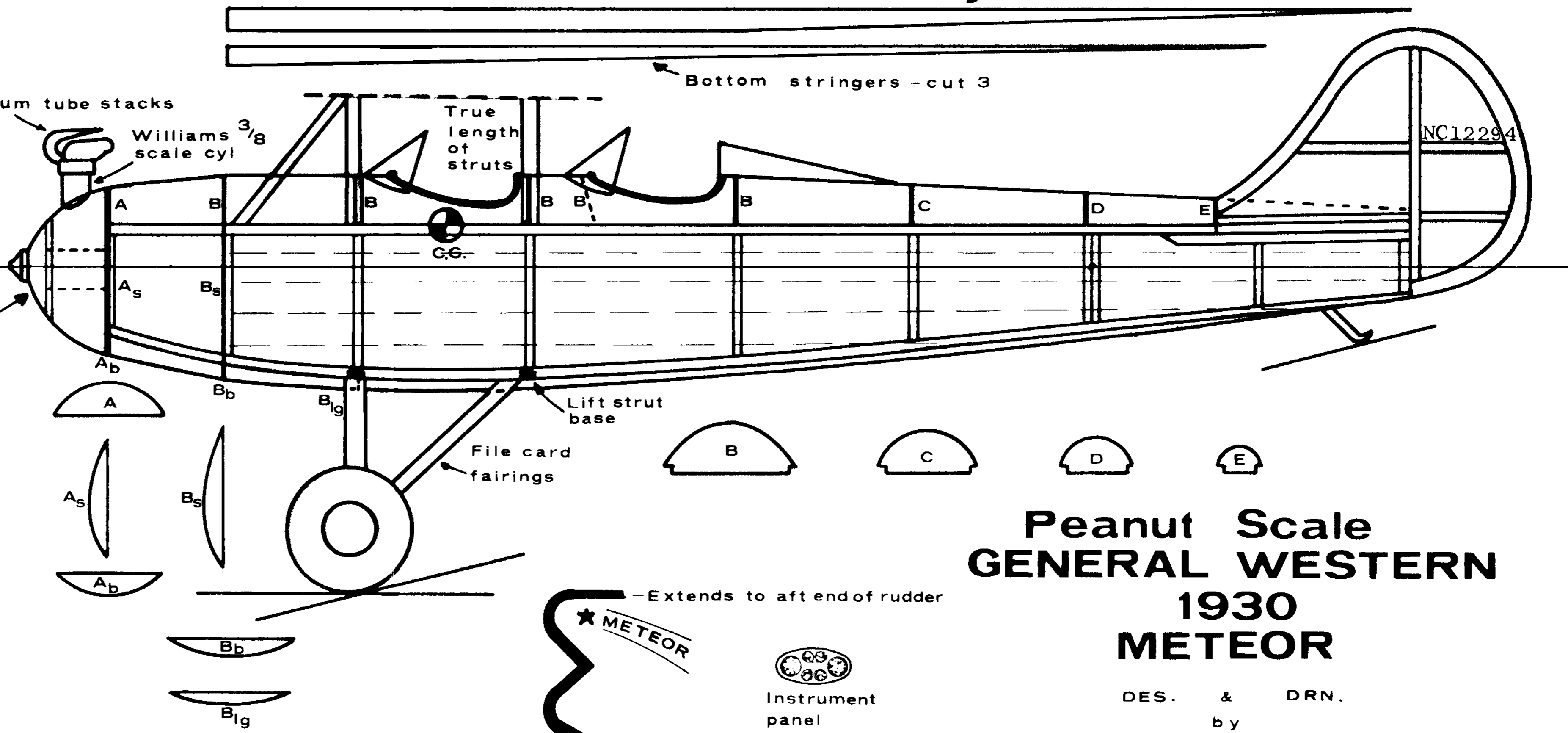
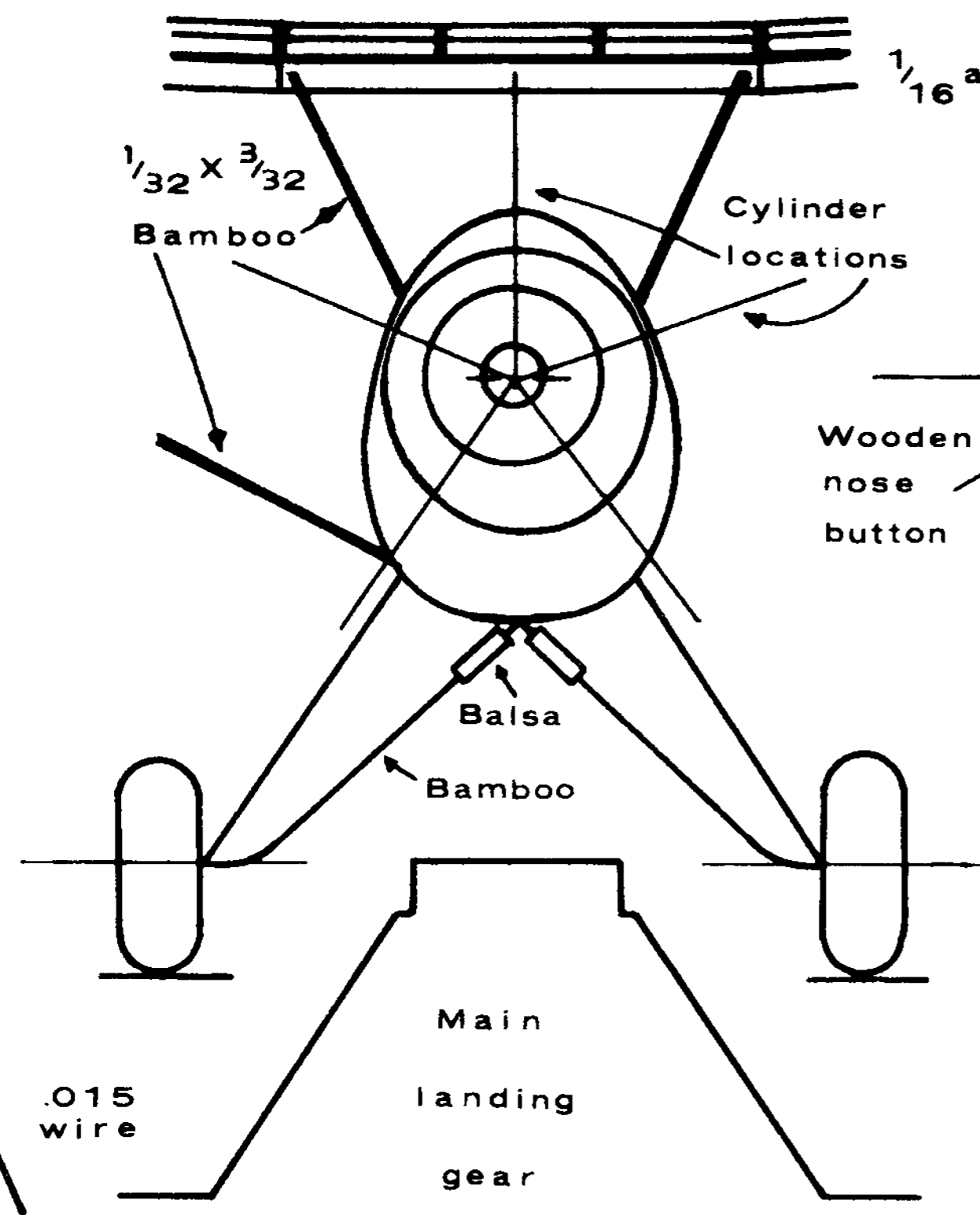
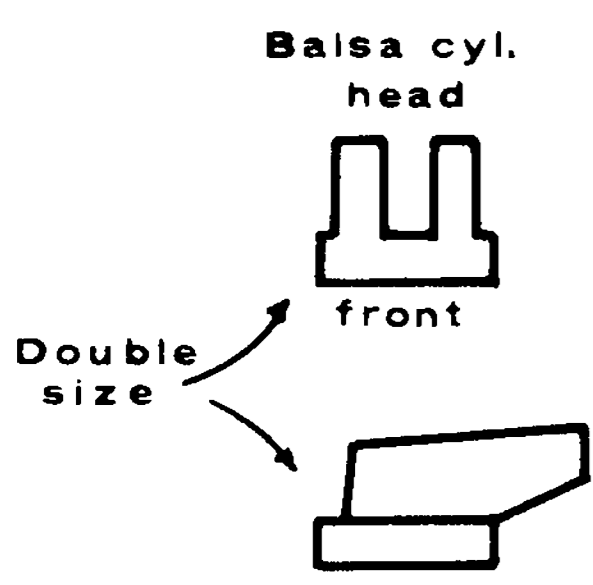
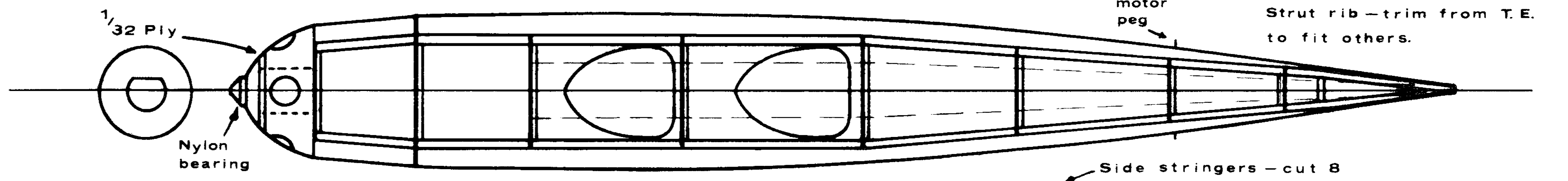
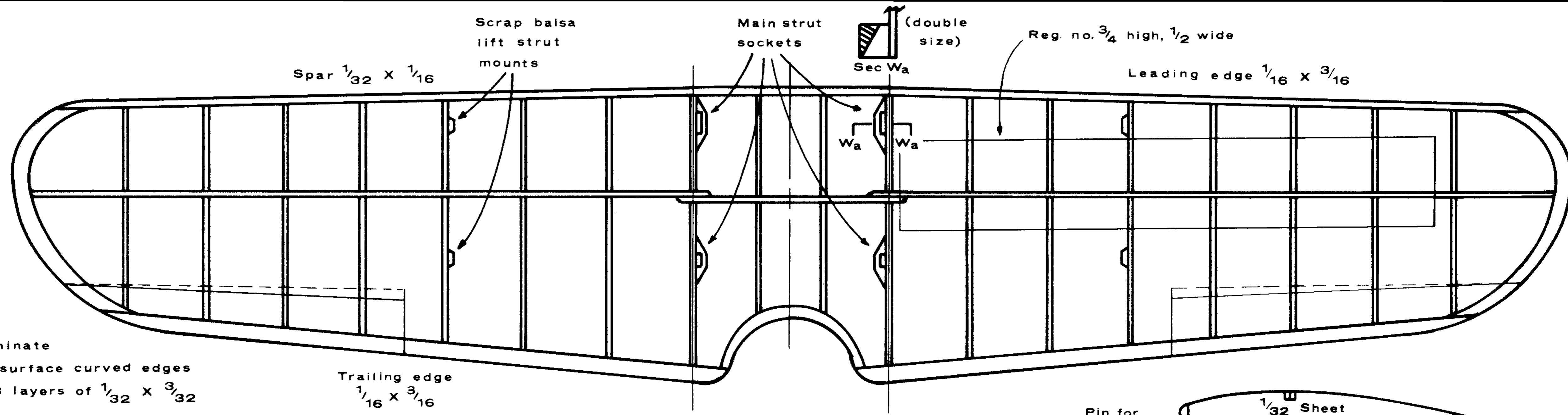
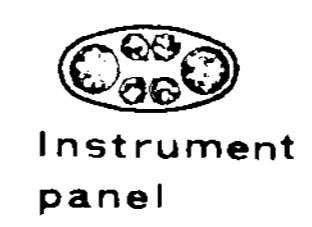

# Peanut Scale GENERAL WESTERN 1930 METEOR

DES. & DRN.  
by  
A. A. LIDBERG