

## THE BLU-CITABRIA 25" WINGSPAN

SCALE AMERICAN CHAMPION CITABRIA  
BASED UPON THE BLU-BABY PRIMARY  
TRAINER BY TONY 65X55

*NOTE: THESE PLANS ARE INTENDED FOR PERSONAL  
USE. COMMERCIAL SALE AND USAGE ARE NOT  
PERMITTED.*

DESIGN BY: PHILIPA_240SX
VERSION: 1.0B
STATUS: TEST & ISSUED FOR CONS.
DATE: JUL 12 2010
POWER: INFINITE A1705-1800, PROP 7X3.5 GWS, 6A ESC
ALT. MOTOR: HXM 1811-2000, TURNIGY 2204/15
BATTERY: 2S 350MAH LIPO
SERVOS: 2X 5GRAM
CHANNELS: 3CH - RET
AUW: 5 OZ (140 GRAMS)

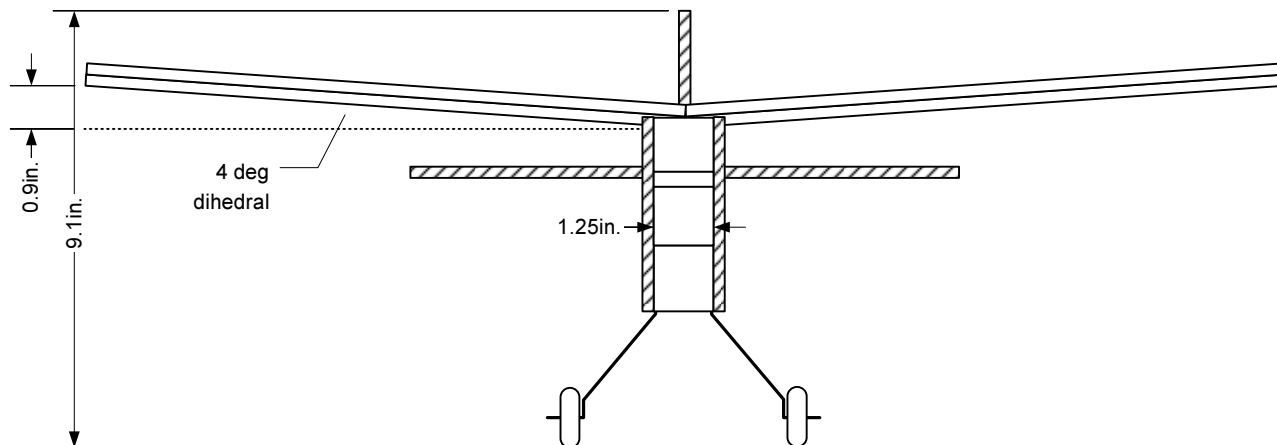



WING - BOTTOM X2

This technical drawing shows the bottom view of a wing and fuselage. The wing is represented by a large, elongated shape with a curved leading edge on the left and a tapered trailing edge on the right. The fuselage is shown as a smaller, tapered shape below the wing. The drawing includes three registration marks (crosshairs) at the corners: top-right, bottom-left, and bottom-right. The text 'WING - BOTTOM X2' is centered within the wing's outline, and 'FUSE BOTTOM' is centered within the fuselage's outline.

FUSE BOTTOM

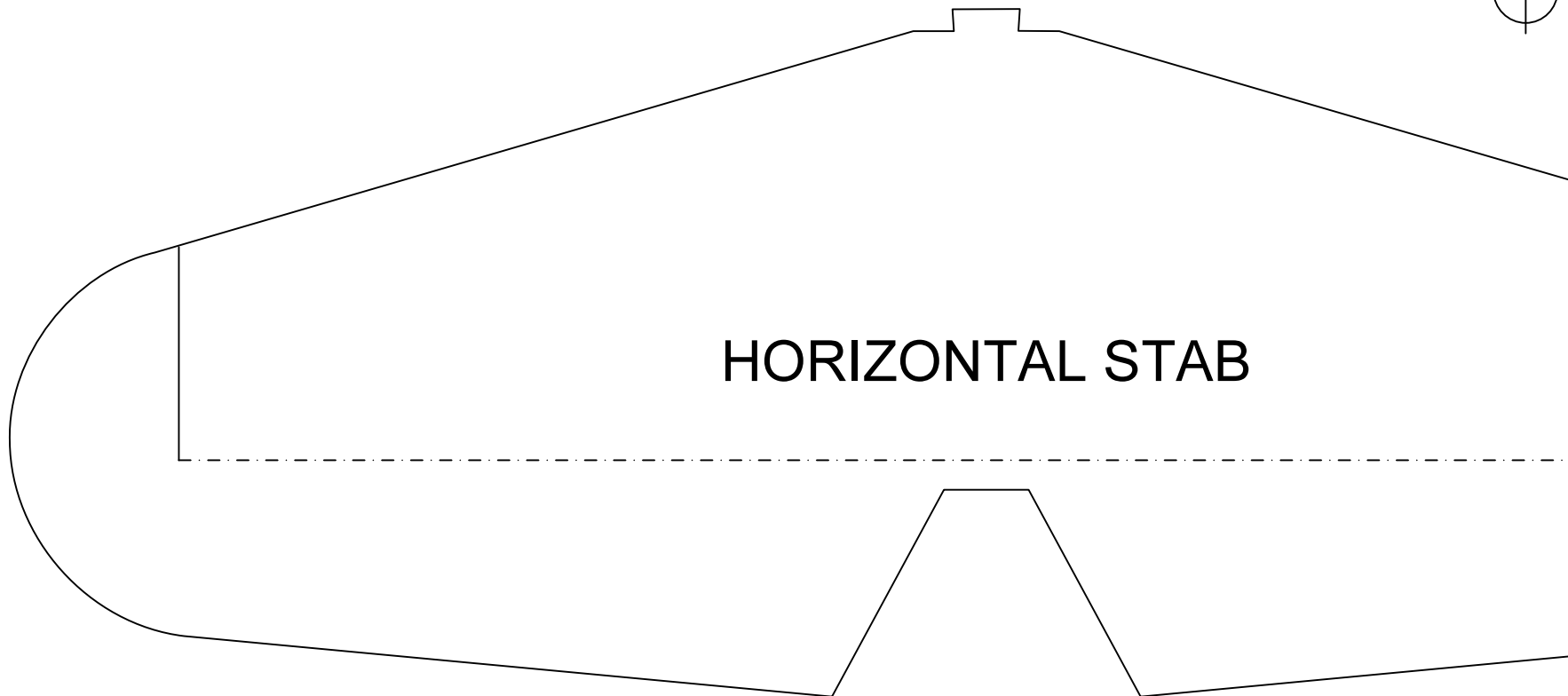

HORIZONTAL STAB

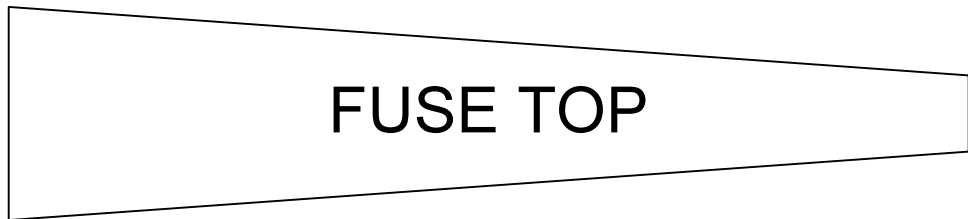

FUSE TOP



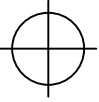

WING SPAR DOUBLER X2

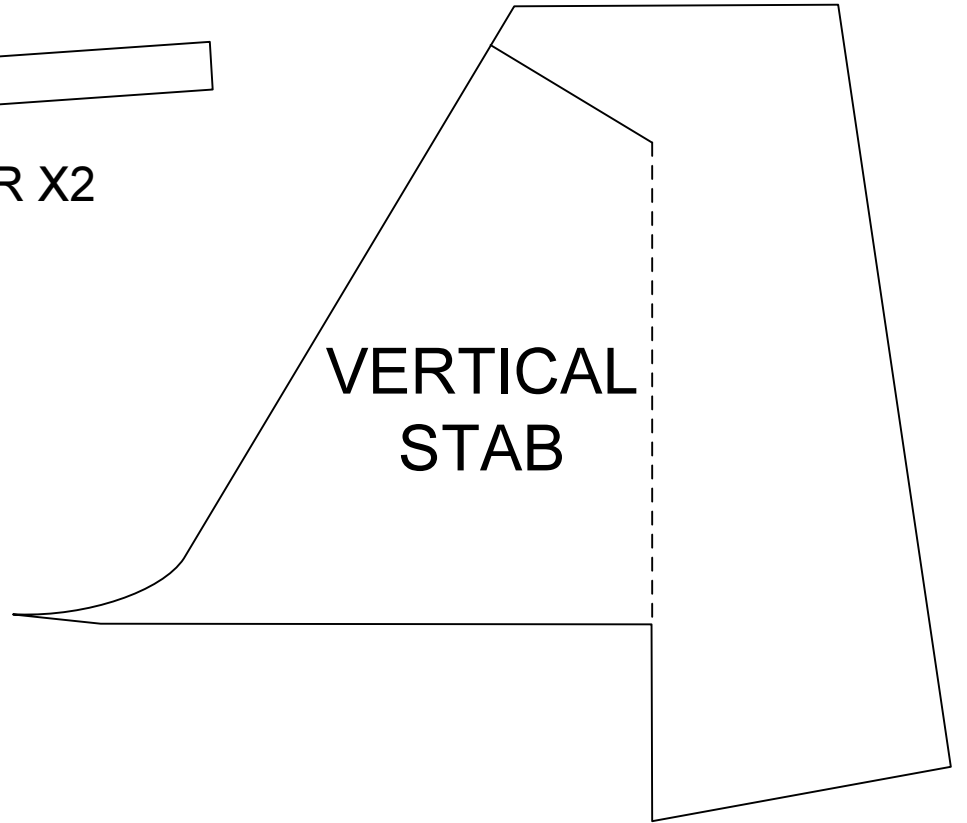
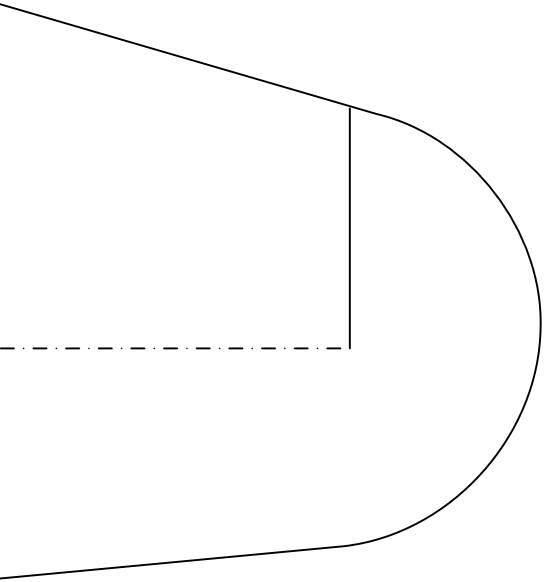

VERTICAL  
STAB

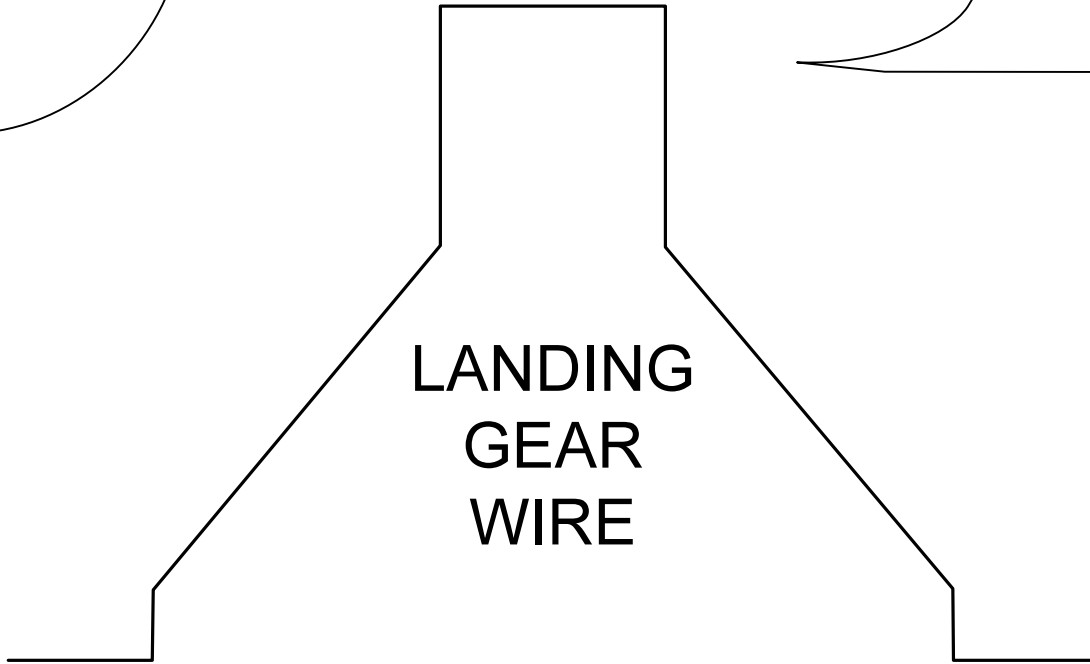

LANDING  
GEAR  
WIRE





WING - KFM TOP STEP X2

This technical drawing shows a top-down view of a wing section, labeled 'WING - KFM TOP STEP X2'. The wing is positioned on the left side of the image. To its right, a portion of the fuselage is shown, labeled 'FUSELAGE SIDE'. The fuselage section includes a rectangular window with rounded corners. The drawing is enclosed in a rectangular frame with rounded corners on the left side. Three registration marks, consisting of a circle with a crosshair, are located at the top-left, top-right, and bottom-right corners of the drawing area.

FUSELAGE SIDE

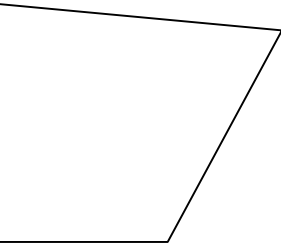
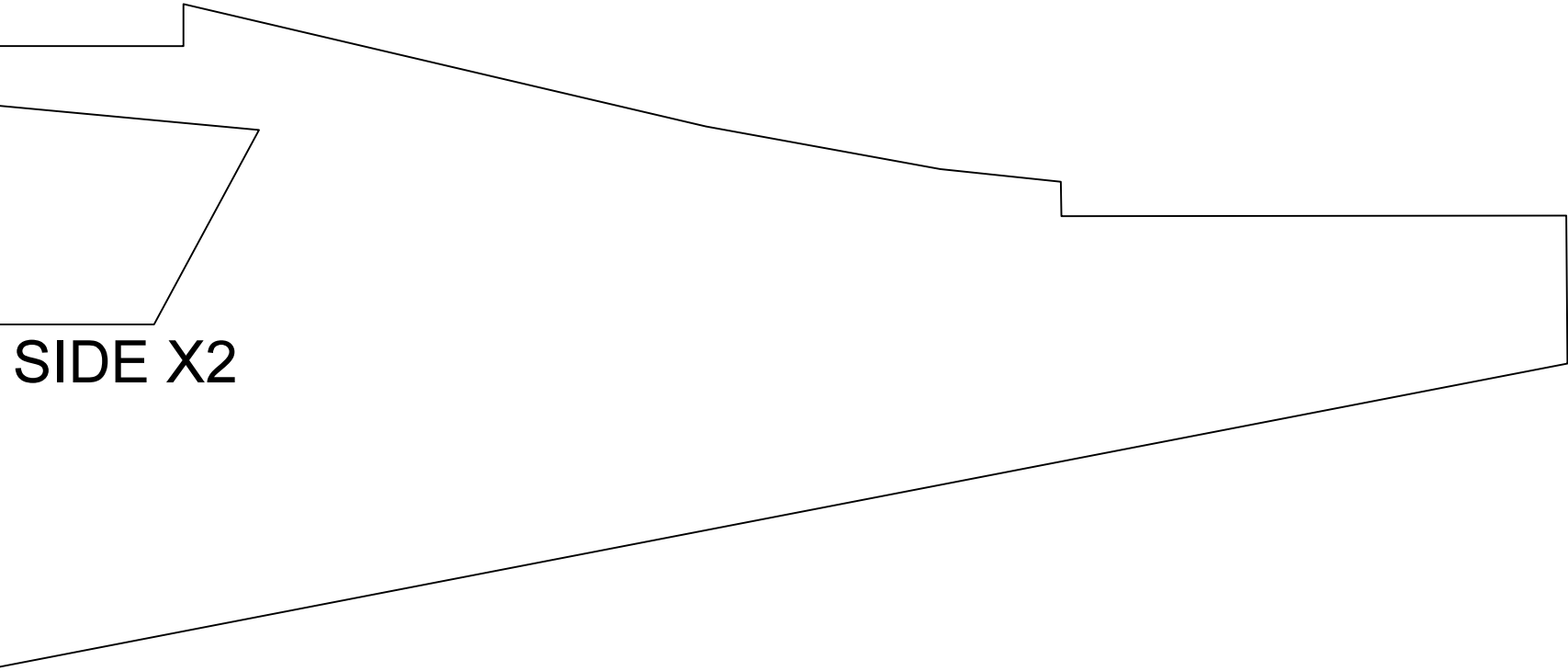
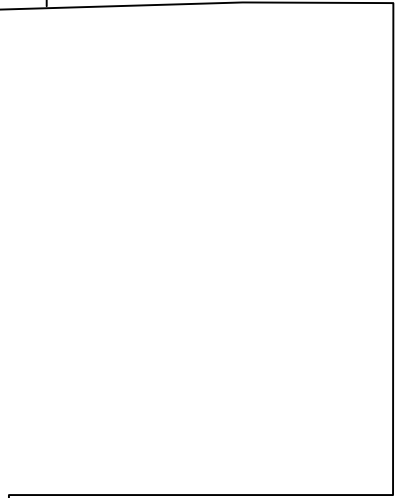
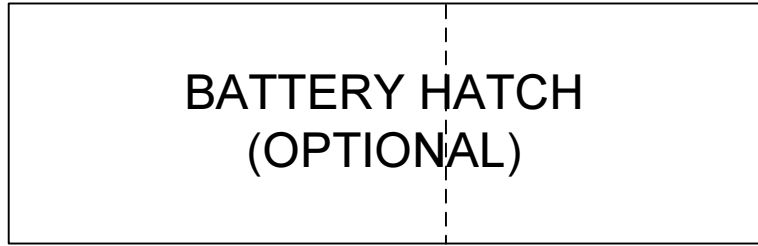
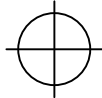

**SIDE X2**

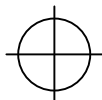
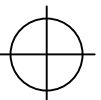

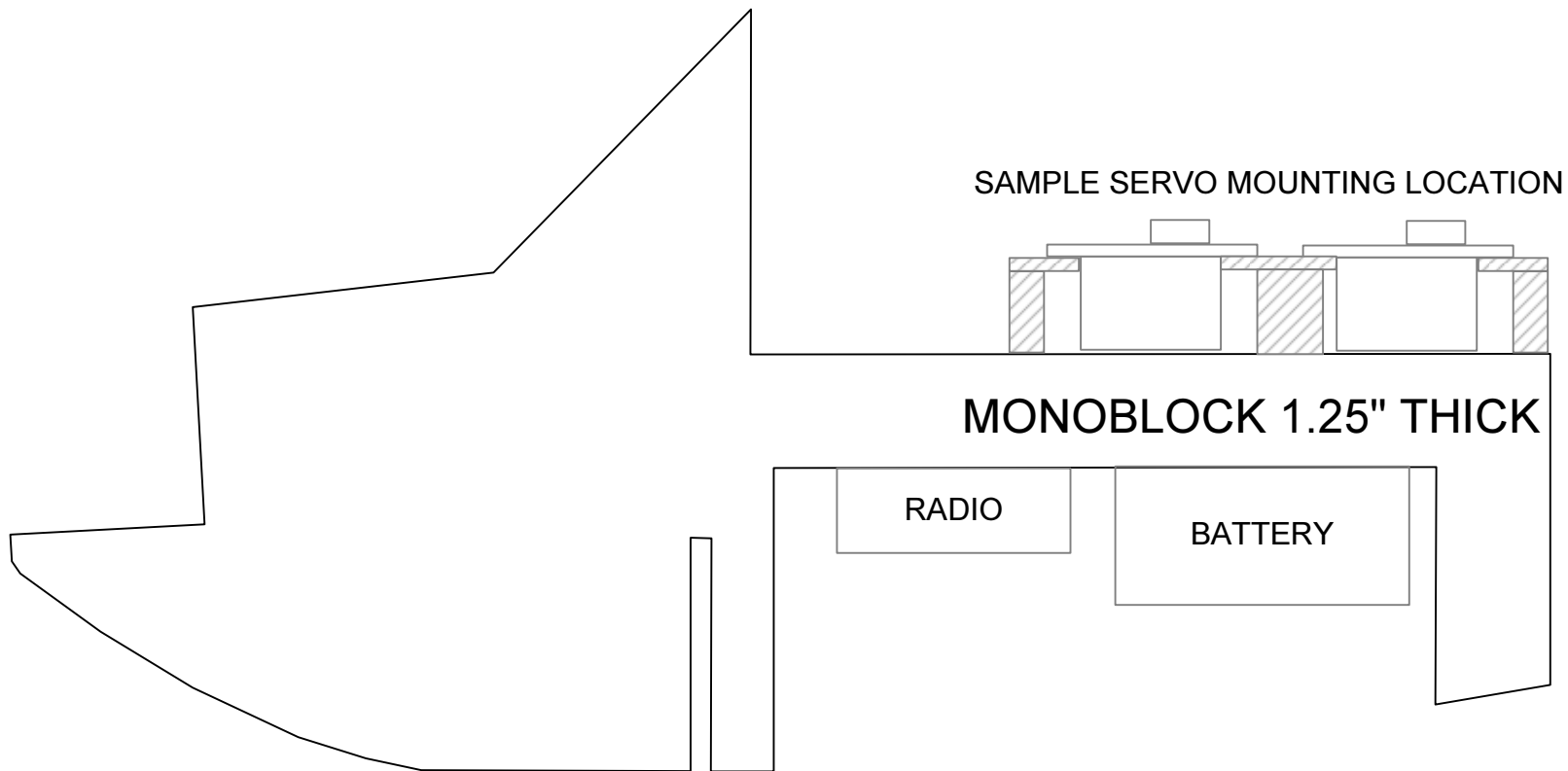

<b>THE BLU-CITABRIA</b> <b>25" WINGSPAN</b>	DESIGN BY: PHILIPA_240SX
	VERSION: 1.0B
SCALE AMERICAN CHAMPION CITABRIA BASED UPON THE BLU-BABY PRIMARY TRAINER BY TONY 65X55	STATUS: TEST FLOWN AND ISSUED FOR CONS.
	DATE: JUL 12 2010
	POWER: INFINITE A1705-1800, PROP 7X3.5 GWS, 6A ESC
<i>NOTE: THESE PLANS ARE INTENDED FOR          PERSONAL USE. COMMERCIAL SALE AND          USAGE ARE NOT PERMITTED.</i>	ALT. MOTOR: HXM 1811-2000, TURNIGY 2204/15
	BATTERY: 2S 350MAH LIPO
	SERVOS: 2X 5GRAM
	CHANNELS: 3CH - RET